

ECN REVISIONS			
REV.	DESCRIPTION	DATE	APPROVED
△			
△			

STEP1 :
將Antenna、LAN cabel、Screw Pack、register card、MFR/EU Importer(partial) doc、Qulck Start Guide 以上物件皆放入彩盒下層內，如圖FIGURE A-1。

STEP2 :
將內隔板折好並放入彩盒內，且放入Vigor2136本體放入左方隔板上，如圖FIGURE A-2。

STEP3 :
將INNER BOX 放置在Vigor2136本體上將Vigor2136本體固定住，如圖FIGURE A-2。

STEP4 :
將Power Adapter 放置在右方彩盒隔板內，如圖FIGURE A-2。

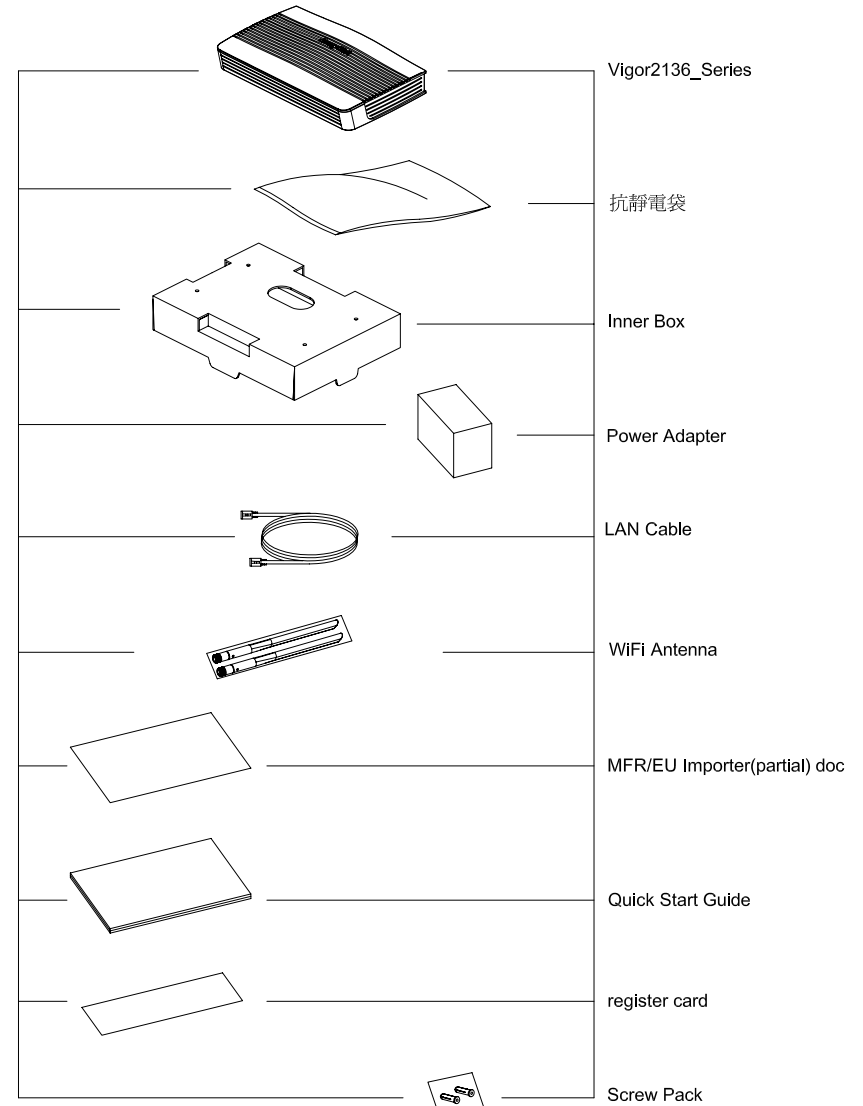

FIGURE A-1

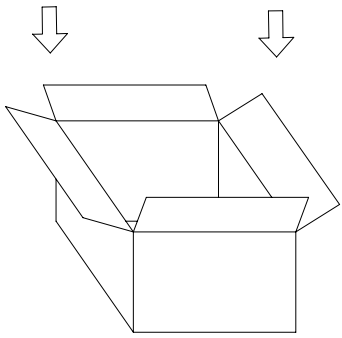
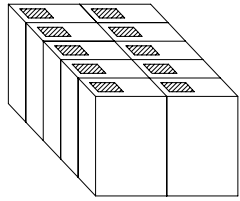

FIGURE B-1

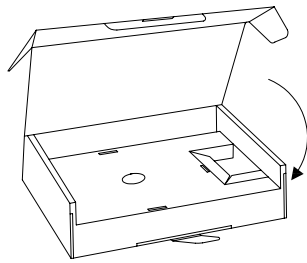

FIGURE A-2

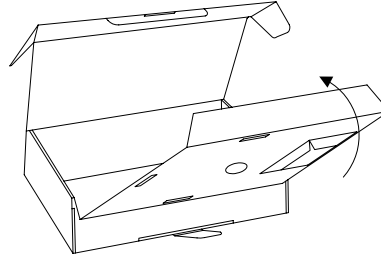

FIGURE A-1

Color Box for Vigor2136 Series

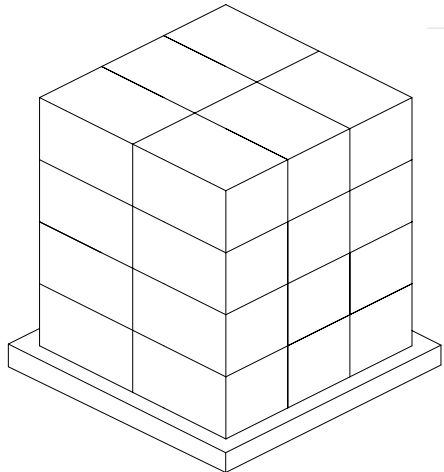

FIGURE B-2

STEP1 :
將彩盒以兩排每排各5 pcs放入外箱裡，共裝10 pcs為一箱(彩貼朝上放置)，如圖FIGURE B-1 之圖示。

STEP2 :
將外箱放置在棧板上，一層6箱(3x2)堆置在棧板上，一個棧板上放置約4~6層，(出海運或空運請依據個別的高度限制)如圖FIGURE B-2 之圖示。

居易科技 DrayTek		No. 26, Fu Shing Road., HuKou, Hsin-Chu Industrial Park, Hsin-Chu, Taiwan 303 R.O.C TEL: 886-3-5972727 FAX: 886-3-5972121 http://www.draytek.com			Tolerances unless otherwise specified Angle: $\pm 1/2^\circ \pm 1'$ $500 \sim \pm 0.4 \pm 0.5$ $100 \sim 500 \pm 0.3 \pm 0.5$ $200 \sim 300 \pm 0.25 \pm 0.3$ $120 \sim 200 \pm 0.2 \pm 0.25$ $60 \sim 120 \pm 0.15 \pm 0.2$ $10 \sim 60 \pm 0.1 \pm 0.15$ $0 \sim 10 \pm 0.05 \pm 0.1$ CLASS A B	
Model:	Vigor2136 Series	Drawing No.:	N/A	Part No.:	N/A	
Part name:	包裝規範	Drawn:	Tony Chiu	DATE:	2024.03.27	
Material:	N/A	Checked:		DATE:		
Surface Treatment:	N/A	Approved:		DATE:		
		Rev.:	0	Sheet:	1 of 4	

ECN REVISIONS			
REV.	DESCRIPTION	DATE	APPROVED
△1			
△2			

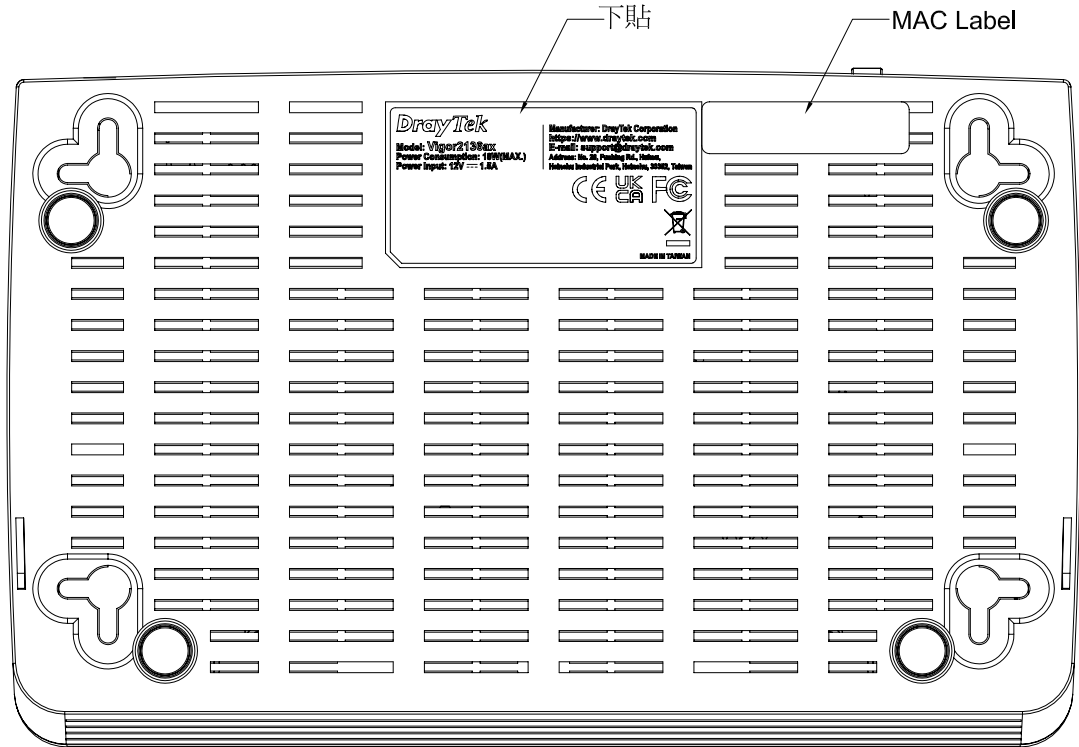

FIGURE A-3:

或為Vigor2136 Series 的其它
延伸機種

S/N詳細印製內容
-請參照規範

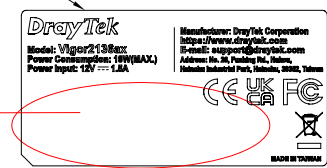

FIGURE A-1 :
59mmx30mm 下貼 FOR Vigor2136ax

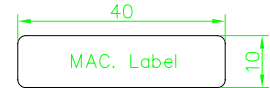
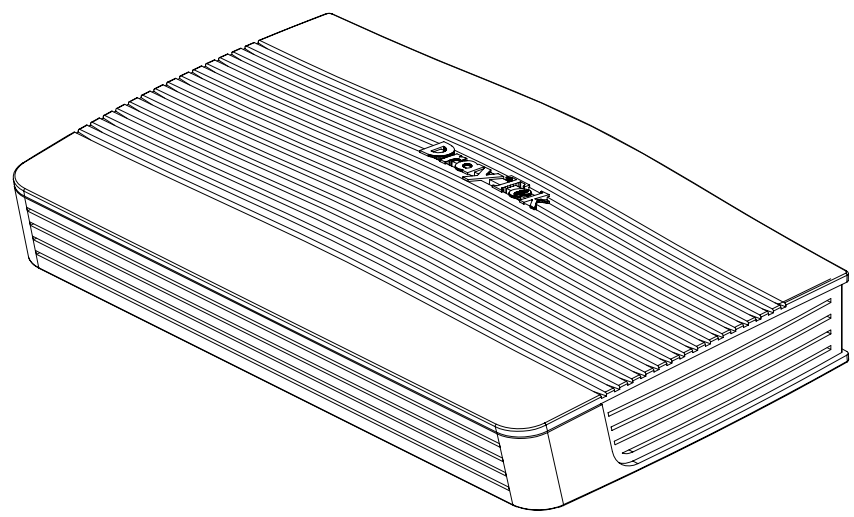

FIGURE A-2 :
40 mm X 10mm 半成品序號標籤。



Notes:

- 1：下貼標籤尺寸為59x30mm，如圖示 FIGURE A-1，S/N -上條碼機列印。
- MAC label-尺寸為 40x10mm(白色規格標籤)，如圖示 FIGURE A-2。
- 2：先將下貼標籤貼附在下蓋方框上面，在將MAC Label 貼於下貼周邊適當位置，如圖示 FIGURE A-3。

居易科技 No. 26, Fu Shing Road., HuKou, Hsin-Chu Industrial Park, Hsin-Chu, Taiwan 303 R.O.C TEL: 886-3-5972727 FAX: 886-3-5972121 http://www.draytek.com		Tolerances unless otherwise specified Angle ±1/2° ±1° 500 ~ ±0.4 ±0.5 300 ~ 500 ±0.3 ±0.5 200 ~ 300 ±0.25 ±0.3 120 ~ 200 ±0.2 ±0.25 60 ~ 120 ±0.15 ±0.2 10 ~ 60 ±0.1 ±0.15 0 ~ 10 ±0.05 ±0.1 CLASS A B	
Model: Vigor2136 Series	Drawing No. N/A	Part No. N/A	
Part name: 包裝規範	Drawn: Tony Chiu	Date: 2024.03.27	UNIT: MM
Material: N/A	Surface Treatment: N/A	Checked:	Date:
	Approved:	Date:	Rev. 0 Sheet: 2of4

ECN REVISIONS			
REV.	DESCRIPTION	DATE	APPROVED
△1			
△2			

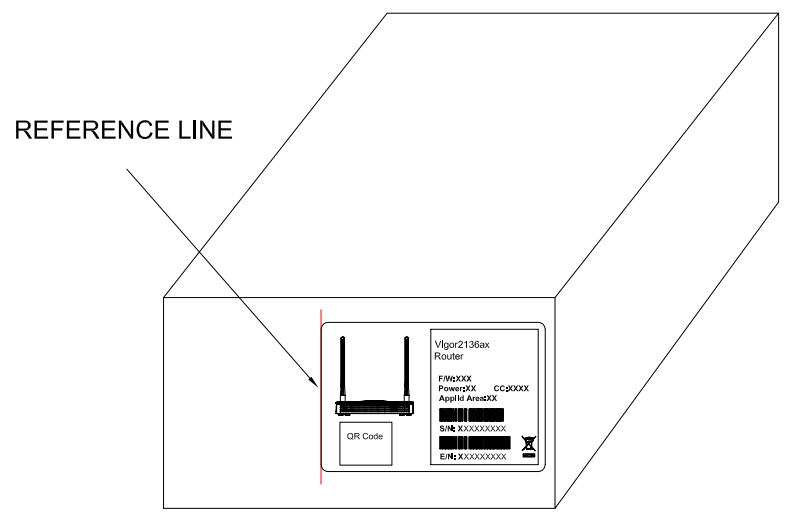

FIGURE C-2 : REAR VIEW of Vigor2136 Series COLOR BOX

彩貼詳細印製內容-請參照規範

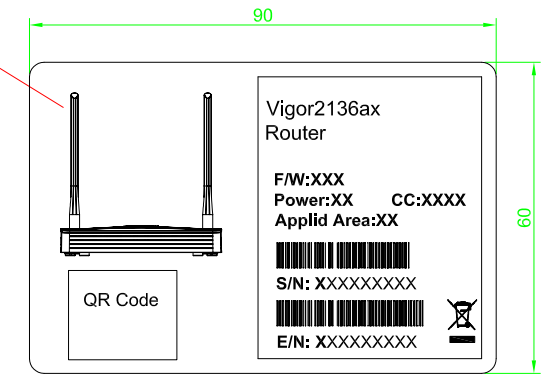

FIGURE C-1

- Notes:
- 1 : 彩盒貼紙尺寸為90 mmx60 mm，如圖 FIGURE C-1 。
 - 2 : 貼黏彩盒標籤時，盡可能對齊Reference Line 並水平垂直於邊線，如圖 FIGURE C-2 。

		No. 26, Fu Shing Road., HuKou, Hsin-Chu Industrial Park, Hsin-Chu, Taiwan 303 R.O.C TEL: 886-3-5972727 FAX: 886-3-5972121 http://www.draytek.com		Tolerances unless otherwise specified	
Model: Vigor2136 Series		Drawing No. N/A	Part No. N/A	Angle $\pm 1/2^\circ$ $\pm 1^\circ$	± 0.5
Part name: 包裝規範		Drawn: Tony Chiu	Date: 2024.03.27	UNIT: MM	± 0.4 ± 0.5
Material: N/A		Checked: Date:	Size: A3	Scale: 1:1	± 0.3 ± 0.3
Surface Treatment: N/A		Approved: Date:	Rev. 0	Sheet: 3of4	± 0.2 ± 0.25
					± 0.1 ± 0.15
					± 0.1 ± 0.1
					± 0.05 ± 0.1
					CLASS A B

ECN REVISIONS			
REV.	DESCRIPTION	DATE	APPROVED
△1			
△2			

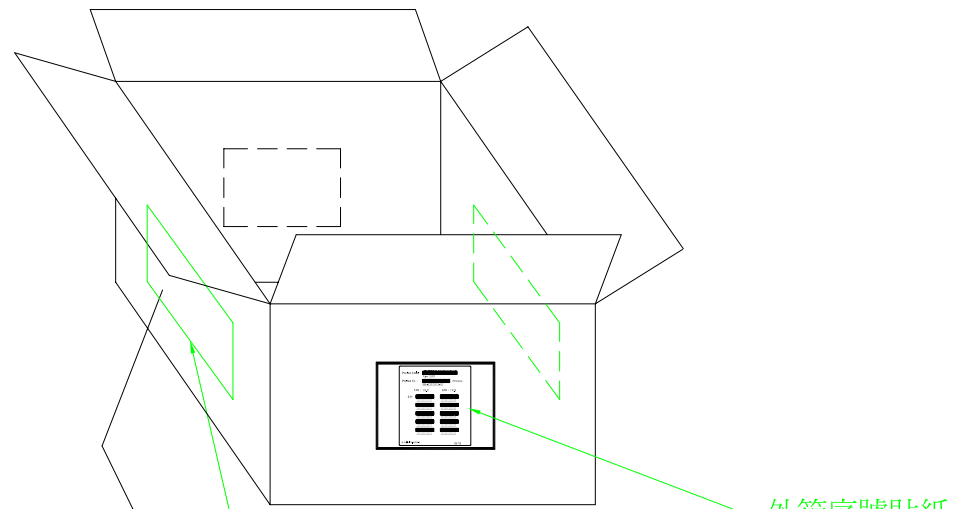

FIGURE D-3

外箱序號貼紙

外箱綠色貼紙

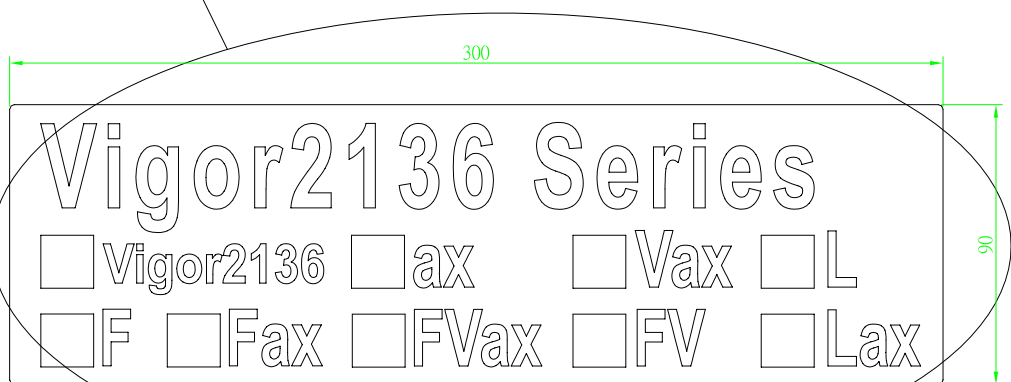

FIGURE D-2外箱綠色貼紙

或為Vigor2136 Series
的其它延伸機種

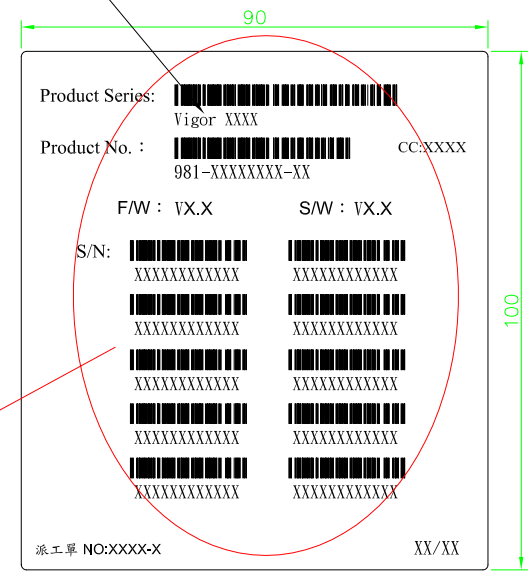

FIGURE D-1

外箱序號貼紙-詳細
印製內容請參照規
範

Notes:

- 1 : 外箱綠色貼紙:尺寸為300mmX90mm,如圖示Figure D-2,在方框內用四方形章蓋選機種的品名,並黏貼於指定的印刷方格中,且對齊方格之水平及垂直方向線條,如圖示Figure D-3。
- 2 : 將90mmx100mm外箱序號貼紙於外箱上,如圖示Figure D-1,並黏貼於指定的印刷方格中,且對齊方格之水平及垂直方向線條。如圖示Figure D-3。

居易科技 DrayTek		No. 26, Fu Shing Road., HuKou, Hsin-Chu Industrial Park, Hsin-Chu, Taiwan 303 R.O.C TEL: 886-3-5972727 FAX: 886-3-5972121 http://www.draytek.com			Tolerances unless otherwise specified	
Model: Vigor2136 Series		Drawing No. N/A	Part No. N/A		Angle ±1/2' ±1"	
Part name: 包裝規範		Drawn: Tony Chiu Date: 2024.03.27	Date:	UNIT: MM		500 ~ ±0.4 ±0.5 300 ~ 500 ±0.3 ±0.5 200 ~ 300 ±0.25 ±0.3
Material: N/A		Surface Treatment: N/A	Checked:	Date:	Size: A3	Scale: 1:1
		Approved:	Date:	Rev. 0	Sheet: 4of4	120 ~ 200 ±0.2 ±0.25 60 ~ 120 ±0.15 ±0.2 10 ~ 60 ±0.1 ±0.15 0 ~ 10 ±0.05 ±0.1
						CLASS A B