

VigorAP 962C

802.11ax Ceiling-mount Access Point

Quick Start Guide

Version: 1.3

Firmware Version: V5.1.0

(For future update, please visit DrayTek web site)

Date: 31 March, 2026

Intellectual Property Rights (IPR) Information

| | |
|-------------------|--|
| Copyrights | © All rights reserved. This publication contains information that is protected by copyright. No part may be reproduced, transmitted, transcribed, stored in a retrieval system, or translated into any language without written permission from the copyright holders. |
| Trademarks | The following trademarks are used in this document: <ul style="list-style-type: none">● Microsoft is a registered trademark of Microsoft Corp.● Windows, Windows 8, 10, 11 and Explorer are trademarks of Microsoft Corp.● Apple and Mac OS are registered trademarks of Apple Inc.● Other products may be trademarks or registered trademarks of their respective manufacturers. |

Safety Instructions and Approval

| | |
|----------------------------|--|
| Safety Instructions | <ul style="list-style-type: none">● Read the installation guide thoroughly before you set up the device.● The device is a complicated electronic unit that may be repaired only by authorized and qualified personnel. Do not try to open or repair the device yourself.● Do not place the device in a damp or humid place, e.g. a bathroom.● Do not stack the devices.● The device should be used in a sheltered area, within a temperature range of 0 to +40 Celsius.● Do not expose the device to direct sunlight or other heat sources. The housing and electronic components may be damaged by direct sunlight or heat sources.● Do not deploy the cable for LAN connection outdoor to prevent electronic shock hazards.● Do not power off the device when saving configurations or firmware upgrades. It may damage the data in a flash. Please disconnect the Internet connection on the device before powering it off when a TR-069/ ACS server manages the device.● Keep the package out of reach of children.● When you want to dispose of the device, please follow local regulations on conservation of the environment. |
| Warranty | We warrant to the original end user (purchaser) that the device will be free from any defects in workmanship or materials for a period of two (2) years from the date of purchase from the dealer. Please keep your purchase receipt in a safe place as it serves as proof of date of purchase. During the warranty period, and upon proof of purchase, should the product have indications of failure due to faulty workmanship and/or materials, we will, at our discretion, repair or replace the defective products or components, without charge for either parts or labor, to whatever extent we deem necessary to restore the product to proper operating condition. Any replacement will consist of a new or re-manufactured functionally equivalent product of equal value, and will be offered solely at our discretion. This warranty will not apply if the product is modified, misused, tampered with, damaged by an act of God, or subjected to abnormal working conditions. The warranty does not cover the bundled or licensed software of other vendors. Defects which do not significantly affect the usability of the product will not be covered by the warranty. We reserve the right to revise the manual and online documentation and to make changes from time to time in the contents hereof without obligation to notify any person of such revision or changes. |



Declaration of Conformity

Hereby, DrayTek Corporation declares that the equipment type VigorAP 962C is in compliance with Radio Equipment Directive 2014/53/EU, Low Voltage Directive 2014/35/EU and RoHS 2011/65/EU.

The full text of the EU declaration of conformity is available at the following internet address:

<https://fw.draytek.com.tw/VigorAP%20962C/Document/CE/>

Manufacturer: DrayTek Corp.

Address: No.26, Fushing Rd., Hukou, Hsinchu Industrial Park, Hsinchu 303, Taiwan

Product: VigorAP 962C

Frequency Information for Europe area:

| | |
|---|--|
| 2.4GHz WLAN | 2412MHz - 2472 MHz, max. TX power: 19.23 dBm |
| 5GHz WLAN | 5160MHz - 5340 MHz, max. TX power: 22.92 dBm 5480MHz - 5720 MHz, max. TX power: 29.94 dBm |
|  | Requirements in AT/BE/BG/CZ/DK/EE/FR/DE/IS/IE/IT/EL/ES/ CY/LV/LI/LT/LU/HU/MT/NL/NO/PL/PT/RO/SI/SK/TR/FI/SE/CH/HR/UK(NI). 5150MHz-5350MHz is for indoor use only. |

This product is designed for 2.4GHz and 5GHz WLAN network throughout the EC region.



Declaration of Conformity

Hereby, DrayTek Corporation declares that the equipment type VigorAP 962C is in compliance with the Radio Equipment Regulations 2017 (SI 2017 No.1206), The Electrical Equipment (Safety) Regulations 2016 (SI 2016 No.1101), and The Restriction of the Use of Certain Hazardous Substances in Electrical and Electronic Equipment Regulations 2012 (SI 2012 No. 3032).

The full text of the UKCA Declaration of Conformity is available at the following internet address:

<https://fw.draytek.com.tw/VigorAP%20962C/Document/CE/>

Manufacturer: DrayTek Corp.

Address: No.26, Fushing Rd., Hukou, Hsinchu Industrial Park, Hsinchu 303, Taiwan

Product: VigorAP 962C

Frequency Information for UK area:

| | |
|---|--|
| 2.4GHz WLAN | 2412MHz - 2472 MHz, max. TX power: 19.23 dBm |
| 5GHz WLAN | 5160MHz - 5340 MHz, max. TX power: 22.92 dBm 5480MHz - 5720 MHz, max. TX power: 29.94 dBm |
|  | Requirements in UK. 5150MHz-5350MHz is for indoor use only. |

This product is designed 2.4GHz and 5GHz WLAN network use in the UK & Ireland.

Importer UK - CMS Distribution Limited, 15 Worship Street, London, EC2A 2DT

Ireland - CMS Distribution Limited, Bohola Road, Kiltimagh, Co Mayo, Ireland



UK PSTI STATEMENT OF COMPLIANCE

We, DrayTek Corp., office at No.26, Fushing Rd., Hukou, Hsinchu Industrial Park, Hsinchu 303, Taiwan, declare under our sole responsibility that the product

The full text of the PSTI Declaration of Conformity is available at the following internet address:
<https://fw.draytek.com.tw/UK/PSTI/>

- Product name: 802.11ax Ceiling-mount Access Point
- Model number: VigorAP 962C
- Manufacturer: DrayTek Corp.
- Address: No.26, Fushing Rd., Hukou, Hsinchu Industrial Park, Hsinchu 303, Taiwan

is in conformity with the relevant UK Statutory Instruments: The Product Security and Telecommunications Infrastructure (Security Requirements for Relevant Connectable Products) Regulations 2023 (“Security Requirements”).

| Standard | Version |
|--|------------------------------------|
| The Product Security and Telecommunications Infrastructure Regulations | 2023 Schedule 1 |
| Support Period | 3 years after the EOS notification |

Please note that this statement of compliance, including the Defined Support Period stated herein, is only applicable to products sold in the UK.

This Statement of Compliance is retained by DrayTek for 10 years after date of issue.

Hsinchu

(place)

25th Mar., 2024

(date)

Alan Wen

Chief Executive Officer, CEO

(Legal Signature)



Regulatory Information

Federal Communication Commission Interference Statement

This equipment has been tested and found to comply with the limits for a Class B digital device, pursuant to Part 15 of the FCC Rules. These limits are designed to provide reasonable protection against harmful interference in a residential installation. This equipment generates, uses and can radiate radio frequency energy and, if not installed and used in accordance with the instructions, may cause harmful interference to radio communications. However, there is no guarantee that interference will not occur in a particular installation. If this equipment does cause harmful interference to radio or television reception, which can be determined by turning the equipment off and on, the user is encouraged to try to correct the interference by one of the following measures:

- Reorient or relocate the receiving antenna.
- Increase the separation between the equipment and receiver.
- Connect the equipment into an outlet on a circuit different from that to which the receiver is connected.
- Consult the dealer or an experienced radio/TV technician for help.

This device complies with Part 15 of the FCC Rules. Operation is subject to the following two conditions:

- (1) This device may not cause harmful interference, and
- (2) This device may accept any interference received, including interference that may cause undesired operation.

| | | | | |
|--------------------------|----------------|--|--------|-------------------|
| USA Local Representative | Company name | ABP International Inc. | | |
| | Address | 13988 Diplomat Drive Suite 180 Dallas TX 75234 | | |
| | ZIP Code | 75234 | E-mail | henry@abptech.com |
| | Contact Person | Mr. Henry N Castillo | Tel. | (972)831-1600 140 |

Caution

- Any changes or modifications not expressly approved by the grantee of this device could void the user's authority to operate the equipment.
- Any changes or modifications not expressly approved by the party responsible for compliance could void the user's authority to operate this equipment.
- This transmitter must not be co-located or operating in conjunction with any other antenna or transmitter.
- Radiation Exposure Statement: This device complies with FCC radiation exposure limits set forth for an uncontrolled environment and it also complies with Part 15 of the FCC RF Rules. This equipment must be installed and operated in accordance with provided instructions and the antenna(s) used for this transmitter must be installed to provide a separation distance of at least 20 cm from all persons and must not be co-located or operating in conjunction with any other antenna or transmitter. End-users and installers must be provided with antenna installation instructions and consider removing the no-collocation statement.

External Power Supply ErP Information

| | | 1 | 2 | 3 | 4 | 5 |
|---|----------------------------|--|--|---|---|--|
| A | Manufacturer | DVE | DVE | AMIGO | AMIGO | TOPOW Electronics Co. |
| B | Address | No.5, Pao-Kao Road, Hsin-Tien, New Taipei City 231, Taiwan | No.5, Pao-Kao Road, Hsin-Tien, New Taipei City 231, Taiwan | No.20, Qianyang First Road, Yun-Mao-Tsun, San Xing, Zhongshan, Guangdong, China | No.20, Qianyang First Road, Yun-Mao-Tsun, San Xing, Zhongshan, Guangdong, China | No.8 Xinxing Industrial Park, Xinhe Village, Fuyong Street, Baoan District, Shenzhen, Guangdong, China |
| C | Model identifier | DSA-12PF09-12 FUK | DSA-18PFR-12 FUK | AMS159A-1201000FB | AMS2000-1202000FV | TPA259-18120-EU-22 086 |
| | | DSA-12PF09-12 FEU DSA-12PF11-12 FEU | DSA-18PFR-12 FEU | | AMS2000-1202000FB | TPA259-18120-UK-23 091 |
| D | Input voltage | 100-240V | 100-240V | 100-240V | 100-240V | 100-240V |
| E | Input AC frequency | 50/60Hz | 50/60Hz | 50/60Hz | 50/60Hz | 50/60Hz |
| | Output voltage DC | 12.0V | 12.0V | 12.0V | 12.0V | 12.0V |
| F | Output current | 1.0A | 1.5A | 1.0A | 2.0A | 1.5A |
| G | Output power | 12.0W | 18.0W | 12.0W | 24.0W | 18.0W |
| H | Average active efficiency | 84% | 85.5% | 86.96% | 86.2% | 85.21% |
| I | Efficiency at low load 10% | 79.3% | 83.7% | 77.5% | 79.1% | 80.1% |
| J | No-load power consumption | 0.06W | 0.07W | 0.10W | 0.10W | 0.1W |

*The external power supply used for each product will be model dependent.

For more update, please visit www.draytek.com.

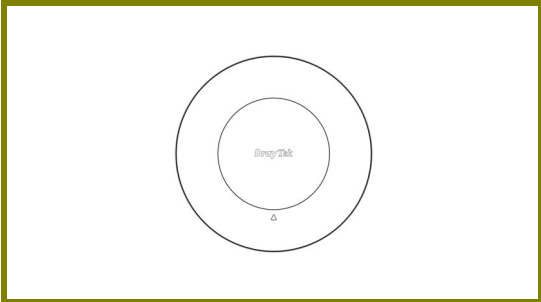

Table of Contents

| | |
|---|-----------|
| 1. Package Content..... | 8 |
| 2. Panel Explanation..... | 9 |
| 3. Installation | 10 |
| 3.1 Ceiling-mount Installation (from A to C)..... | 10 |
| 3.2 Wall-mount Installation (from A to C)..... | 10 |
| 4. Connection and Configuration | 11 |
| 4.1 Notifications for Hardware Connection..... | 11 |
| 4.2 Web Configurations..... | 12 |
| 5. Customer Service..... | 15 |
| Be a Registered Owner..... | 15 |
| Firmware & Tools Updates | 15 |

1. Package Content

Take a look at the package content. If there is anything missed or damaged, please contact DrayTek or dealer immediately.



Main Unit

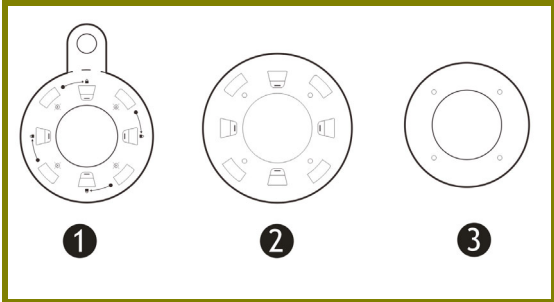

Mount brackets

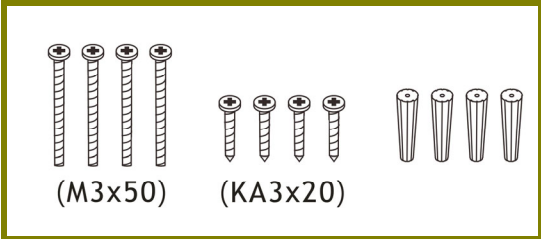

Fixings and Screws

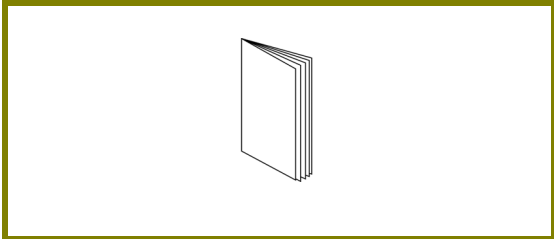

Quick Start Guide

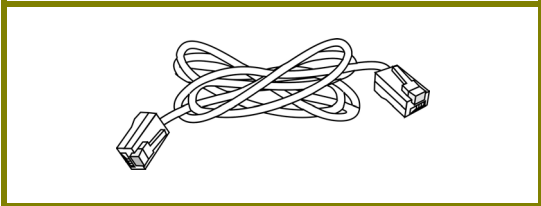

RJ-45 Cable (Ethernet)

2. Panel Explanation

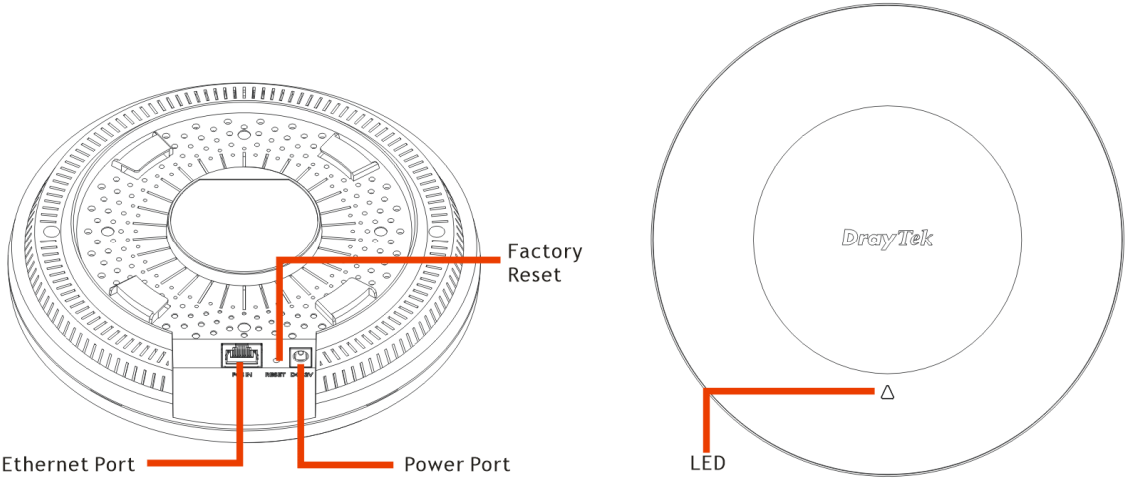

| LED | Status | Explanation |
|------------|----------|--|
| Orange LED | On | The system is in boot-loader mode. |
| | Blinking | The system is in TFTP mode. |
| Blue LED | Blinking | The system is in AP mode and work normally. |
| Red LED | Blinking | System error. When the Red LED blinks twice and then pauses for one second repeatedly, it indicates that the Internet connection is disconnected. |
| Off | Off | VigorAP is turned off or not functioning. |

| Interface | Explanation |
|---------------|--|
| Ethernet Port | Connects to LAN or router. Supports PoE power & Gigabit (2.5G). |

| | |
|--------------------|--------------------------------|
| Power Jack (DC IN) | Connecter for a power adapter. |
|--------------------|--------------------------------|

| Hole | Explanation |
|---------------|--|
| Factory Reset | Restores the unit back to factory default settings. To use, insert a small item such as an unbent paperclip into the hole. You will feel the button inside depress gently. Hold it for 5 seconds. The VigorAP will restart with the factory default configuration and the LED will blink blue. |

3. Installation

VigorAP can be installed under certain locations: wooden ceiling, plasterboard ceilings, and wall.

3.1 Ceiling-mount Installation (from A to C)

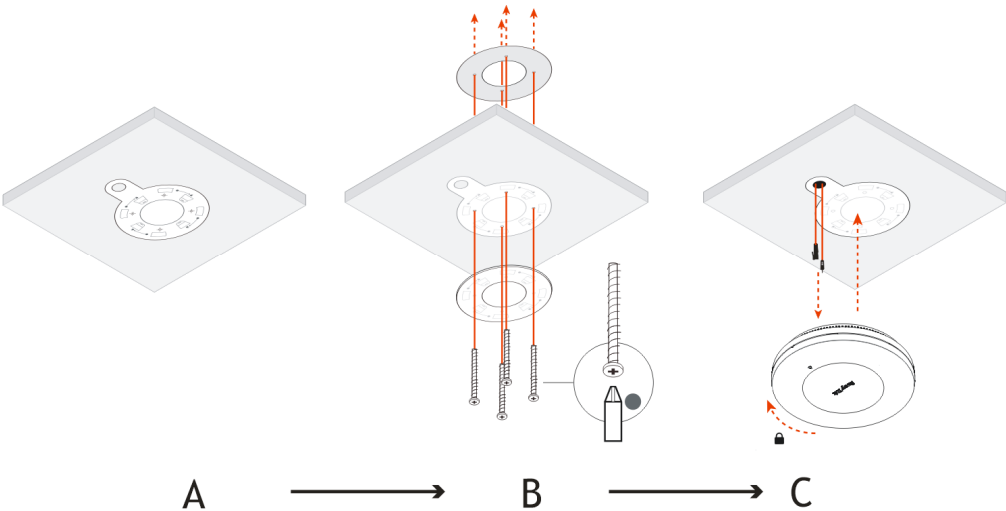

3.2 Wall-mount Installation (from A to C)

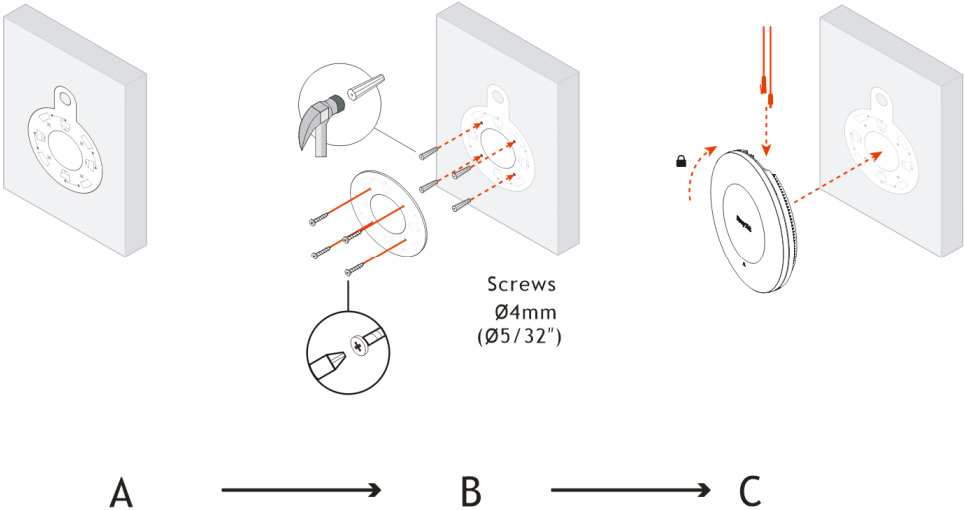

4. Connection and Configuration

4.1 Notifications for Hardware Connection

- Connect VigorAP to Vigor router (via LAN port) with Ethernet cable.

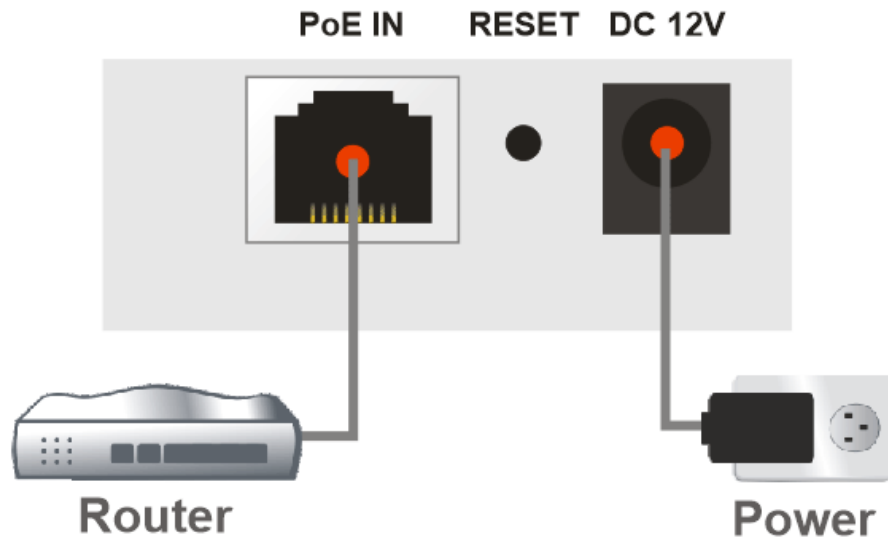

- Connect VigorAP to the PoE switch (via LAN port) with an Ethernet cable for getting the power from the switch directly. While connecting with a PoE switch, the power adapter is not necessary but optional.

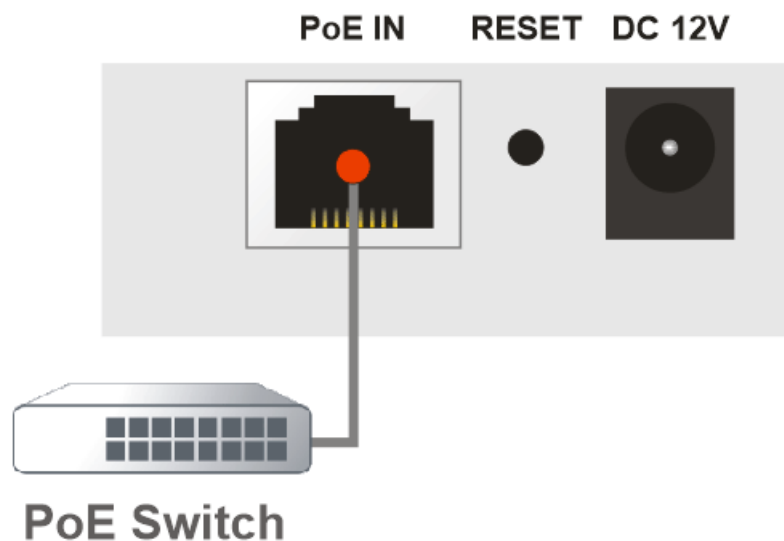

4.2 Web Configurations

There are **two methods** to configure VigorAP.

Method 1:

1. Make sure your PC connects to the modem correctly.
2. Open a web browser on your PC and type **http://192.168.1.2**. A pop-up window will open to ask for username and password. Please enter "admin/admin" as the Username/Password and click **Login**.

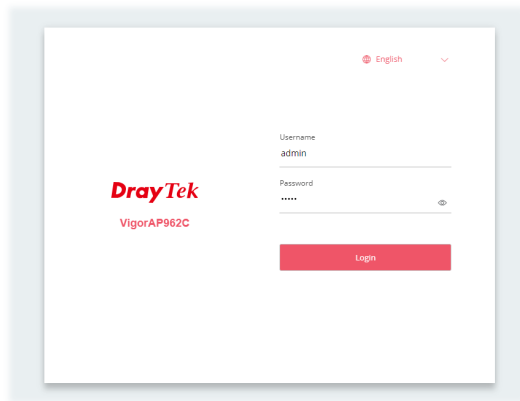

Note

You may either simply set up your computer to get IP dynamically from the router or set up the IP address of the computer to be in the same subnet as **the IP address of VigorAP 962C**.

- If there is no DHCP server on the network, then VigorAP 962C will have an IP address of 192.168.1.2.
 - If there is DHCP available on the network, then VigorAP 962C will receive its IP address via the DHCP server.
-

3. Next, the page will appear to guide you change the login password.

You **MUST** change the login password before accessing the web user interface. Please set a new password for network security.

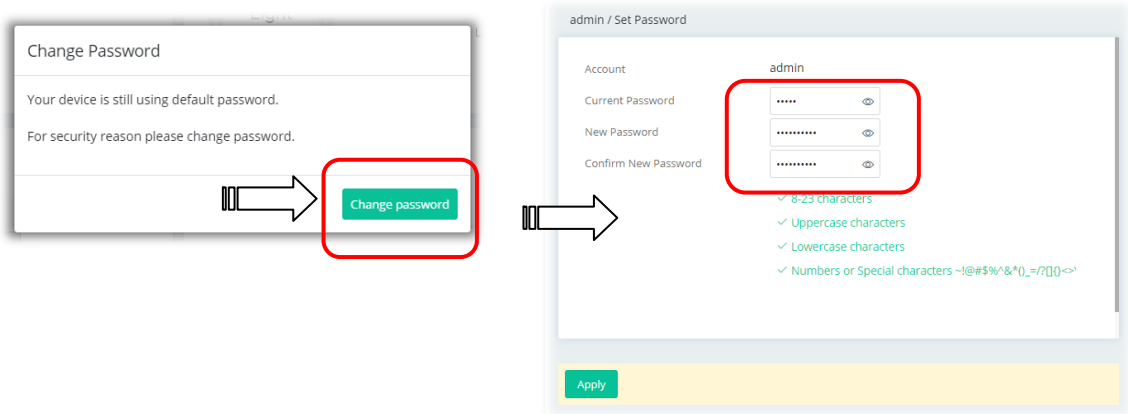

4. After clicking **Apply**, the Main Screen will pop up. When the homepage appears, view the configuration and modify the settings if you want.

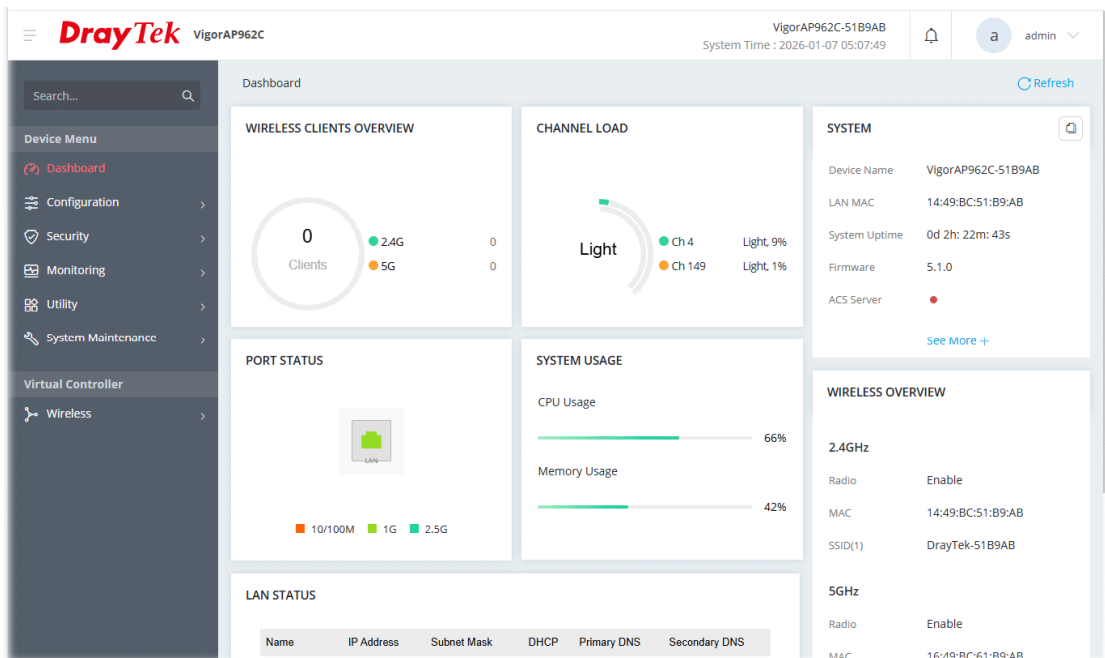

Method 2:

1. Use a mobile phone to scan the QR code named with **DrayTek Wireless App** to download DrayTek Wireless APP.



2. After opening the DrayTek website, use the scroll bar to locate the Wireless APP.



3. Based on the mobile phone type (Android or iOS) you have, select the one you need to download the APP. Then, run the APP.
4. From the home page, click the **Connect** icon to access the **Connect** page. Next, press the QR code icon next to Scan QR Code on your phone screen to open the camera.

Scan the QR code named with **Connect SSID** to access the web user interface (configuration wizard) of VigorAP 962C. (For iOS users, the SSID and the password will be shown first. Simply click the **Connect** button to access the web user interface of VigorAP.)

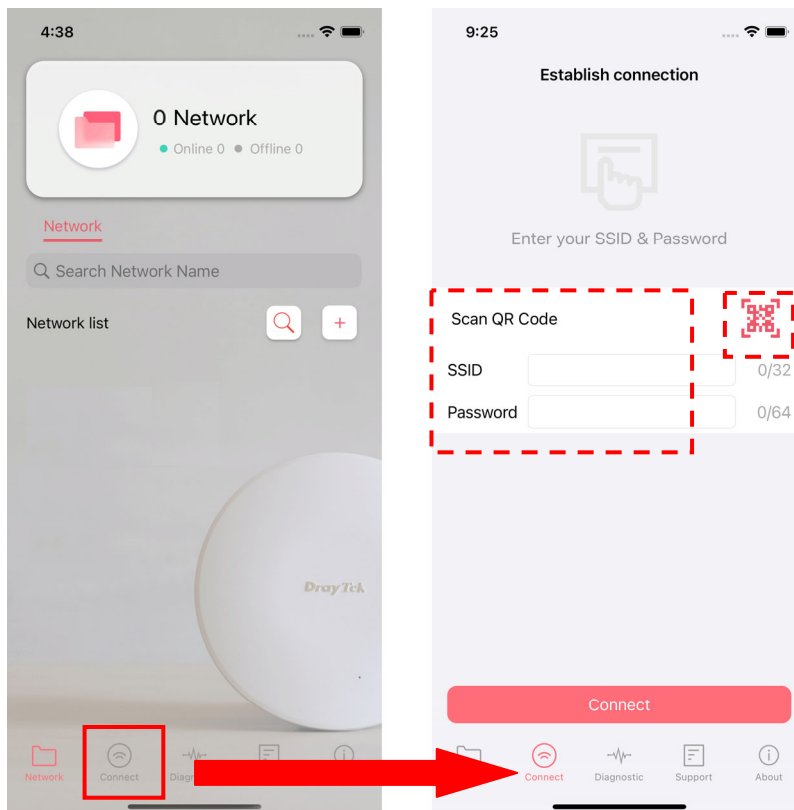

5. Customer Service

If the device cannot work correctly after trying many efforts, please contact your dealer/DrayTek for further help right away. For any questions, please feel free to send e-mail to "support@draytek.com".

Be a Registered Owner

Web registration is preferred. You can register your Vigor router via <https://myvigor.draytek.com>.

Firmware & Tools Updates

Due to the continuous evolution of DrayTek technology, all routers will be regularly upgraded. Please consult the DrayTek web site for more information on newest firmware, tools and documents.

<https://www.draytek.com>

GPL Notice

This DrayTek product uses software partially or completely licensed under the terms of the GNU GENERAL PUBLIC LICENSE. The author of the software does not provide any warranty. A Limited Warranty is offered on DrayTek products. This Limited Warranty does not cover any software applications or programs.

To download source codes please visit:

<http://gplsource.draytek.com>

GNU GENERAL PUBLIC LICENSE:

<https://gnu.org/licenses/gpl-2.0>

Version 2, June 1991

For any question, please feel free to contact DrayTek technical support at support@draytek.com for further information.