



EMI TEST REPORT

FOR

802.11ac Ceiling-mount Access Point

MODEL : VigorAP 912C

REPORT NUMBER : 4788947466A-US-E0-V0

ISSUE DATE : Sep. 27, 2019

Prepared for

Draytek Corporation

No.26, Fu Shing Rd., HuKou County, Hsinchu Industrial Park,HsinChu,303,Taiwan

Tel: + 886-35972727

Prepared by

Underwriters Laboratories Taiwan Co., Ltd.

**Building B and Building E, No. 372-7, Sec. 4, Zhongxing Rd., Zhudong Township,
Hsinchu County, Taiwan**

Tel: +886.2.2896.7790

Fax: +886.3.583.7948

Website: www.ul.com



The results reported herein have been performed in accordance with the laboratory's terms of accreditation. This report shall not be reproduced except in full without the written approval of the Laboratory. The results in this report are responsible of the test sample(s) provided by the client only and are not to be used to indicate applicability to other similar products.

Page 1 of 31

Revision History

Rev.	Issue Date	Revisions	Revised By
--	Sep. 27, 2019	Initial Issue	Cindy Hisn

Summary of Test Results			
Standard	Test Item	Limit	Result
FCC Part 15 Subpart B Class B ANSI C63.4:2014	Conducted emission	Class B	PASS
	Radiated emission (Below 1 GHz)	Class B	PASS
	Radiated emission (Above 1 GHz)	Class B	PASS

TABLE OF CONTENTS

1. ATTESTATION OF TEST RESULTS	5
2. TEST METHODOLOGY	6
3. FACILITIES AND ACCREDITATION	6
4. CALIBRATION AND UNCERTAINTY	7
4.1. Measuring Instrument Calibration	7
4.2. Measurement Uncertainty	7
5. EQUIPMENT UNDER TEST	8
5.1. Description of EUT	8
5.2. Test Mode	8
5.3. EUT Operation Test Setup	9
5.4. Accessory	9
5.5. Block diagram showing the configuration of system tested	10
5.6. Description of support units	11
5.7. Measuring Instrument List	12
6. EMISSION TEST	13
6.1. Conducted Disturbance Measurement	13
6.1.1. Limits of conducted disturbance voltage and common mode disturbance	13
6.1.2. Test Procedure	13
6.1.3. Test Setup	14
6.1.4. Test Result	15
6.2. Radiated Disturbance Measurement (below 1G)	17
6.2.1. Limits of radiated disturbance measurement	17
6.2.2. Test Procedure	17
6.2.3. Test Setup	18
6.2.4. Test Result	19
6.3. Radiated Disturbance Measurement (above 1G)	21
6.3.1. Limits of radiated disturbance measurement	21
6.3.2. Test Procedure	22
6.3.3. Test Setup	22
6.3.4. Test Result	24
Appendix I: Photographs of Test Configuration	28
Appendix II: Photographs of the EUT	31

1. ATTESTATION OF TEST RESULTS

COMPANY NAME: Draytek Corporation
No.26, Fu Shing Rd., HuKou County, Hsinchu Industrial
Park,HsinChu,303,Taiwan

EUT DESCRIPTION: 802.11ac Ceiling-mount Access Point

MODEL: VigorAP 912C

DATE TESTED: May. 13, 2019 ~ Aug. 22, 2019

APPLICABLE STANDARDS	
STANDARDS	TEST RESULTS
FCC Part 15 Subpart B: Class B ANSI C63.4:2014	PASS

Underwriters Laboratories Taiwan Co., Ltd. tested the above equipment in accordance with the requirements set forth in the above standards. All indications of Pass/Fail in this report are opinions expressed by Underwriters Laboratories Taiwan Co., Ltd. based on interpretations and/or observations of test results. The test results show that the equipment tested is capable of demonstrating compliance with the requirements as documented in this report.

Note: The results documented in this report apply only to the tested sample, under the conditions and modes of operation as described herein. This document may not be altered or revised in any way unless done so by Underwriters Laboratories Taiwan Co., Ltd. and all revisions are duly noted in the revisions section. Any alteration of this document not carried out by Underwriters Laboratories Taiwan Co., Ltd. will constitute fraud and shall nullify the document. This report must not be used by the client to claim product certification, approval, or endorsement by NVLAP, NIST, any agency of the Federal Government, or any agency of any government.

Prepared By:

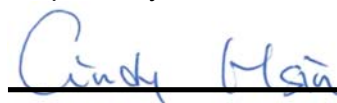

Cindy Hisn
Project Handler

Date : Sep. 27, 2019

Approved and Authorized By:



Roy Chen
Operations Manager

Date : Sep. 27, 2019

2. TEST METHODOLOGY

All tests were performed in accordance with the procedures documented FCC Part 15 Subpart B and ANSI C63.4

3. FACILITIES AND ACCREDITATION

Test Location	Underwriters Laboratories Taiwan Co., Ltd.,
Address	Building B and Building E, No. 372-7, Sec. 4, Zhongxing Rd., Zhudong Township, Hsinchu County, Taiwan
Description	All measurement facilities use to collect the measurement data are located at Building B and Building E, No. 372-7, Sec. 4, Zhongxing Rd., Zhudong Township, Hsinchu County, Taiwan

4. CALIBRATION AND UNCERTAINTY

4.1. Measuring Instrument Calibration

The measuring equipment utilized to perform the tests documented in this report has been calibrated in accordance with the manufacturer's recommendations, and is traceable to recognized national standards.

4.2. Measurement Uncertainty

Where relevant, the following measurement uncertainty levels have been estimated for tests performed on the apparatus:

The following uncertainties have been calculated to provide a confidence level of 95 % using a coverage factor $k=2$.

Test Item	Measurement Frequency Range	K	U(dB)
Conducted disturbance at mains terminals ports	0.15MHz ~ 30MHz	2	1.7
966-1 Test Site			
Radiated disturbance below 1 GHz	30MHz ~ 1000MHz	2	5.2
Radiated disturbance above 1 GHz	1000MHz ~ 6000MHz	2	4.5
	6000-18000MHz	2	4.9
	18000-40000MHz	2	4.6

5. EQUIPMENT UNDER TEST

5.1. Description of EUT

EUT Name:	802.11ac Ceiling-mount Access Point
Model:	VigorAP 912C
Power Rating:	AC 100V – 240V, 50/60Hz
Highest Frequency within EUT:	5850MHz
Condition of EUT:	Identical Prototype
Date Of Receipt Of Sample:	May 10, 2019

5.2. Test Mode

The pre-test mode:

Mode	Description	Conducted Emission	Radiated Emission
Mode 1	Link WAN + WiFi with Adapter Mode + horizontal	v	v
Mode 2	Link WAN + WiFi with POE Mode + horizontal	–	v
Mode 3	Link WAN + WiFi with Adapter Mode + vertical	–	v

After pre-testing, the final test mode was displayed as below table.

Test Items		Test Mode
Emission	Conducted Emission	Mode 1
	Radiated Emission	Mode 2

5.3. EUT Operation Test Setup

Mode 1:

- a. Set EUT to horizontal polarization.
- b. Connect the EUT to Notebook 1 via RJ-45 cable.
- c. Connect the EUT to Notebook 2 via WiFi 2.4G.
- d. Connect the EUT to Notebook 3 via WiFi 5G.
- e. Run "Ping.exe" on Notebook 1 to confirm the WAN connection status.
- f. Run "Ping.exe" on Notebook 2 and 3 to confirm the WiFi connection status.

Mode 2:

- a. Set EUT to horizontal polarization.
- b. Connect the EUT adapter to PoE via RJ-45 cable.
- c. Connect PoE adapter to Notebook 1 via RJ-45 cable.
- d. Connect the EUT to Notebook 2 via WiFi 2.4G.
- e. Connect the EUT to Notebook 3 via WiFi 5G.
- f. Run "Ping.exe" on Notebook 1 to confirm the WAN connection status.
- g. Run "Ping.exe" on Notebook 2 and 3 to confirm the WiFi connection status.

5.4. Accessory

Item	Accessory	Brand Name	Model Name	Note
A	Adapter	DEE VAN ENTERPRISE CO., LTD	DSA-12PF09-12 FUS 120100	N/A
1	Power wire	DEE VAN ENTERPRISE CO., LTD	DSA-12PFU-12 FEU 120100	Length: 1.5m Non-shielded
2	RJ-45 cable	-	-	Length: 1.8m Non-shielded
-	Ceiling mount bracket	-	-	-
-	Fixing and screws(for ceiling mounting)	-	-	-
-	Screw set(wall mounting)	-	-	-
-	T-Rail mounting kits(Used for suspended ceiling)	-	-	-

5.5. Block diagram showing the configuration of system tested

Mode 1

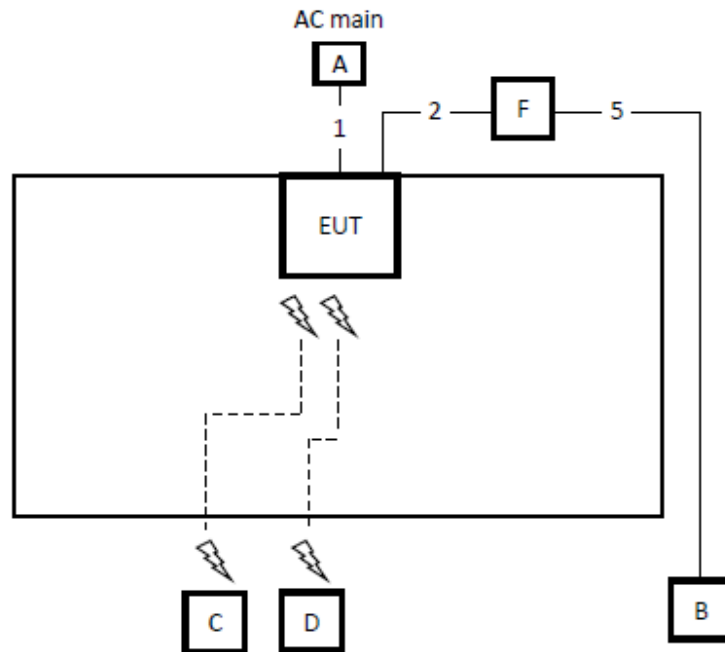

Mode 2

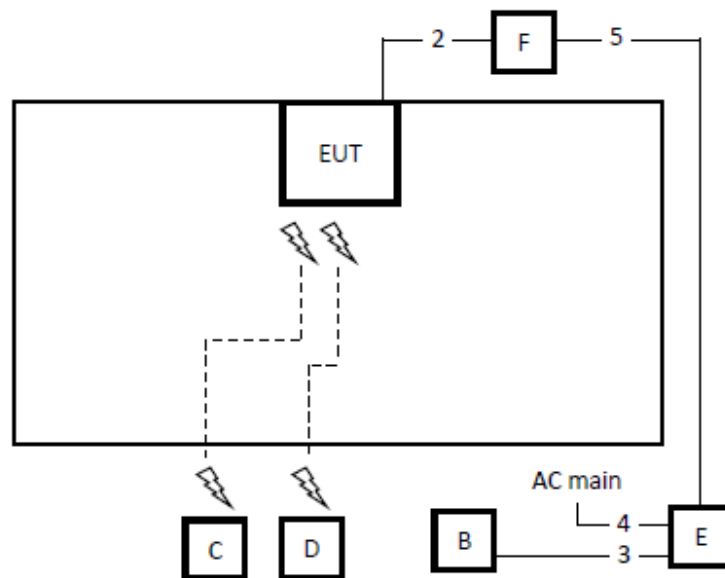

5.6. Description of support units

The EUT has been tested as an independent unit together with other necessary accessories or support units. The following support units or accessories were used to form a representative test configuration during the tests.

Item	Equipment	Mfr/Brand	Model/Type No.	Series No.	FCC ID	Note
B	Notebook 1	DELL	Latitude E5470	5M2MWF2	N/A	N/A
C	Notebook 2	DELL	Latitude E5470	CXSKWF2	N/A	N/A
D	Notebook 3	DELL	Latitude E5470	3JFKWF2	N/A	N/A
E	PoE adapter	Bullet PoE	BPI100-GH	1804240137	N/A	N/A
F	Connector	N/A	N/A	N/A	N/A	N/A

Item	Connection	Shielded Type	Length	Note
3	RJ-45 cable	No	1 m	N/A
4	Power cable	No	1.5 m	N/A
5	RJ-45 cable	No	10 m	N/A

Note: (1) for detachable type I/O cable should be specified the length in m in "Length" column.

5.7. Measuring Instrument List

Instrument						
Used	Equipment	Manufacturer	Model No.	Serial No.	Last Cal.	Expired date
Conducted Disturbance						
<input checked="" type="checkbox"/>	EMI Test Receiver	Rohde & Schwarz	ESR7	101753	2018/11/14	2019/11/13
<input checked="" type="checkbox"/>	Two-Line V-Network	Rohde & Schwarz	ENV216	102136	2018/8/5	2019/8/4
<input checked="" type="checkbox"/>	Impuls-Begrenzer Pulse Limiter	Rohde & Schwarz	ESH3-Z2	102219-Qt	2018/8/2	2019/8/1
<input checked="" type="checkbox"/>	Measurement Software	Farad	EZ-EMC Ver: EMEC-3A1	N/A	N/A	N/A
Radiated Disturbance						
966-1						
<input checked="" type="checkbox"/>	EMI Test Receiver	Rohde & Schwarz	ESR7	101755	2018/11/27	2019/11/26
<input checked="" type="checkbox"/>	Trilog-Broadband Antenna with 5dB Attenuator	SCHWARZ BECK	VULB 9168 & N-6-05	9168-773 & AT-N0539	2019/1/14	2020/1/13
<input checked="" type="checkbox"/>	Double Ridged Guide Horn Antenna	SCHWARZ BECK	BBHA 9120 D	1686	2019/1/16	2020/1/15
<input checked="" type="checkbox"/>	Broadband Horn Antenna	SCHWARZ BECK	BBHA 9170	759	2018/11/13	2019/11/12
<input checked="" type="checkbox"/>	Preamplifier	EMC Instrument	EMC330E	980404	2019/1/8	2020/1/7
<input checked="" type="checkbox"/>	Preamplifier	EMC Instrument	EMC051835BE	980407	2019/1/8	2020/1/7
<input checked="" type="checkbox"/>	Preamplifier	EMC Instrument	EMC184045SE	980408	2019/3/21	2020/3/19
<input checked="" type="checkbox"/>	Measurement Software	Farad	EZ-EMC Ver: EMEC-3A1	N/A	N/A	N/A

6. EMISSION TEST

6.1. Conducted Disturbance Measurement

6.1.1. Limits of conducted disturbance voltage and common mode disturbance

FREQUENCY (MHz)	□ Class A (dB μ V)		☒ Class B (dB μ V)	
	Quasi-peak	Average	Quasi-peak	Average
0.15 -0.5	79.00	66.00	66 - 56 *	56 - 46 *
0.50 -5.0	73.00	60.00	56.00	46.00
5.0 -30.0	73.00	60.00	60.00	50.00

Note:

- (1) The tighter limit applies at the band edges.
- (2) The limit of " * " marked band means the limitation decreases linearly with the logarithm of the frequency in the range.
- (3) The test result calculated as following:
 Measurement Value = Reading Level + Correct Factor
 Correct Factor = Insertion Loss + Cable Loss + Attenuator Factor(if use)
 Margin Level = Measurement Value - Limit Value

The following table is the setting of the receiver

Receiver Parameters	Setting
Attenuation	10 dB
Start Frequency	0.15 MHz
Stop Frequency	30 MHz
IF Bandwidth	9 kHz

6.1.2. Test Procedure

- a. The EUT was placed 0.8 meters from the horizontal ground plane with EUT being connected to the power mains through a line impedance stabilization network (LISN). All other support equipments powered from additional LISN(s). The LISN provide 50 Ohm/ 50uH of coupling impedance for the measuring instrument.
- b. Interconnecting cables that hang closer than 40 cm to the ground plane shall be folded back and forth in the center forming a bundle 30 to 40 cm long.
- c. I/O cables that are not connected to a peripheral shall be bundled in the center. The end of the cable may be terminated, if required, using the correct terminating impedance. The overall length shall at least 1 m.
- d. LISN at least 80 cm from nearest part of EUT chassis.
- e. For the actual test configuration, please refer to the related Item: EUT Test Photos.

6.1.3. Test Setup

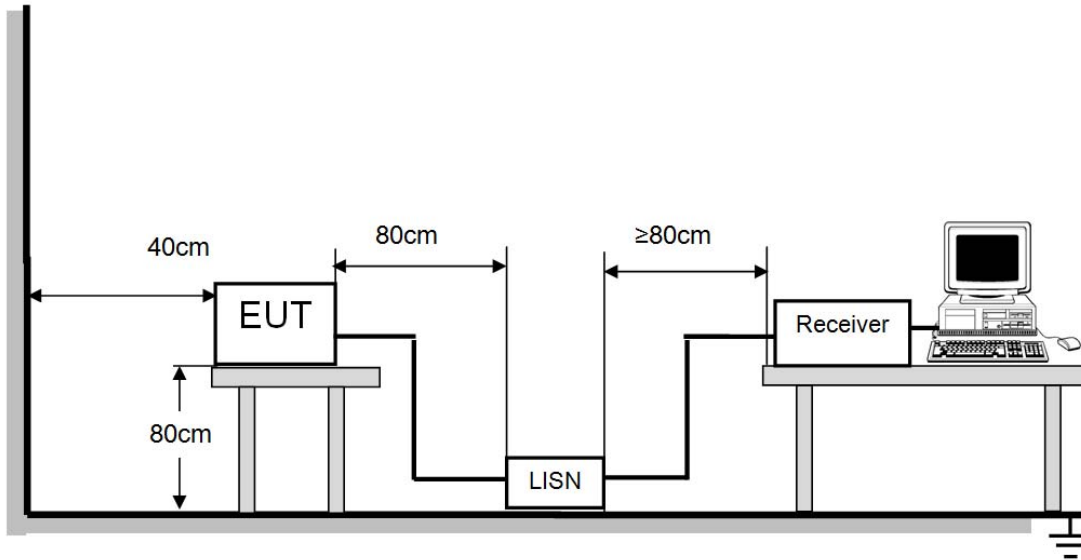

For the actual test configuration, please refer to Appendix I: Photographs of the Test Configuration.

6.1.4. Test Result

Test Mode:	Mode 1	Temperature:	23°C
Test Voltage:	AC 120V/60Hz	Humidity:	60%
Tested By:	Edison Lin	Test Date:	May. 14, 2019

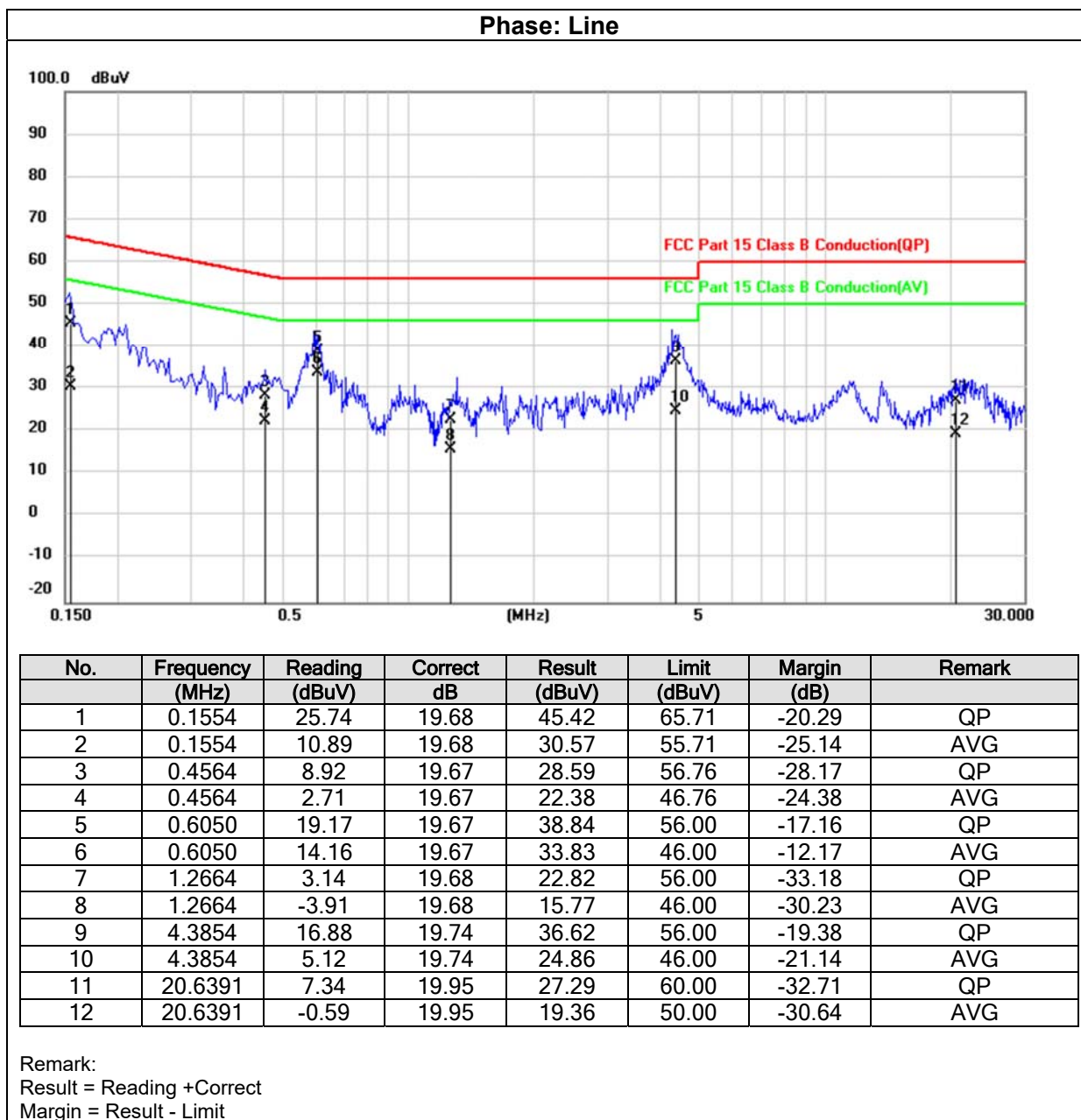

Test Mode:	Mode 1	Temperature:	23°C
Test Voltage:	AC 120V/60Hz	Humidity:	60%
Tested By:	Edison Lin	Test Date:	May. 14, 2019

Phase: Neutral

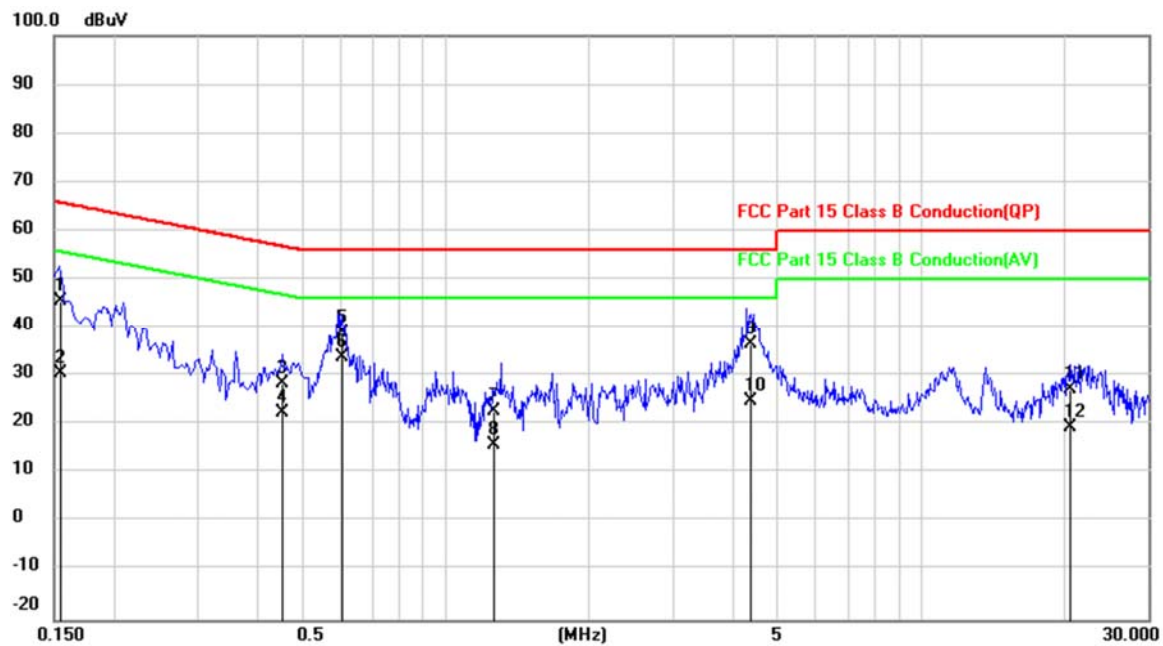

No.	Frequency (MHz)	Reading (dBuV)	Correct dB	Result (dBuV)	Limit (dBuV)	Margin (dB)	Remark
1	0.1554	25.74	19.68	45.42	65.71	-20.29	QP
2	0.1554	10.89	19.68	30.57	55.71	-25.14	AVG
3	0.4564	8.92	19.67	28.59	56.76	-28.17	QP
4	0.4564	2.71	19.67	22.38	46.76	-24.38	AVG
5	0.6050	19.17	19.67	38.84	56.00	-17.16	QP
6	0.6050	14.16	19.67	33.83	46.00	-12.17	AVG
7	1.2664	3.14	19.68	22.82	56.00	-33.18	QP
8	1.2664	-3.91	19.68	15.77	46.00	-30.23	AVG
9	4.3854	16.88	19.74	36.62	56.00	-19.38	QP
10	4.3854	5.12	19.74	24.86	46.00	-21.14	AVG
11	20.6391	7.34	19.95	27.29	60.00	-32.71	QP
12	20.6391	-0.59	19.95	19.36	50.00	-30.64	AVG

Remark:
 Result = Reading +Correct
 Margin = Result - Limit

6.2. Radiated Disturbance Measurement (below 1G)

6.2.1. Limits of radiated disturbance measurement

FREQUENCY (MHz)	<input checked="" type="checkbox"/> Class B
	<input checked="" type="checkbox"/> At 3m
	(microvolts/meter)
30 – 88	100
88 – 216	150
216 – 960	200
960 – 1000	500

NOTE:

- (1) The tighter limit applies at the band edges.
- (2) Emission level (dB μ V/m)=20*log Emission level (uV/m).
- (3) The test result calculated as following:
Measurement Value = Reading Level + Correct Factor,
Correct Factor = Antenna Factor + Cable Loss - Amplifier Gain(if use),
Margin Level = Measurement Value - Limit Value.

6.2.2. Test Procedure

- a. The EUT was placed on the top of a rotating table 0.8 meters above the ground at a 3 meter chamber. The table was rotated 360 degrees to determine the position of the highest radiation.
- b. The height of the equipment or of the substitution antenna shall be 0.8 m; the height of the test antenna shall vary between 1 m to 4 m. Both horizontal and vertical polarizations of the antenna are set to make the measurement.
- c. The initial step in collecting radiated emission data is a spectrum analyzer peak detector mode pre-scanning the measurement frequency range. Significant peaks are then marked and then Quasi Peak detector mode re-measured.
- d. If the Peak Mode measured value compliance with and lower than Quasi Peak Mode Limit, the EUT shall be deemed to meet QP Limits and then no additional QP Mode measurement performed.
- e. For the actual test configuration, please refer to the related Item: EUT Test Photos.

6.2.3. Test Setup

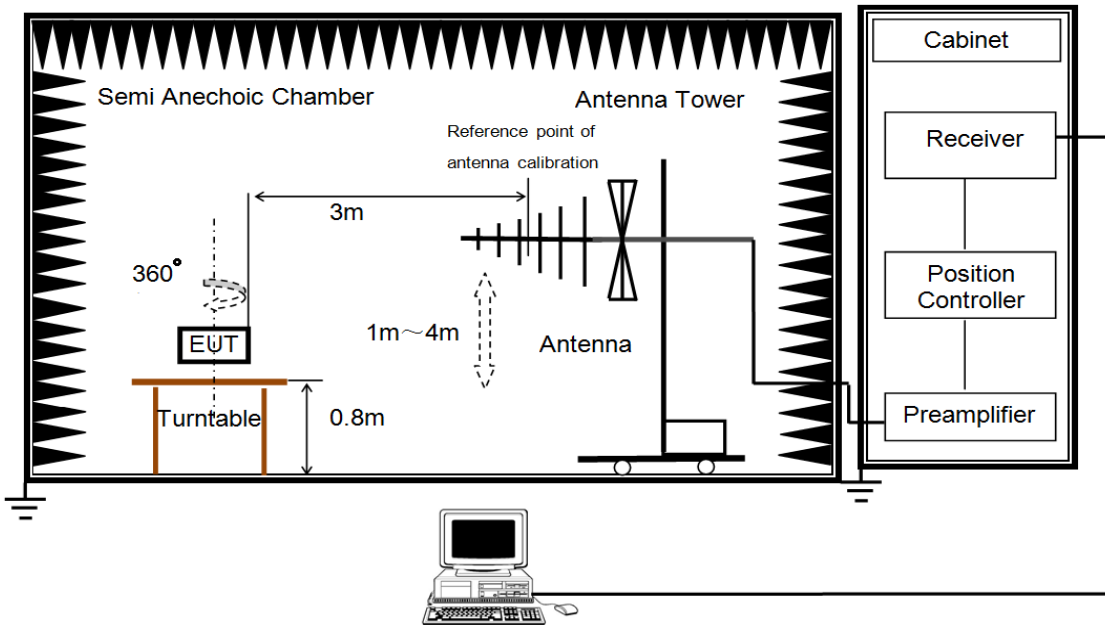

For the actual test configuration, please refer to Appendix I: Photographs of the Test Configuration.

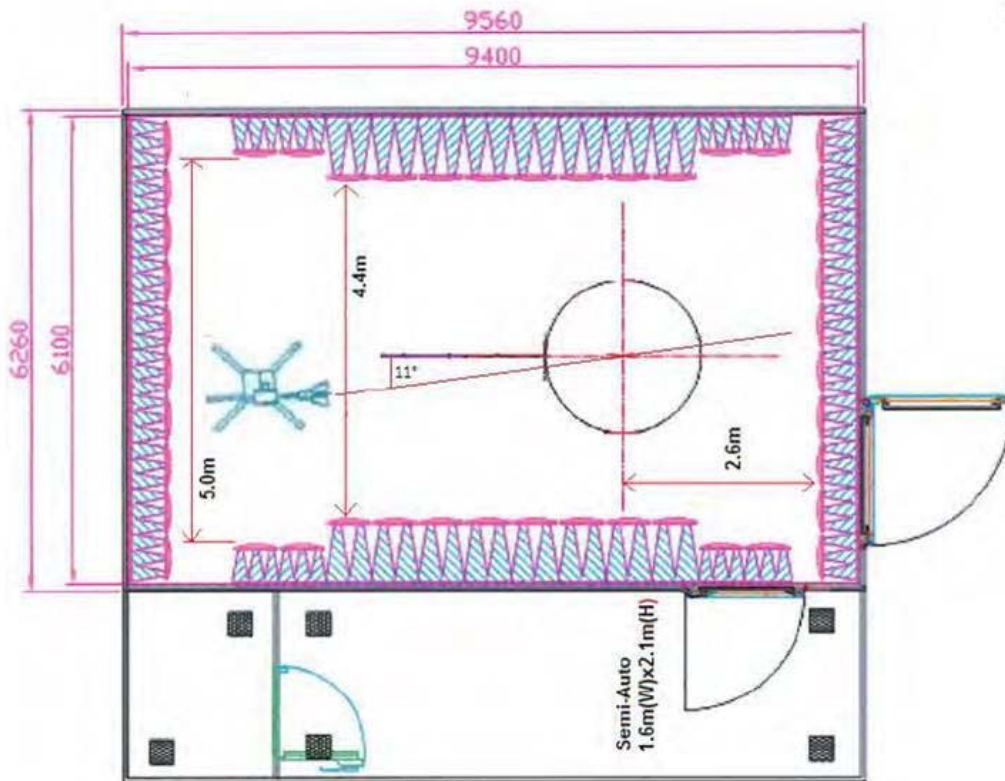

6.2.4. Test Result

Test Mode:	Mode 2	Temperature:	25°C
Test Voltage:	AC 120V/60Hz	Humidity:	52%
Tested By:	Edison Lin	Test Date:	May. 13, 2019

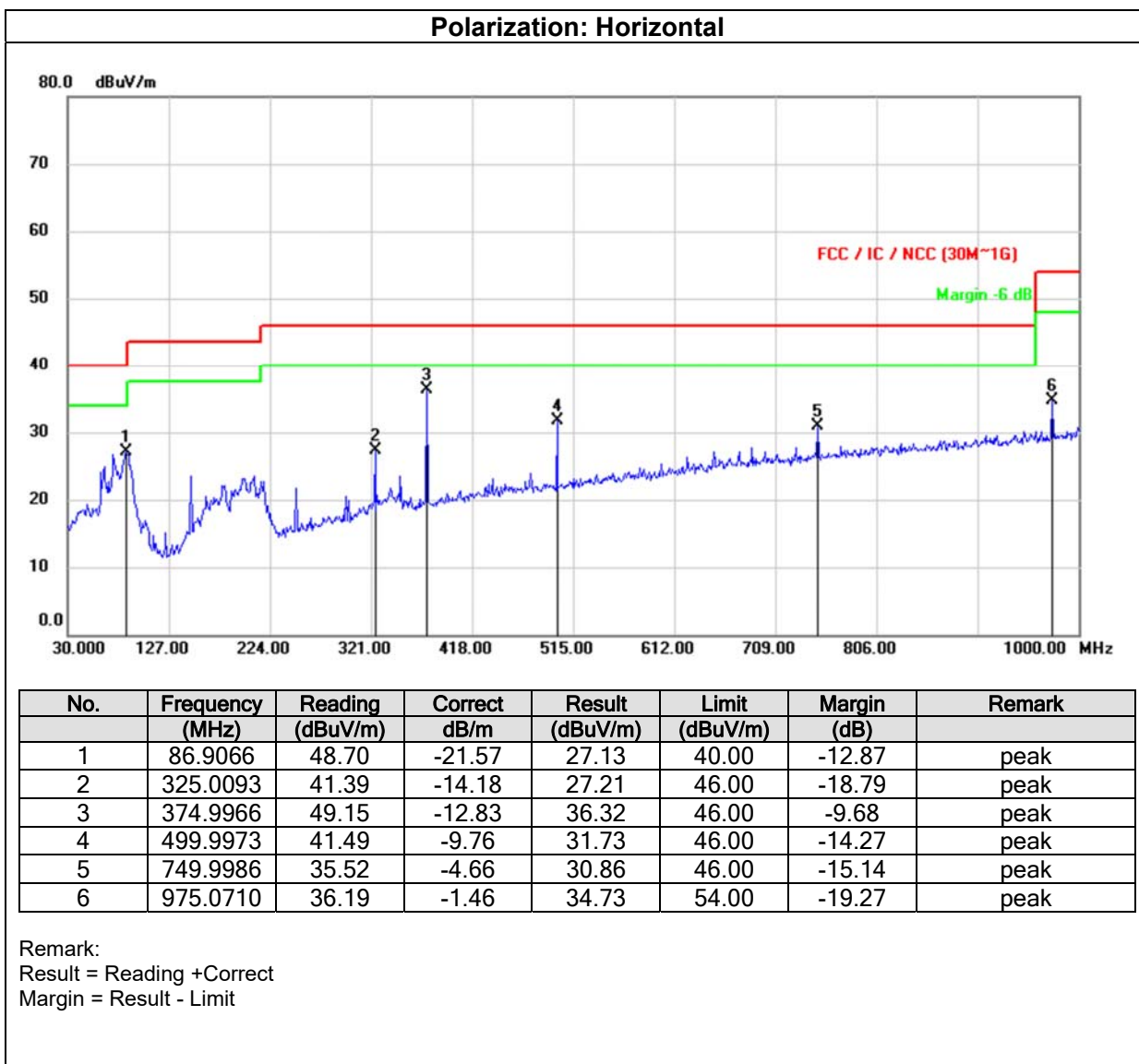

Test Mode:	Mode 2	Temperature:	25°C
Test Voltage:	AC 120V/60Hz	Humidity:	52%
Tested By:	Edison Lin	Test Date:	May. 13, 2019

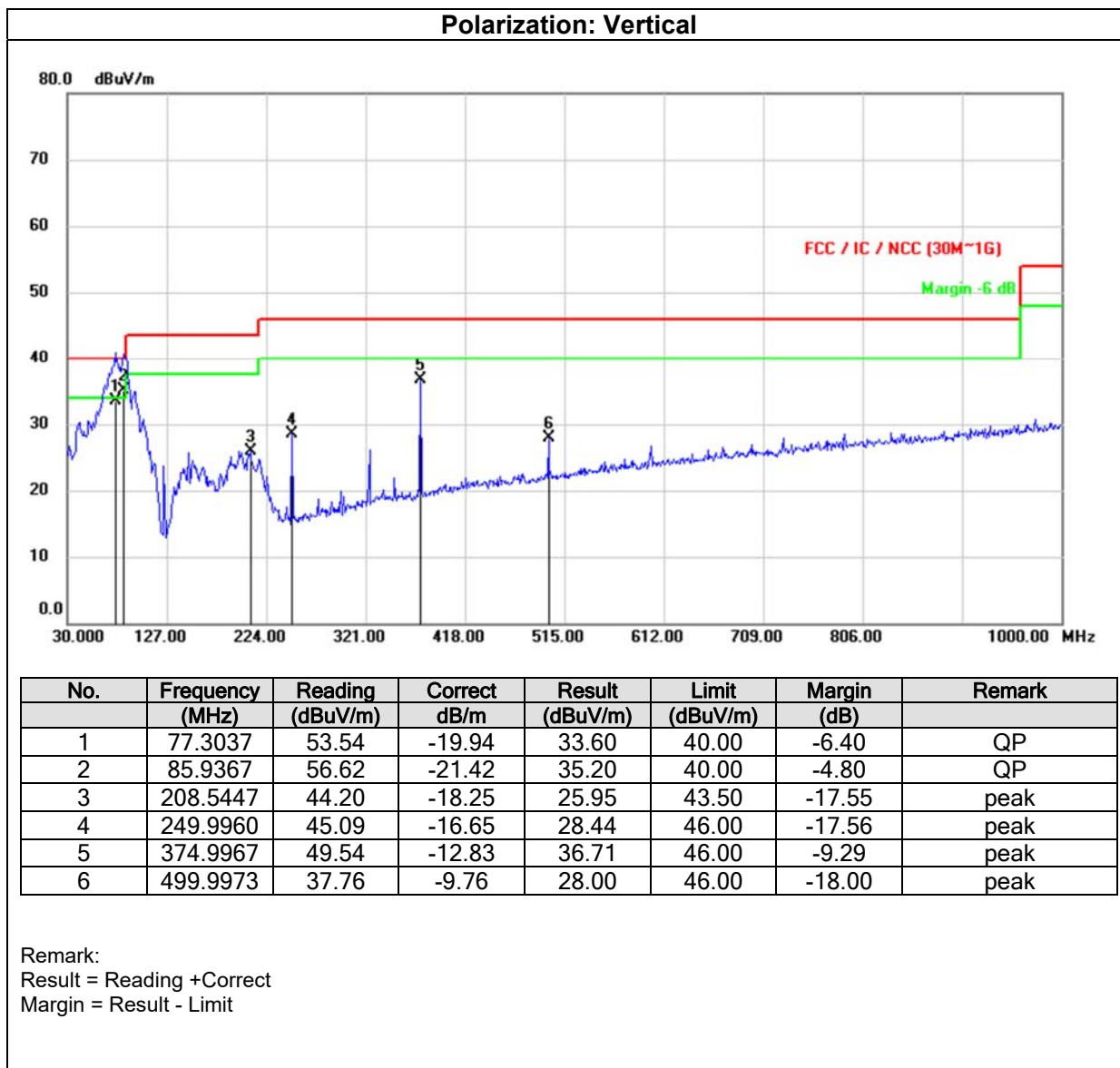

6.3. Radiated Disturbance Measurement (above 1G)

6.3.1. Limits of radiated disturbance measurement

FREQUENCY (MHz)	<input checked="" type="checkbox"/> Class B	
	<input checked="" type="checkbox"/> At 3m	
	Average limit dB(μ V/m)	Peak limit dB(μ V/m)
1000-40000	54	74

NOTE:

- (1) The tighter limit applies at the band edges.
- (2) Emission level (dB μ V/m)=20log Emission level (uV/m).
- (3) If the highest frequency of the internal sources of the EUT is less than 108 MHz, the measurement shall only be made up to 1 GHz. If the highest frequency of the internal sources of the EUT is between 108 MHz and 500 MHz, the measurement shall only be made up to 2 GHz. If the highest frequency of the internal sources of the EUT is between 500 MHz and 1 GHz, measurement shall only be made up to 5GHz. If the highest frequency of the internal sources of the EUT is above 1 GHz, the measurement shall be made up to 5 times the highest frequency or 40 GHz, whichever is less.
- (4) The test result calculated as following:
 Measurement Value = Reading Level + Correct Factor,
 Correct Factor = Antenna Factor + Cable Loss - Amplifier Gain(if use),
 Margin Level = Measurement Value - Limit Value.

6.3.2. Test Procedure

- a. The EUT was placed on the top of a rotating table 0.8 meters above the ground at a 3 meter chamber. The table was rotated 360 degrees to determine the position of the highest radiation.
- b. The height of the equipment or of the substitution antenna shall be 0.8 m; the height of the test antenna shall vary between 1 m to 4 m. Both horizontal and vertical polarizations of the antenna are set to make the measurement.
- c. The initial step in collecting radiated emission data is a spectrum analyzer peak detector mode pre-scanning the measurement frequency range. Significant peaks are then marked and then Average detector mode re-measured.
- d. For the actual test configuration, please refer to the related Item:EUT Test Photos.

6.3.3. Test Setup

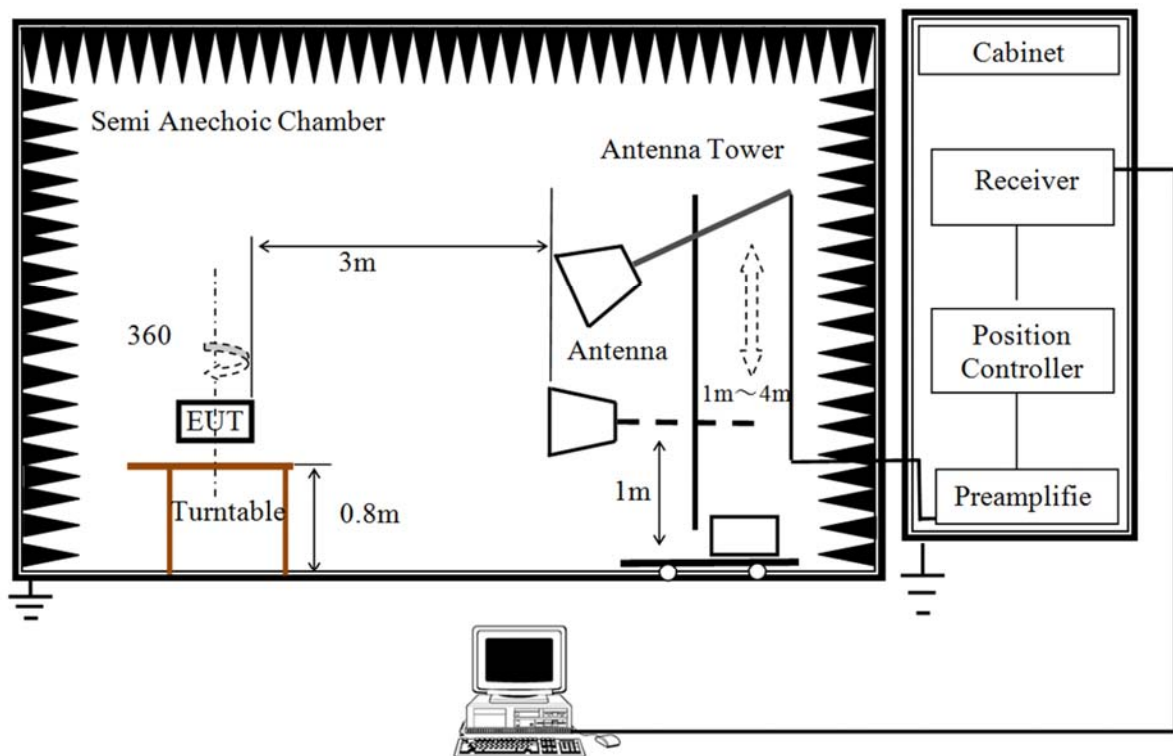

For the actual test configuration, please refer to Appendix I : Photographs of the Test Configuration.

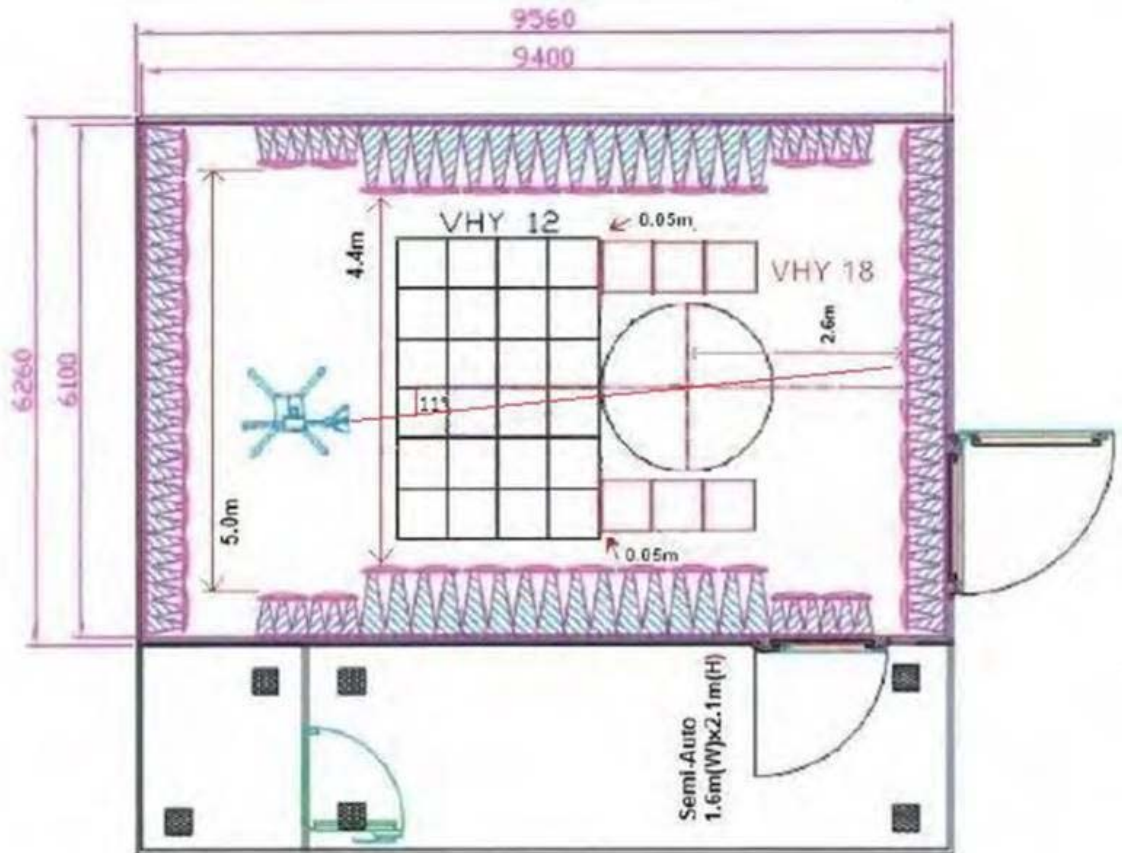

6.3.4. Test Result

Test Mode:	Mode 2	Temperature:	25°C
Test Voltage:	AC 120V/60Hz	Humidity:	52%
Tested By:	Edison Lin	Test Date:	Aug. 22, 2019
Frequency Range	1GHz ~ 18GHz		

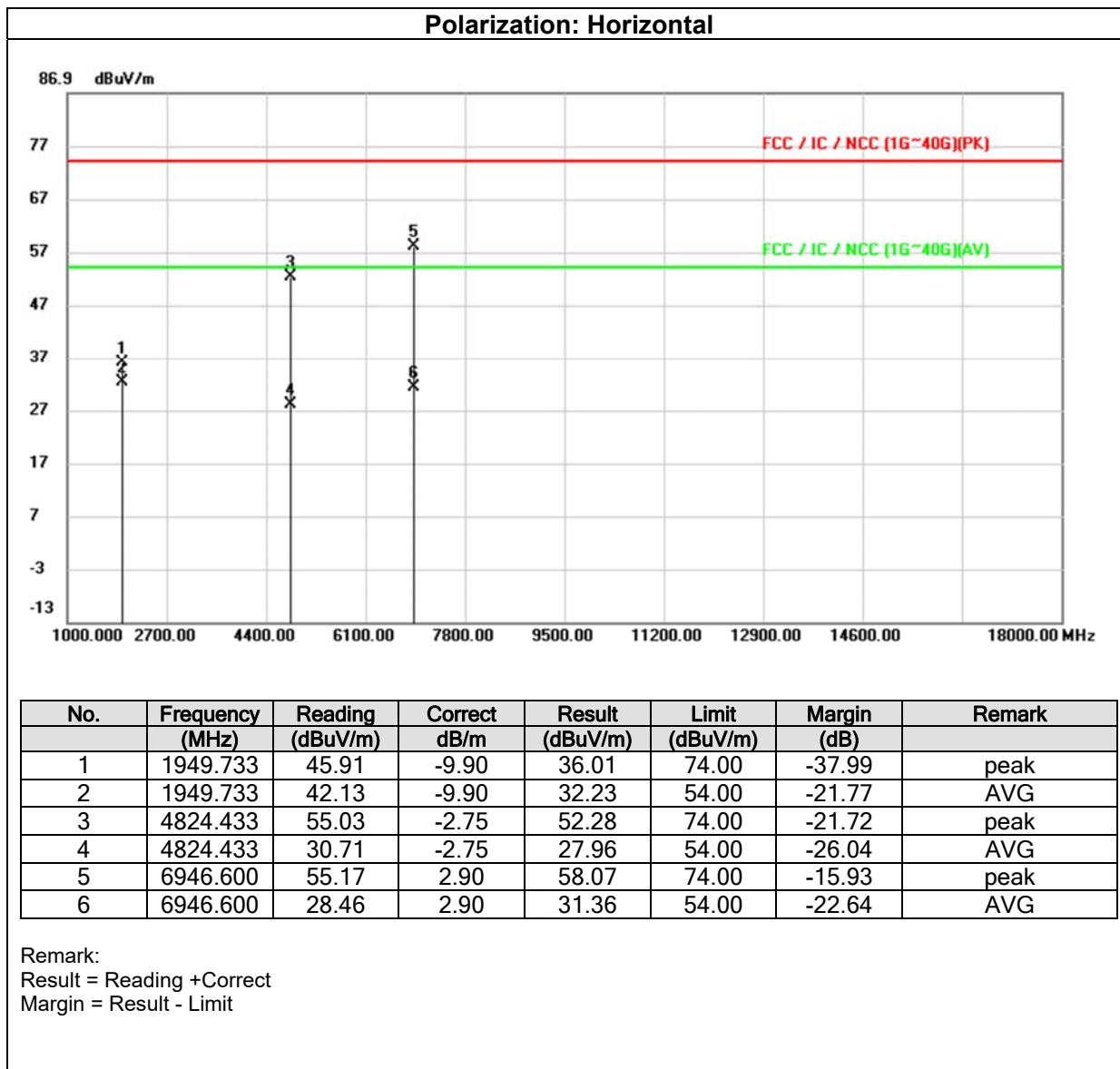

Test Mode:	Mode 2	Temperature:	25°C
Test Voltage:	AC 120V/60Hz	Humidity:	52%
Tested By:	Edison Lin	Test Date:	Aug. 22, 2019
Frequency Range	1GHz ~ 18GHz		

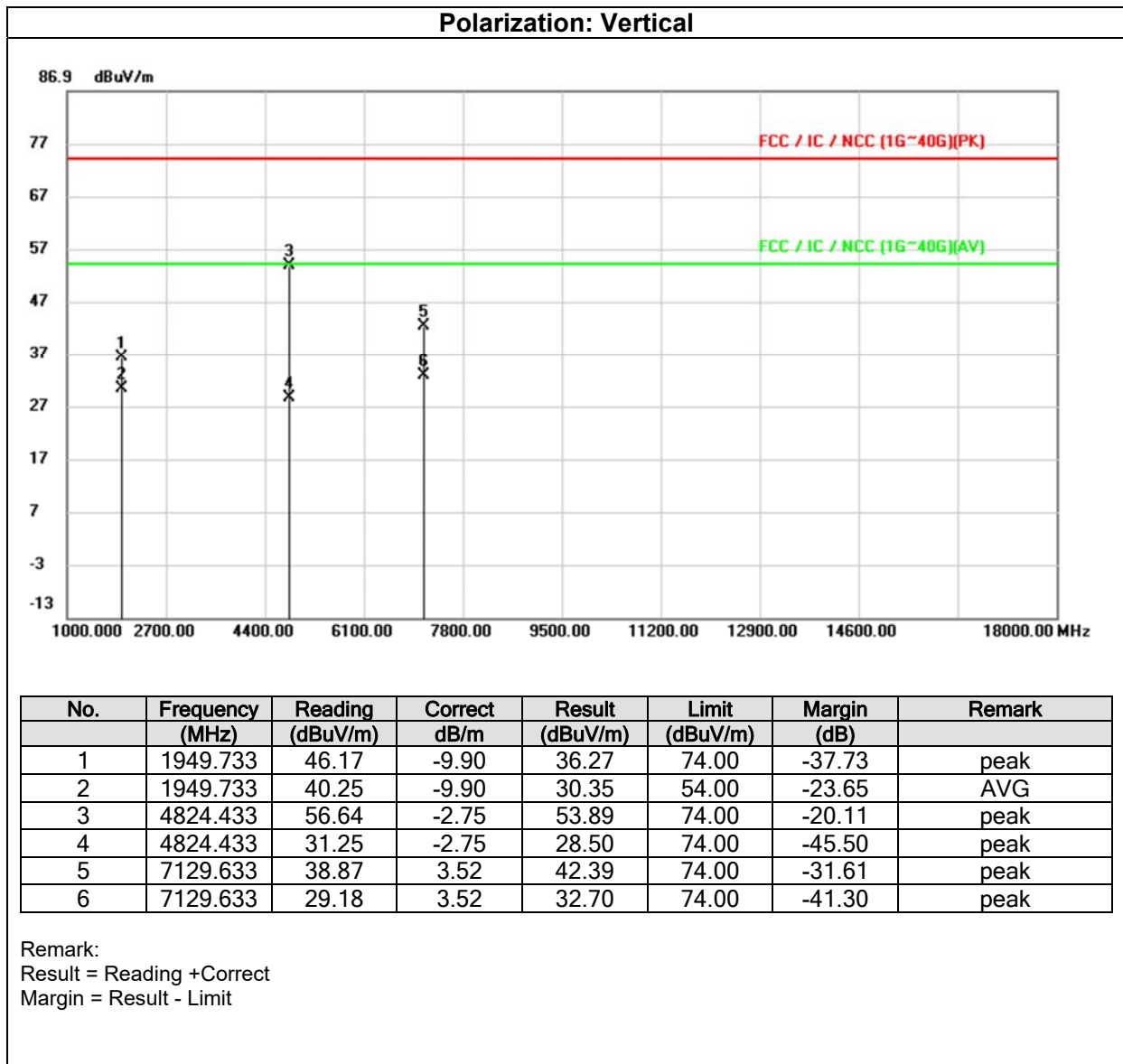

Test Mode:	Mode 2	Temperature:	25°C
Test Voltage:	AC 120V/60Hz	Humidity:	52%
Tested By:	Edison Lin	Test Date:	Aug. 22, 2019
Frequency Range	18GHz ~ 40GHz		

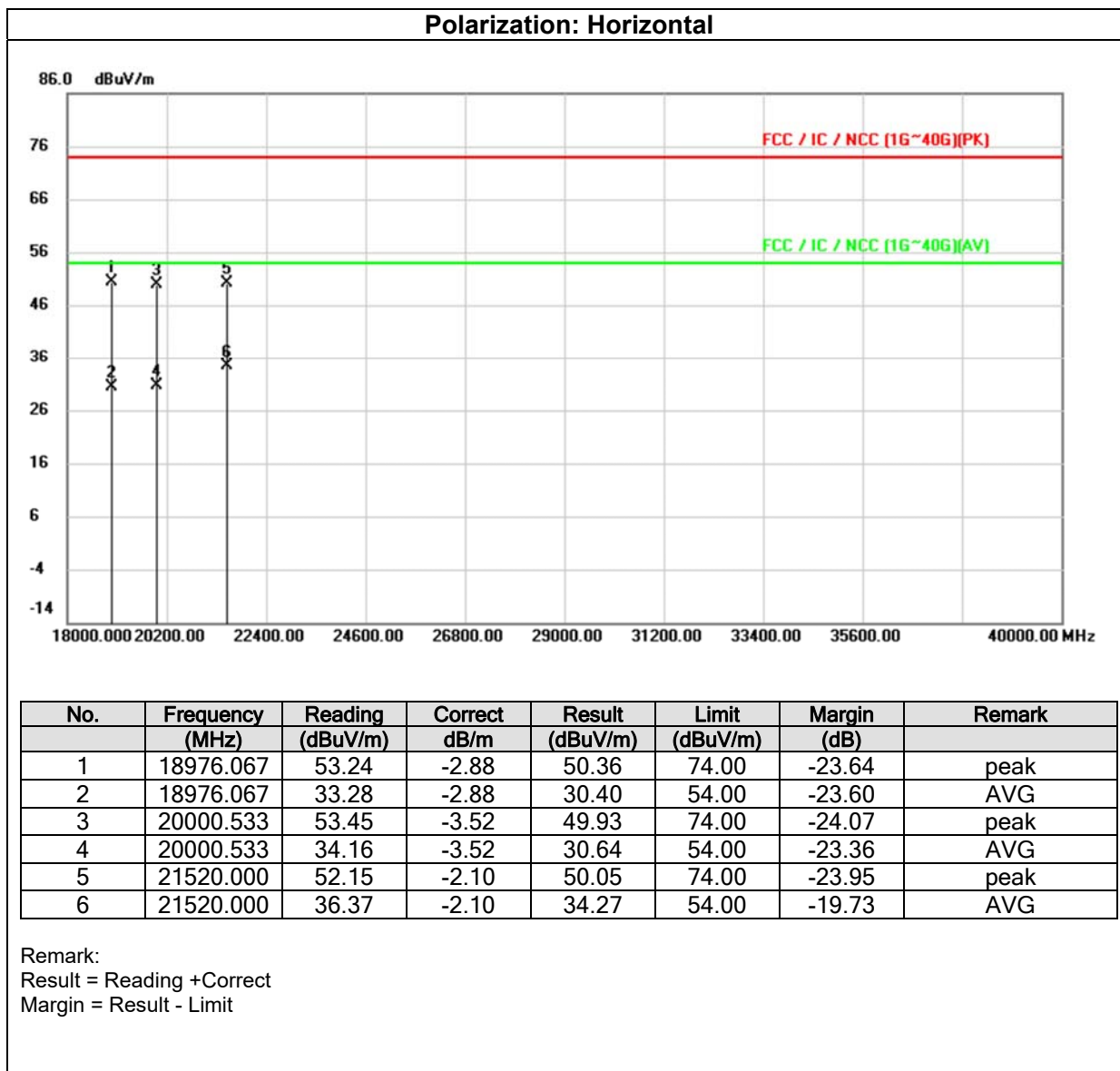

Test Mode:	Mode 2	Temperature:	25°C
Test Voltage:	AC 120V/60Hz	Humidity:	52%
Tested By:	Edison Lin	Test Date:	Aug. 22, 2019
Frequency Range	18GHz ~ 40GHz		

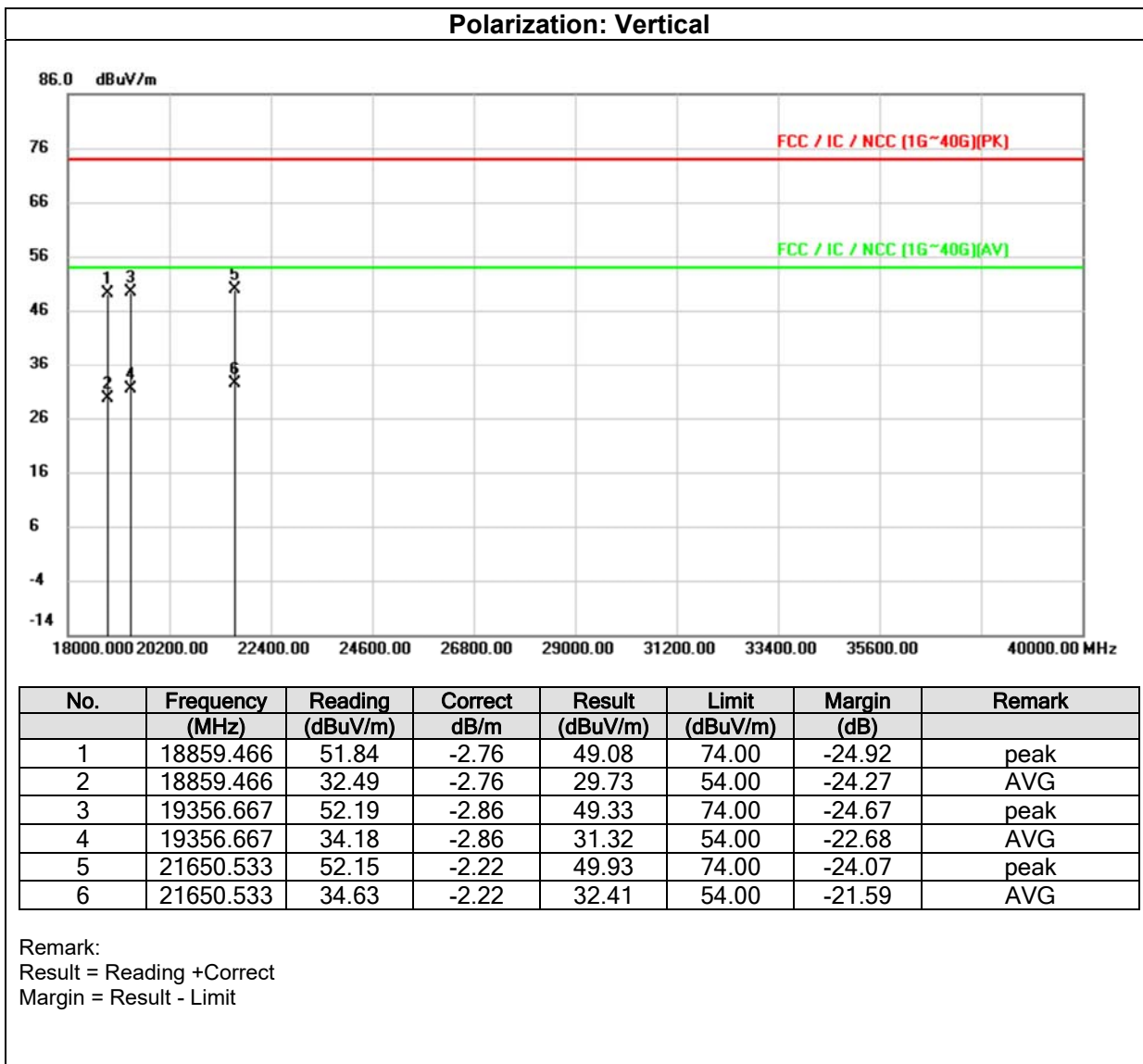

Appendix I: Photographs of Test Configuration

Conducted Emission

Mode 1



Radiated Emission

Below 1G/ Mode 2



Above 1G/ Mode 2

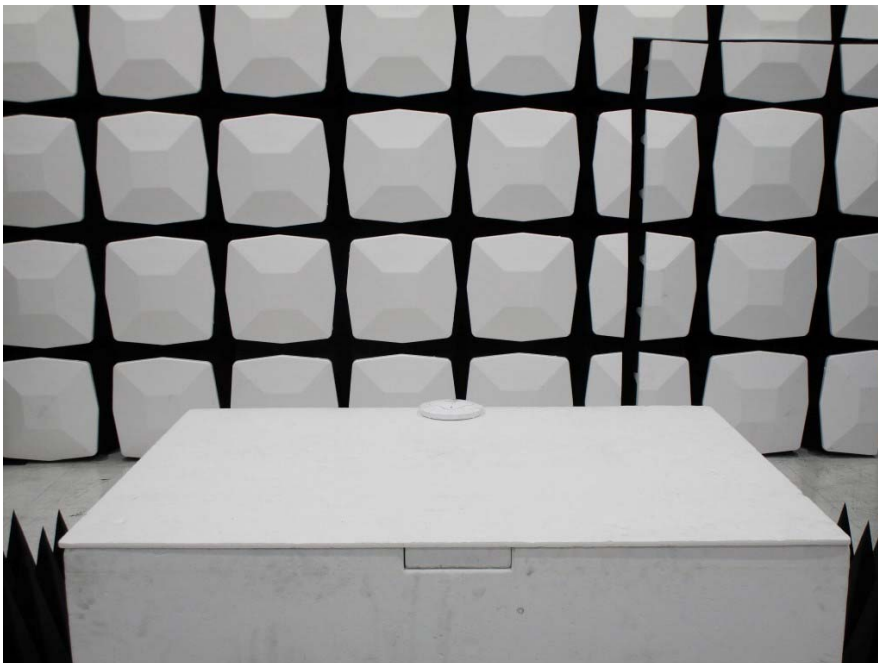
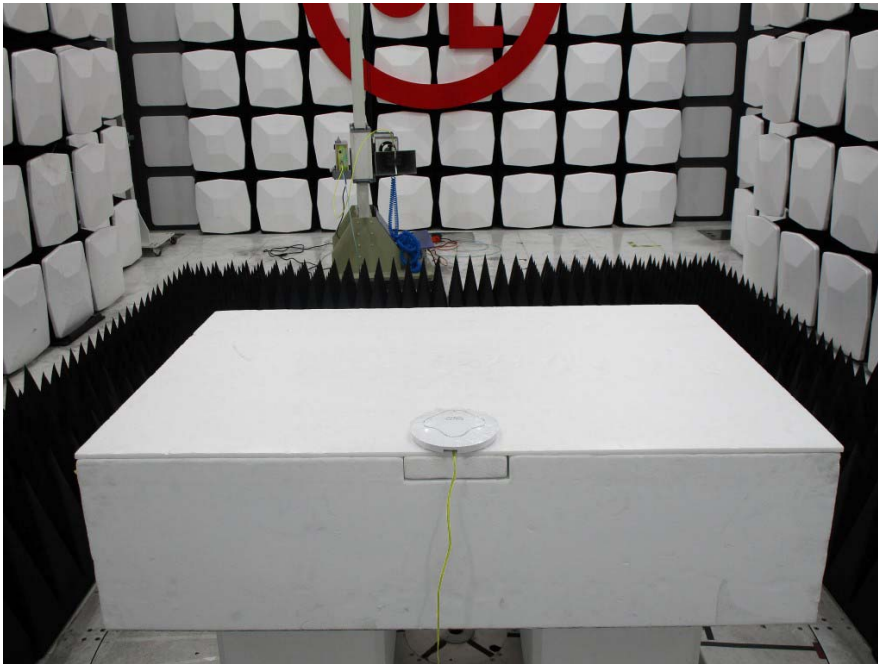

Appendix II: Photographs of the EUT

Please see the photographs of EUT in the test report no.: 4788947466 -EP.

END OF REPORT