

# DrayTek

## VigorAP 810

802.11n Access Point



*Your reliable networking solutions partner*

# User's Guide

**V2.7**

# **VigorAP 810**

## **Wireless Access Point**

### **User's Guide**

**Version: 2.7**

**Firmware Version: V1.3.4**

**(For future update, please visit DrayTek web site)**

**Date: October 13, 2021**

## Copyright Information

### Copyright Declarations

© All rights reserved. This publication contains information that is protected by copyright. No part may be reproduced, transmitted, transcribed, stored in a retrieval system, or translated into any language without written permission from the copyright holders.

### Trademarks

The following trademarks are used in this document:

- Microsoft is a registered trademark of Microsoft Corp.
- Windows, 8, 10 and Explorer are trademarks of Microsoft Corp.
- Apple and Mac OS are registered trademarks of Apple Inc.
- Other products may be trademarks or registered trademarks of their respective manufacturers.

## Safety Instructions and Approval

### Safety Instructions

- Read the installation guide thoroughly before you set up the modem.
- The modem is a complicated electronic unit that may be repaired only by authorized and qualified personnel. Do not try to open or repair the modem yourself.
- Do not place the modem in a damp or humid place, e.g. a bathroom.
- The modem should be used in a sheltered area, within a temperature range of +5 to +40 Celsius.
- Do not expose the modem to direct sunlight or other heat sources. The housing and electronic components may be damaged by direct sunlight or heat sources.
- Do not deploy the cable for LAN connection outdoor to prevent electronic shock hazards.
- Keep the package out of reach of children.
- When you want to dispose of the modem, please follow local regulations on conservation of the environment.

### Warranty

We warrant to the original end user (purchaser) that the modem will be free from any defects in workmanship or materials for a period of two (2) years from the date of purchase from the dealer. Please keep your purchase receipt in a safe place as it serves as proof of date of purchase. During the warranty period, and upon proof of purchase, should the product have indications of failure due to faulty workmanship and/or materials, we will, at our discretion, repair or replace the defective products or components, without charge for either parts or labor, to whatever extent we deem necessary to restore the product to proper operating condition. Any replacement will consist of a new or re-manufactured functionally equivalent product of equal value, and will be offered solely at our discretion. This warranty will not apply if the product is modified, misused, tampered with, damaged by an act of God, or subjected to abnormal working conditions. The warranty does not cover the bundled or licensed software of other vendors. Defects which do not significantly affect the usability of the product will not be covered by the warranty. We reserve the right to revise the manual and online documentation and to make changes from time to time in the contents hereof without obligation to notify any person of such revision or changes.

### Be a Registered Owner

Web registration is preferred. You can register your Vigor router via <https://myvigor.draytek.com>.

### Firmware & Tools Updates

Due to the continuous evolution of DrayTek technology, all modems will be regularly upgraded. Please consult the DrayTek web site for more information on newest firmware, tools and documents.

<https://www.draytek.com>

# Table of Contents

## 1

<b>Introduction .....</b>	<b>1</b>
1.1 Introduction .....	1
1.2 LED Indicators and Connectors .....	2
1.3 Hardware Installation .....	4
1.3.1 Wired Connection for PC in LAN .....	4
1.3.2 Wired Connection for Notebook in WLAN .....	5
1.3.3 Wireless Connection.....	6
1.3.4 POE Connection .....	7

## 2

<b>Network Configuration.....</b>	<b>9</b>
2.1 Windows 7 IP Address Setup.....	9
2.2 Windows 2000 IP Address Setup.....	11
2.3 Windows XP IP Address Setup.....	12
2.4 Windows Vista IP Address Setup.....	13
2.5 Accessing to Web User Interface .....	14
2.6 Changing Password .....	15
2.7 Quick Start Wizard .....	16
2.7.1 Configuring Wireless Settings – General.....	16
2.7.2 Configuring 2.4GHz Wireless Settings Based on the Operation Mode.....	17
2.7.3 Finishing the Wireless Settings Wizard .....	23
2.8 Online Status .....	24

## 3

<b>Advanced Configuration .....</b>	<b>25</b>
3.1 Operation Mode .....	26
3.2 LAN .....	27
3.2.1 General Setup.....	27
3.2.2 Web Portal .....	30
3.3 Central AP Management .....	33
3.3.1 General Setup.....	33
3.3.2 APM Log .....	34
3.3.3 Overload Management .....	34
3.3.4 Status of Settings.....	36
3.4 General Concepts for Wireless LAN .....	37
3.5 Wireless LAN Settings for AP Mode .....	39
3.5.1 General Setup.....	40

3.5.2 Security .....	42
3.5.3 Access Control.....	44
3.5.4 WPS.....	46
3.5.5 Advanced Setting.....	47
3.5.6 AP Discovery .....	49
3.5.7 Bandwidth Management.....	51
3.5.8 Airtime Fairness.....	52
3.5.9 Station Control .....	54
3.5.10 Roaming .....	55
3.5.11 Station List .....	57
3.6 Wireless LAN Settings for Station-Infrastructure Mode .....	59
3.6.1 General Setup.....	59
3.6.2 Site Survey .....	64
3.6.3 Statistics.....	65
3.6.4 WPS (Wi-Fi Protected Setup).....	65
3.7 Wireless LAN Settings for AP Bridge-Point to Point/AP Bridge-Point to Multi-Point Mode ..	67
3.7.1 General Setup.....	67
3.7.2 Advanced Setting.....	69
3.7.3 AP Discovery .....	71
3.7.4 WDS AP Status .....	73
3.8 Wireless LAN Settings for AP Bridge-WDS Mode .....	74
3.8.1 General Setup.....	75
3.8.2 Security .....	78
3.8.3 Access Control.....	81
3.8.4 WPS.....	82
3.8.5 Advanced Setting.....	83
3.8.6 AP Discovery .....	85
3.8.7 WDS AP Status .....	86
3.8.8 Bandwidth Management.....	87
3.8.9 Airtime Fairness.....	88
3.8.10 Station Control .....	90
3.8.11 Roaming .....	91
3.8.12 Station List .....	93
3.9 Wireless LAN Settings for Universal Repeater Mode .....	94
3.9.1 General Setup.....	95
3.9.2 Security .....	97
3.9.3 Access Control.....	100
3.9.4 WPS.....	101
3.9.5 Advanced Setting.....	102
3.9.6 AP Discovery .....	104
3.9.7 Universal Repeater .....	105
3.9.8 Bandwidth Management.....	107
3.9.9 Airtime Fairness.....	109
3.9.10 Station Control .....	111
3.9.11 Roaming .....	112
3.9.12 Station List .....	114
3.10 RADIUS Setting .....	116
3.10.1 RADIUS Server.....	116
3.10.2 Certificate Management .....	117
3.11 Applications .....	118
3.11.1 Schedule.....	118
3.11.2 Apple iOS Keep Alive .....	121
3.11.3 Wi-Fi Auto On/Off .....	122
3.11.4 Temperature Sensor.....	122

3.12 Mobile Device Management .....	125
3.12.1 Detection.....	125
3.12.2 Policies .....	126
3.12.3 Statistics .....	127
3.13 System Maintenance.....	128
3.13.1 System Status.....	128
3.13.2 TR-069.....	130
3.13.3 Administrator Password.....	132
3.13.4 Configuration Backup .....	133
3.13.5 Syslog/Mail Alert .....	135
3.13.6 Time and Date .....	136
3.13.7 SNMP.....	137
3.13.8 Management.....	138
3.13.9 Reboot System .....	139
3.13.10 Firmware Upgrade .....	139
3.14 Diagnostics.....	140
3.14.1 System Log.....	140
3.14.2 Speed Test .....	141
3.14.3 Traffic Graph.....	141
3.14.4 Data Flow Monitor.....	142
3.14.5 WLAN Statistics .....	143
3.14.6 Station Statistics .....	144
3.14.7 Interference Monitor.....	146
3.14.8 Station Airtime .....	148
3.14.9 Station Traffic Graph.....	149
3.14.10 Station Link Speed.....	150
3.15 Support Area .....	150

## 4

### **Application and Examples.....151**

4.1 How to set different segments for different SSIDs in VigorAP 810 .....	151
--	-----

## 5

### **Trouble Shooting.....155**

5.1 Checking If the Hardware Status Is OK or Not.....	155
5.2 Checking If the Network Connection Settings on Your Computer Is OK or Not .....	156
5.3 Pinging the Modem from Your Computer.....	159
5.4 Backing to Factory Default Setting If Necessary .....	160
5.5 Contacting DrayTek.....	161

# 1

# Introduction

## 1.1 Introduction

Thank you for purchasing this VigorAP 810! With this high cost-efficiency VigorAP 810, computers and wireless devices which are compatible with 802.11n can connect to existing wired Ethernet network via this VigorAP 810, at the speed of 300Mbps.

Easy install procedures allows any computer users to setup a network environment in very short time - within minutes, even inexperienced users. Just follow the instructions given in this user manual, you can complete the setup procedure and release the power of this access point all by yourself!

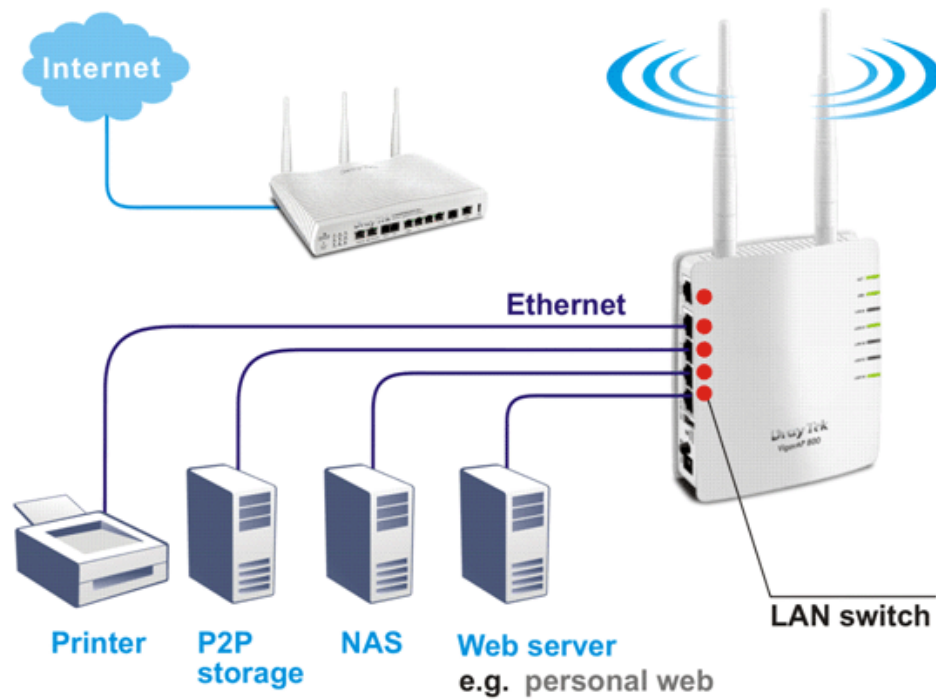

## 1.2 LED Indicators and Connectors

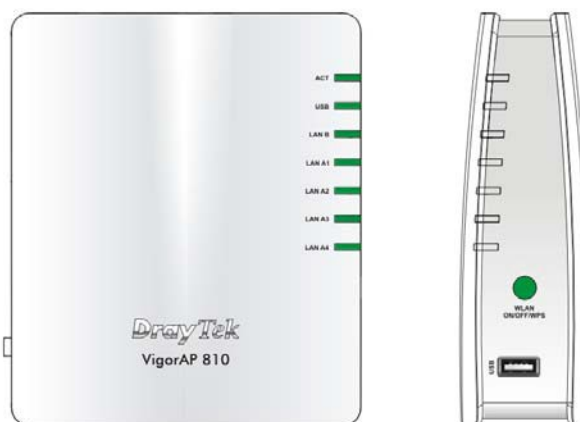

Before you use the Vigor modem, please get acquainted with the LED indicators and connectors first.



	Status	Explanation
ACT	Off	The system is not ready or is failed.
	Blinking	The system is ready and can work normally.
USB	On	A USB device is connected and active.
	Blinking	The data is transmitting.
LAN B	On	A normal connection is through its corresponding port.
	Off	LAN is disconnected.
	Blinking	Data is transmitting (sending/receiving).
LAN A1 - A4	On	A normal connection is through its corresponding port.
	Off	LAN is disconnected.
WLAN (Green LED) on WLAN button	On	Press the button and release it within 2 seconds. When the wireless function is ready, the green LED will be on.
	Off	Press the button and release it within 2 seconds to turn off the WLAN function. When the wireless function is not ready, the LED will be off.
	Blinking (Green)	Data is transmitting (sending/receiving).
WPS (Orange LED) on WLAN button	Blinking (Orange)	When WPS function is enabled by web user interface, press this button for more than 2 seconds to wait for client's device making network connection through WPS. When the orange LED blinks with 1 second cycle for 2 minutes, it means that the AP is waiting for wireless client to connect with it.
USB		Connector for a printer.

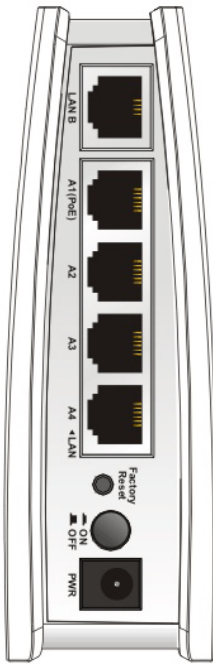



Interface	Description
LAN B	Connector for xDSL / Cable modem (Giga level) or router.
LAN A1 (PoE) - A4	Connector for xDSL / Cable modem (Giga level) / computer or router.
	Restore the default settings. Usage: Turn on the AP. Press the button and keep for more than 6 seconds. Then the AP will restart with the factory default configuration.
	ON/OFF: Power switch.
	PWR: Connector for a power adapter.

## 1.3 Hardware Installation

This section will guide you to install the VigorAP 810 through hardware connection and configure the device's settings through web browser.

Before starting to configure VigorAP 810, you have to connect your devices correctly.

### 1.3.1 Wired Connection for PC in LAN

1. Connect VigorAP 810 to ADSL modem, router, or switch/hub in your network through the **LAN A** port of the access point by Ethernet cable.
2. Connect a computer to other available LAN A port. Make sure the subnet IP address of the PC is the same as VigorAP 810 management IP, e.g., **192.168.1.X**.
3. Connect the A/C power adapter to the wall socket, and then connect it to the PWR connector of the access point.
4. Power on VigorAP 810.
5. Check all LEDs on the front panel. **ACT** LED should blink and **LAN** LEDs should be on if the access point is correctly connected to the ADSL modem or router.

(For the detailed information of LED status, please refer to section 1.2.)

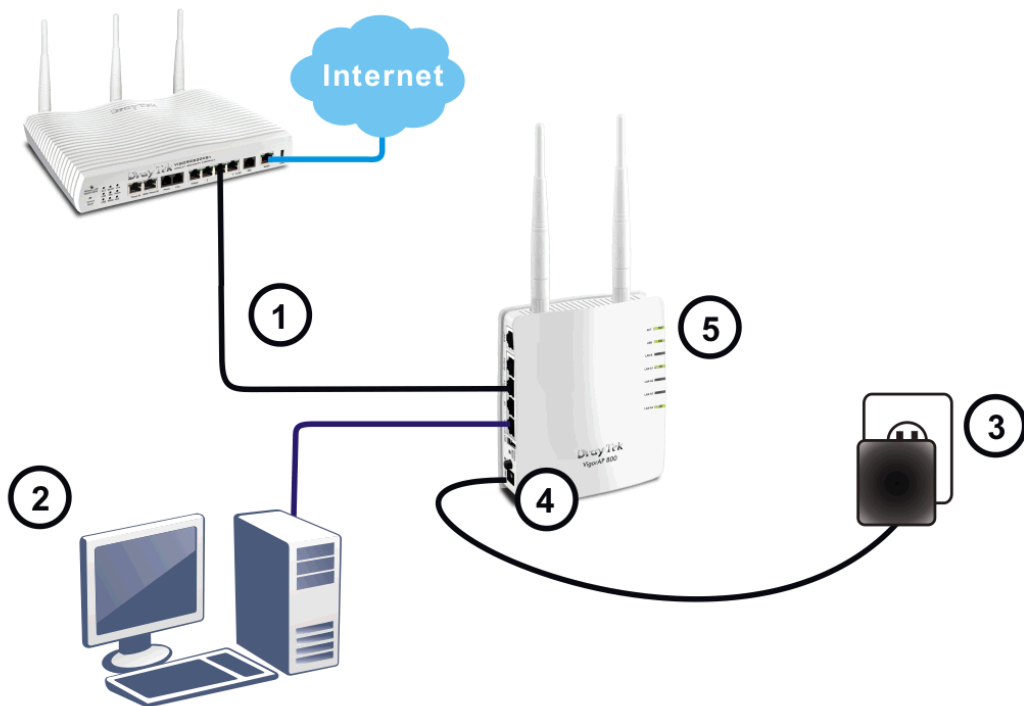

### 1.3.2 Wired Connection for Notebook in WLAN

1. Connect VigorAP 810 to ADSL modem or router in your network through the LAN A port of the access point by Ethernet cable.
2. Connect the A/C power adapter to the wall socket, and then connect it to the PWR connector of the access point.
3. Power on VigorAP 810.
4. Check all LEDs on the front panel. **ACT** LED should be steadily on, **LAN** LEDs should be on if the access point is correctly connected to the ADSL modem or router.

(For the detailed information of LED status, please refer to section 1.2.)

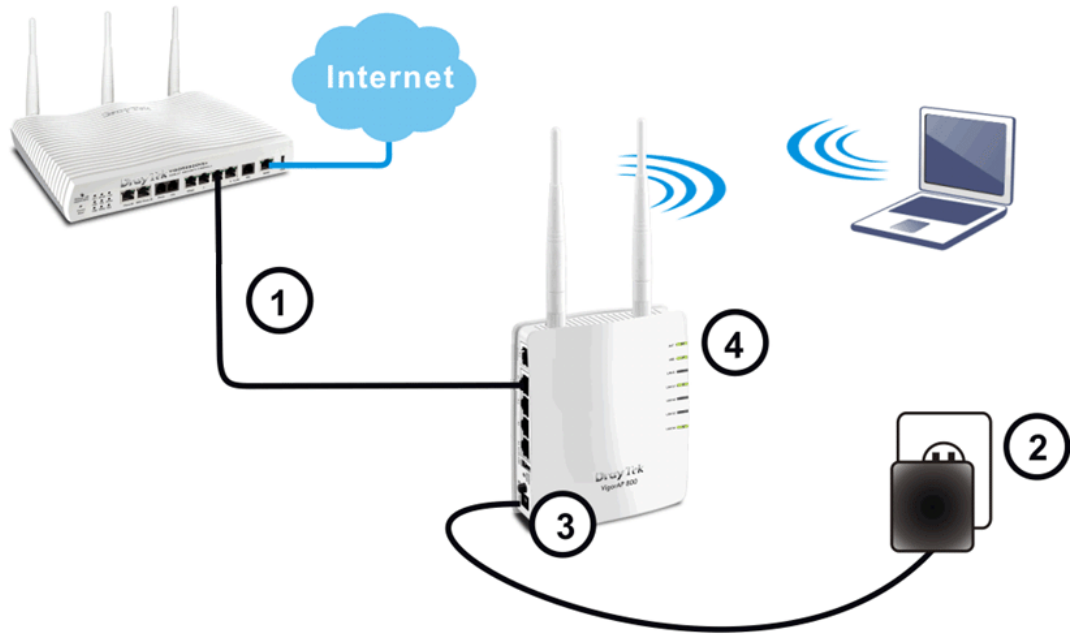

### 1.3.3 Wireless Connection

VigorAP 810 can access Internet via an ADSL modem, router, or switch/hub in your network through wireless connection.

1. Connect VigorAP 810 to ADSL modem or router via wireless network.
2. Connect the A/C power adapter to the wall socket, and then connect it to the PWR connector of the access point.
3. Power on VigorAP 810.
4. Check all LEDs on the front panel. **ACT** LED should be steadily on, **LAN** LEDs should be on if VigorAP 810 is correctly connected to the ADSL modem, router or switch/hub.

(For the detailed information of LED status, please refer to section 1.2.)



### 1.3.4 POE Connection

VigorAP 810 can gain the power from the connected switch, e.g., VigorSwitch P2260. PoE (Power over Ethernet) can break the install limitation caused by the fixed power supply.

1. Connect VigorAP 810 to a switch in your network through the **LAN A1 (PoE)** port of the access point by Ethernet cable.
2. Connect a computer to VigorSwitch P2260. Make sure the subnet IP address of the PC is the same as VigorAP 810 management IP, e.g., **192.168.1.X**.
3. Power on VigorAP 810.
4. Check all LEDs on the front panel. **ACT** LED should be steadily on, **LAN** LEDs should be on if the access point is correctly connected to the ADSL modem, router or switch/hub.

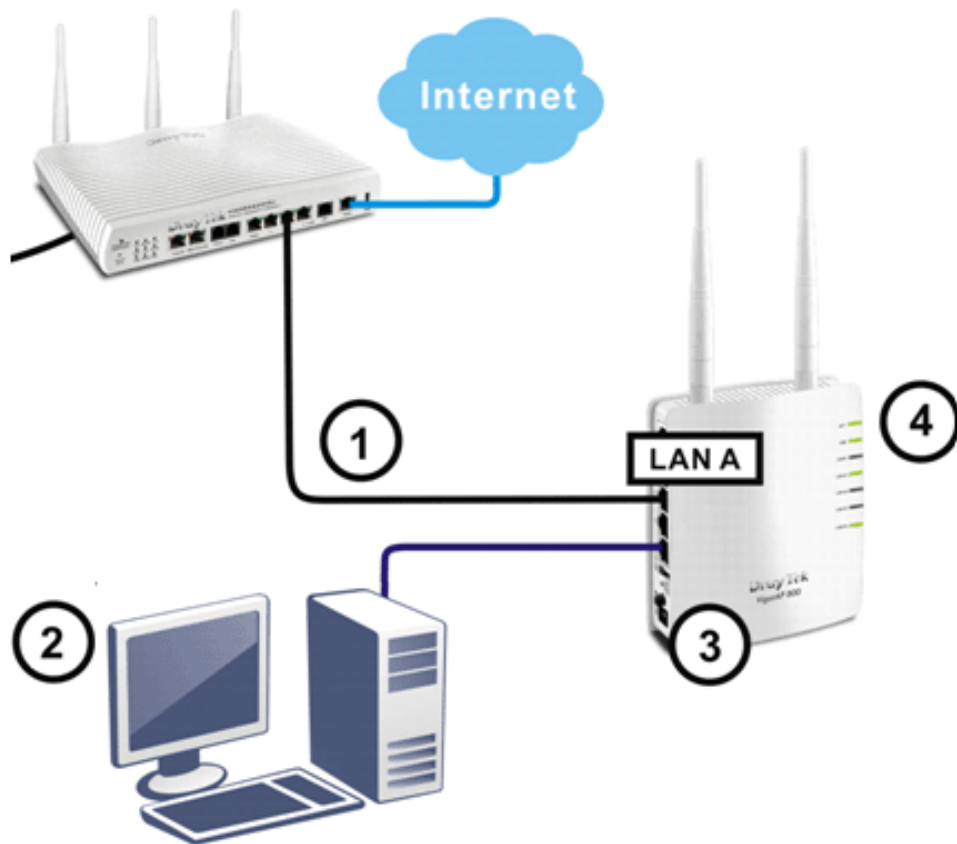

This page is left blank.

# 2

## Network Configuration

After the network connection is built, the next step you should do is setup VigorAP 810 with proper network parameters, so it can work properly in your network environment.

Before you can connect to the access point and start configuration procedures, your computer must be able to get an IP address automatically (use dynamic IP address). If it's set to use static IP address, or you're unsure, please follow the following instructions to configure your computer to use dynamic IP address:

For the default IP address of this AP is set "192.168.1.2", we recommend you to use "192.168.1.X (except 2)" in the field of IP address on this section for your computer.  
*If the operating system of your computer is...*

- Windows 7** - please go to section 2.1
- Windows 2000** - please go to section 2.2
- Windows XP** - please go to section 2.3
- Windows Vista** - please go to section 2.4

### 2.1 Windows 7 IP Address Setup

Click **Start** button (it should be located at lower-left corner of your computer), then click Control Panel. Double-click **Network and Internet**, and the following window will appear. Click **Network and Sharing Center**.

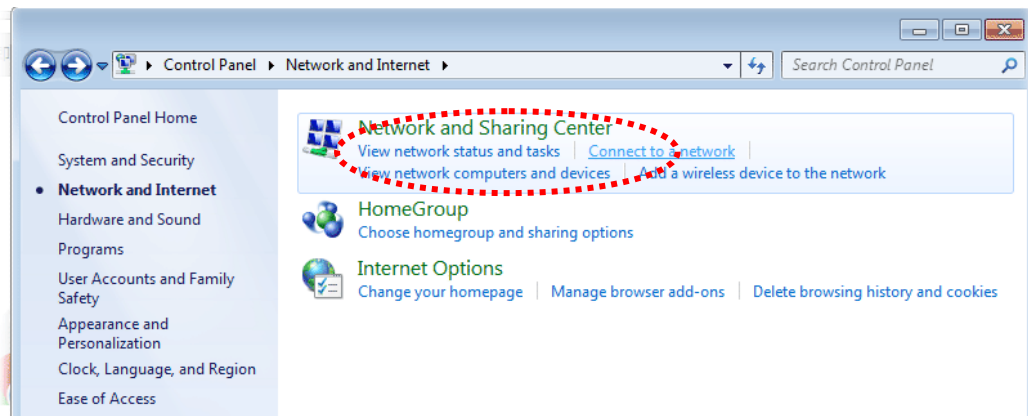

Next, click **Change adapter settings** and click **Local Area Connection**.

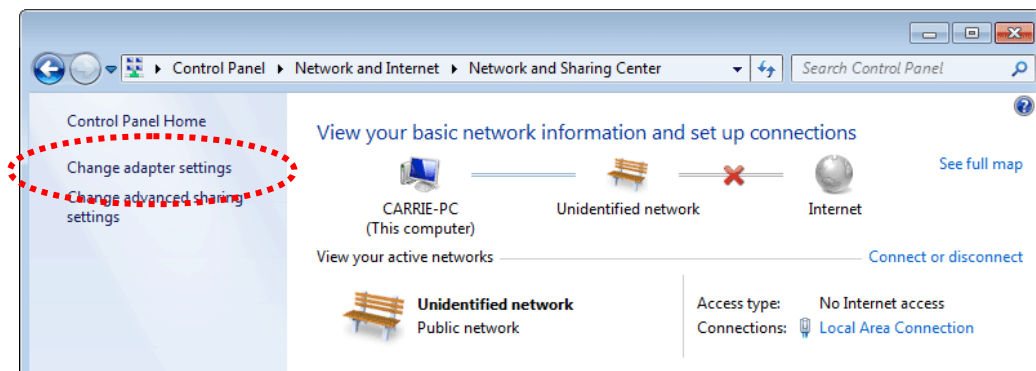

Then, select **Internet Protocol Version 4 (TCP/IPv4)** and click **Properties**.

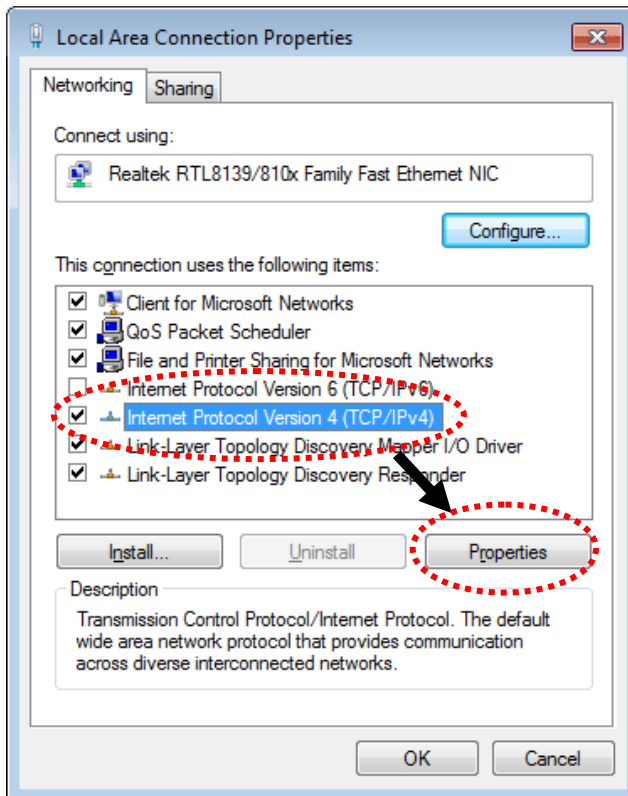

Under the General tab, click **Use the following IP address**. Then input the following settings in respective field and click **OK** when finish.

IP address: **192.168.1.9**

Subnet Mask: **255.255.255.0**

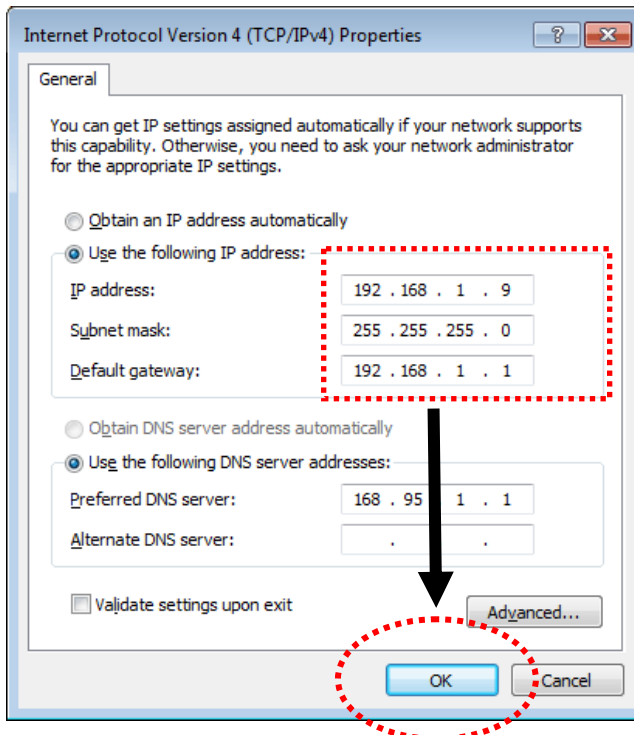



## 2.2 Windows 2000 IP Address Setup

Click **Start** button (it should be located at lower-left corner of your computer), then click control panel. Double-click **Network and Dial-up Connections** icon, double click **Local Area Connection**, and **Local Area Connection Properties** window will appear. Select **Internet Protocol (TCP/IP)**, then click **Properties**.

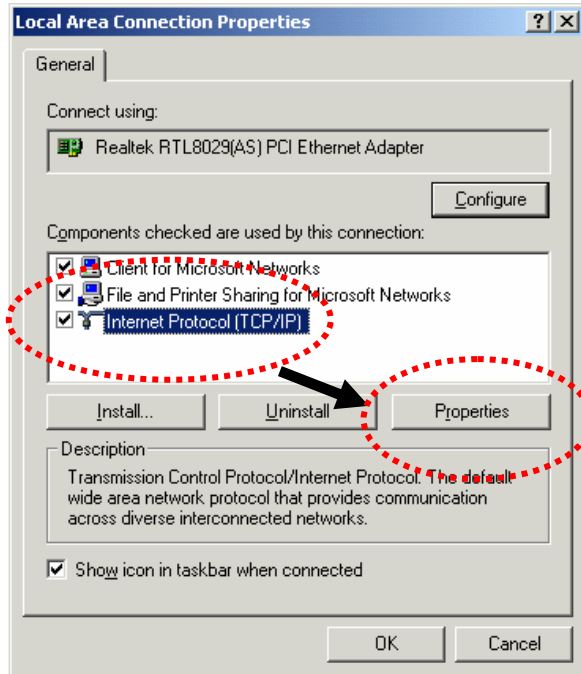

Select **Use the following IP address**, then input the following settings in respective field and click **OK** when finish.

IP address: **192.168.1.9**

Subnet Mask: **255.255.255.0**

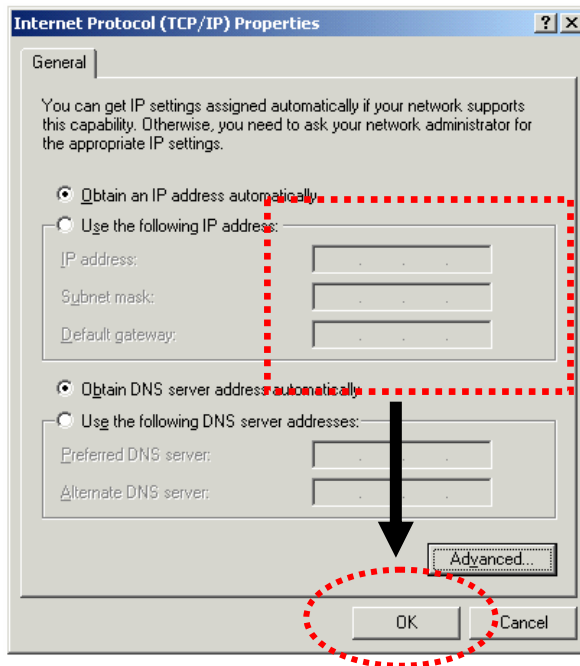

## 2.3 Windows XP IP Address Setup

Click **Start** button (it should be located at lower-left corner of your computer), then click control panel. Double-click **Network and Internet Connections** icon, click **Network Connections**, and then double-click **Local Area Connection, Local Area Connection Status** window will appear, and then click **Properties**.

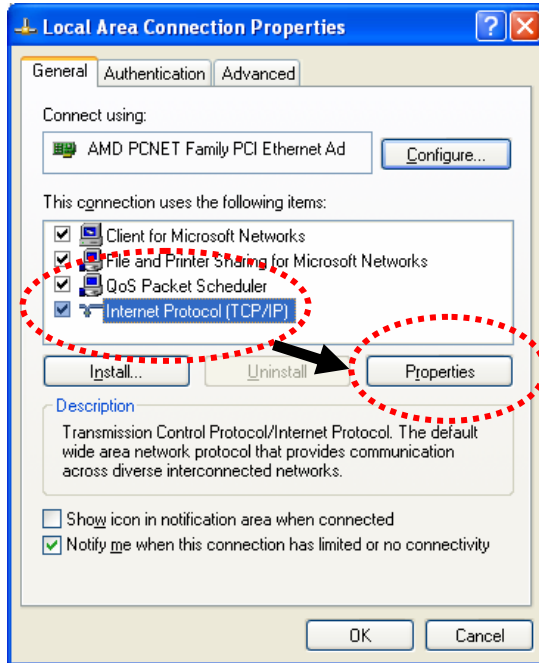

Select **Use the following IP address**, then input the following settings in respective field and click **OK** when finish:

IP address: **192.168.1.9**

Subnet Mask: **255.255.255.0**.

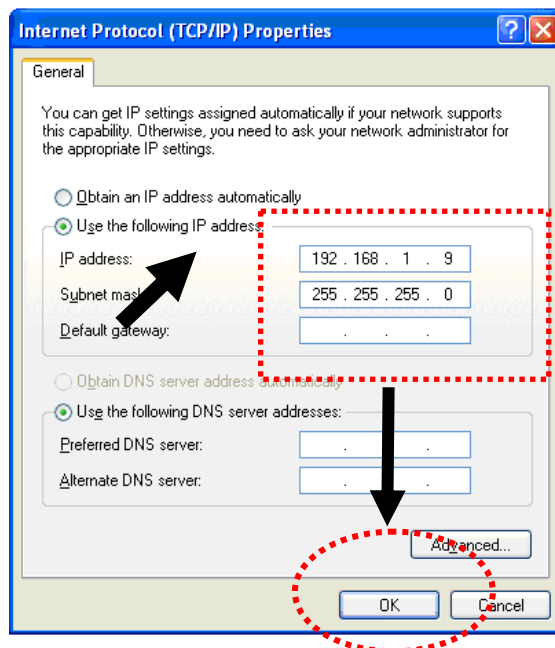

## 2.4 Windows Vista IP Address Setup

Click **Start** button (it should be located at lower-left corner of your computer), then click control panel. Click **View Network Status and Tasks**, then click **Manage Network Connections**. Right-click **Local Area Network**, then select **'Properties'**. **Local Area Connection Properties** window will appear, select **Internet Protocol Version 4 (TCP / IPv4)**, and then click **Properties**.

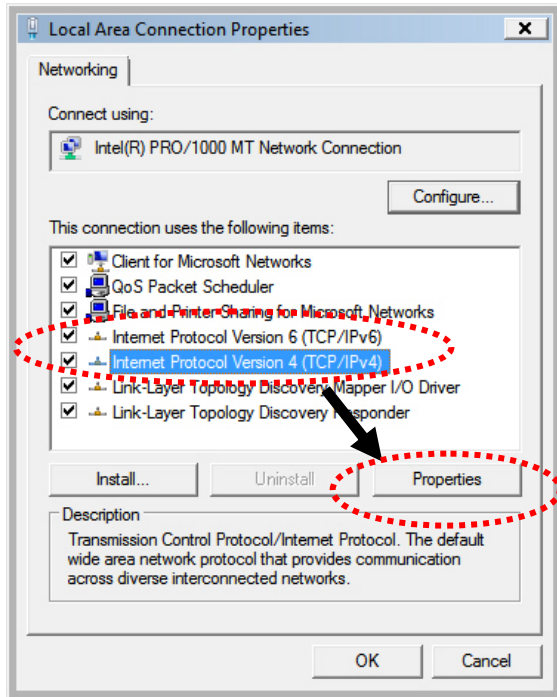

Select **Use the following IP address**, then input the following settings in respective field and click **OK** when finish:

IP address: **192.168.1.9**

Subnet Mask: **255.255.255.0**

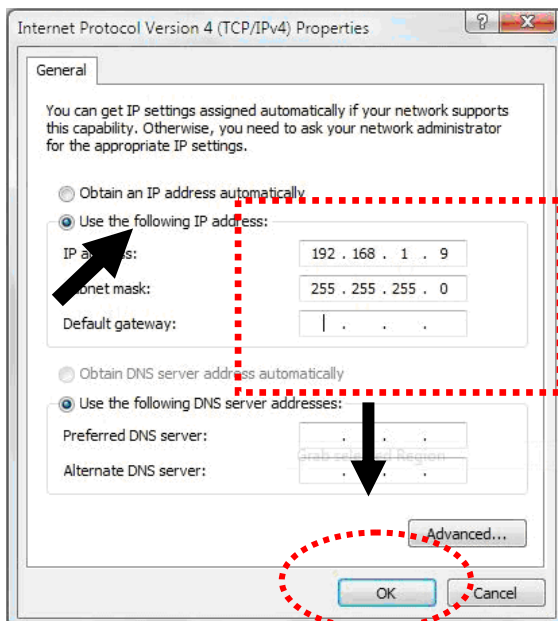

## 2.5 Accessing to Web User Interface

All functions and settings of this access point must be configured via web user interface. Please start your web browser (e.g., IE).

1. Make sure your PC connects to the VigorAP 810 correctly.
2. Open a web browser on your PC and type **http://192.168.1.2**. A pop-up window will open to ask for username and password. Please type “admin/admin” on Username/Password and click **OK**.

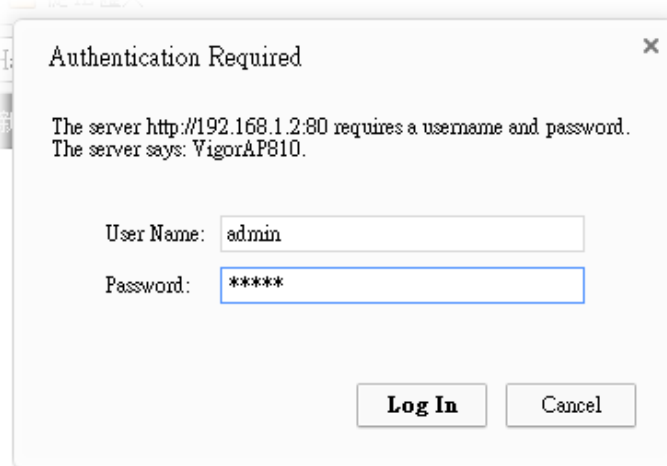

**Note 1:** You may either simply set up your computer to get IP dynamically from the router or set up the IP address of the computer to be in the same subnet as **the IP address of VigorAP 810**.

- If there is no DHCP server on the network, then VigorAP 810 will have an IP address of 192.168.1.2.
- If there is DHCP available on the network, then VigorAP 810 will receive its IP address via the DHCP server.

3. The **Main Screen** will pop up.

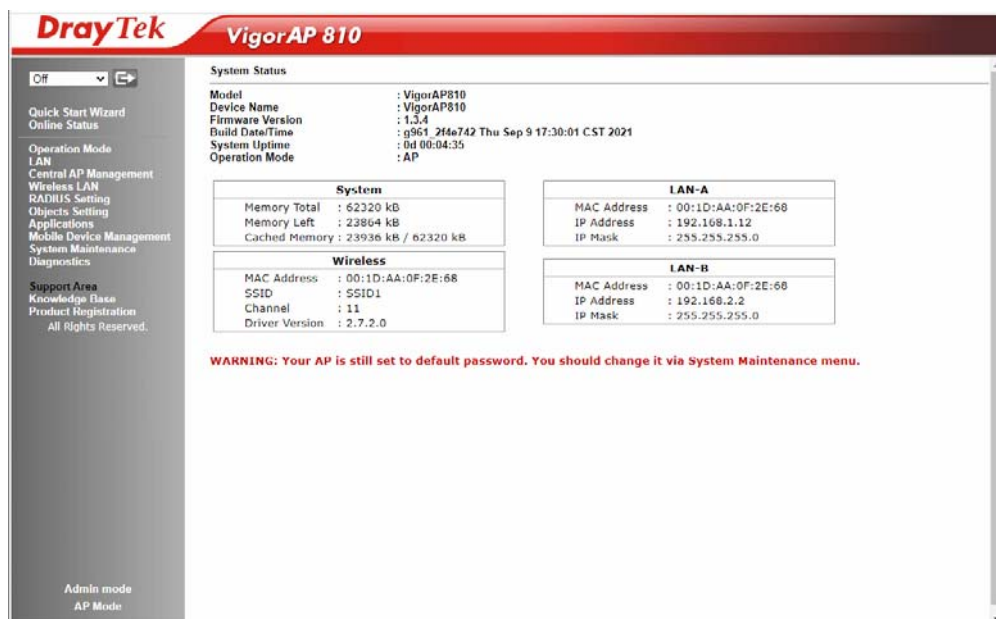

**Note:** If you fail to access to the web configuration, please go to “Trouble Shooting” for detecting and solving your problem. For using the device properly, it is necessary for you to change the password of web configuration for security and adjust primary basic settings.

## 2.6 Changing Password

1. Please change the password for the original security of the modem.
2. Go to **System Maintenance** page and choose **Administration Password**.

System Maintenance >> Administration Password

### Administrator Settings

Account	<input type="text" value="admin"/>
Old Password	<input type="password" value="*****"/>
New Password	<input type="password" value="*****"/>
Confirm Password	<input type="password" value="*****"/>
Password Strength:	<input type="button" value="Weak"/> <input checked="" type="button" value="Medium"/> <input type="button" value="Strong"/>
Strong password requirements:	
1. Have at least one upper-case letter and one lower-case letter.	
2. Including non-alphanumeric characters is a plus.	

**Note :** Authorization Account can contain only a-z A-Z 0-9 , ~ ` ! @ \$ % ^ \* ( ) \_ - + = { } [ ] | ; < > . ?  
Authorization Password can contain only a-z A-Z 0-9 , ~ ` ! @ # \$ % ^ & \* ( ) \_ - + = { } [ ] \ ; < > . ? /

3. Enter the new login password on the field of **Password**. Then click **OK** to continue.
4. Now, the password has been changed. Next time, use the new password to access the Web User Interface for this modem.

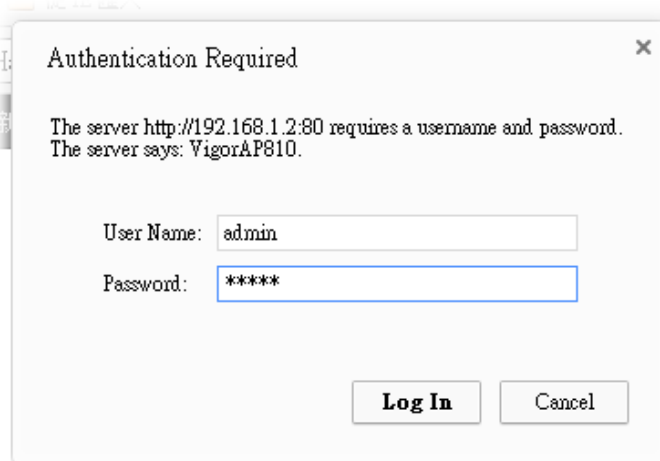

The image shows a dialog box titled "Authentication Required" with a close button (X) in the top right corner. The text inside the dialog box reads: "The server http://192.168.1.2:80 requires a username and password. The server says: VigorAP810." Below this text are two input fields: "User Name:" with the value "admin" and "Password:" with the value "\*\*\*\*\*". At the bottom of the dialog box are two buttons: "Log In" and "Cancel".

## 2.7 Quick Start Wizard

Quick Start Wizard will guide you to configure 2.4G wireless setting, 5G wireless setting and other corresponding settings for Vigor Access Point step by step.

### 2.7.1 Configuring Wireless Settings – General

This page displays general settings for the operation mode selected.

Quick Start Wizard >> Operation Mode

**Wireless LAN(2.4GHz)**  
Operation Mode :  

VigorAP acts as a bridge between wireless devices and wired Ethernet network, and exchanges data between them.

---

Progress bar: Operation Mode (filled) | Wireless(2.4GHz) (empty)

Available settings are explained as follows:

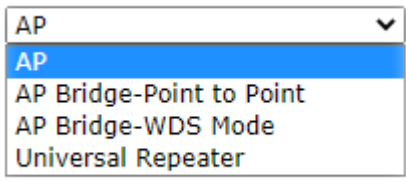
Item	Description
<b>Operation Mode</b>	There are six operation modes for wireless connection. Settings for each mode are different. 

After finishing this web page configuration, please click **Next** to continue.

## 2.7.2 Configuring 2.4GHz Wireless Settings Based on the Operation Mode

In this page, the advanced settings will vary according to the operation mode chosen on 2.7.1.

### Settings for AP

When you choose AP as the operation mode for wireless LAN (2.4GHz), you will need to configure the following page.

Quick Start Wizard >> Wireless LAN (2.4GHz)

---

Channel :

Main SSID :

Security Key:

Enable Guest Wireless

    SSID:

    Security Key:

Enable Bandwidth Limit

Enable Station Control

---

Operation Mode Wireless(2.4GHz)

Available settings are explained as follows:

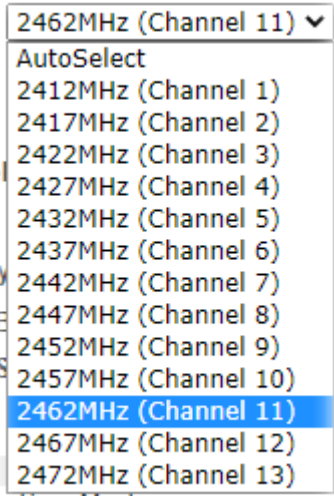
Item	Description
Channel	<p>Means the channel frequency of the wireless LAN. The default channel is 6. You may switch channel if the selected channel is under serious interference. If you have no idea of choosing the frequency, please select <b>AutoSelect</b> to let system determine for you.</p> 
Main SSID	Set a name for VigorAP to be identified.
Security Key	Type <b>8~63</b> ASCII characters, such as 012345678..(or 64

	Hexadecimal digits leading by 0x, such as "0x321253abcde...").
<b>Enable Guest Wireless</b>	<p>Check the box to enable the <b>guest</b> wireless setting.</p> <p>Such feature is especially useful for free Wi-Fi service. For example, a coffee shop offers free Wi-Fi service for its guests for one hour every day.</p> <p><b>SSID</b> – Set a name for VigorAP which can be identified and connected by wireless guest.</p> <p><b>Security Key</b> – Set <b>8~63</b> ASCII characters or <b>8~63</b> ASCII characters which can be used for logging into VigorAP by wireless guest.</p> <p><b>Enable Bandwidth Limit</b> – Check the box to define the maximum speed of the data uploading/downloading which will be used for the guest connecting to Vigor device with the same SSID.</p> <ul style="list-style-type: none"> <li>● <b>Upload Limit</b> – Scroll the radio button to choose the value you want.</li> <li>● <b>Download Limit</b> – Scroll the radio button to choose the value you want.</li> </ul> <p><b>Enable Station Control</b> – Check the box to set the duration for the guest connecting /reconnecting to Vigor device.</p> <ul style="list-style-type: none"> <li>● <b>Connection Time</b> – Scroll the radio button to choose the value you want.</li> <li>● <b>Reconnection Time</b> – Scroll the radio button to choose the value you want.</li> </ul>

After finishing this web page configuration, please click **Next** to continue.



## Settings for AP Bridge-Point to Point

When you choose AP Bridge- Point to Point as **Operation Mode** and click **Next**, you will need to configure the following page:

Quick Start Wizard >> Wireless LAN (2.4GHz)

AP Discovery :

**Note:** Enter the configuration of APs which VigorAP want to connect.

Phy Mode : HTMIX
<b>Security :</b> <input checked="" type="radio"/> Disabled <input type="radio"/> WEP <input type="radio"/> TKIP <input type="radio"/> AES Key : <input type="text"/>
<b>Peer Mac Address:</b> <input type="text"/> : <input type="text"/> : <input type="text"/> : <input type="text"/> : <input type="text"/> : <input type="text"/>

Operation Mode

Wireless(2.4GHz)

< Back

Next >

Cancel

Available settings are explained as follows:

Item	Description
<b>AP Discovery</b>	Click this button to open the AP Discovery dialog. VigorAP can scan all regulatory channels and find working APs in the neighborhood.
<b>Phy Mode</b>	Data will be transmitted via HTMIX communication channel. Each access point should be setup to the same <b>Phy</b> mode for connecting with each other.
<b>Security</b>	Select WEP, TKIP or AES as the encryption algorithm. Type the key number if required.
<b>Peer MAC Address</b>	Type the peer MAC address for the access point that VigorAP 810 connects to.

## Settings for AP Bridge-WDS

When you choose AP Bridge- WDS as **Operation Mode** and click **Next**, you will need to configure the following page:

Quick Start Wizard >> Wireless LAN (2.4GHz)

AP Discovery :

**Note:** Enter the configuration of APs which VigorAP want to connect.

Remote AP should always set LAN-A MAC address to connect VigorAP WDS.

Phy Mode : HTMIX
Security : <input checked="" type="radio"/> Disabled <input type="radio"/> WEP <input type="radio"/> TKIP <input type="radio"/> AES Key : <input type="text"/>
Peer Mac Address: <input type="text"/> : <input type="text"/> : <input type="text"/> : <input type="text"/> : <input type="text"/> : <input type="text"/>

Main SSID :

Security Key:

Operation Mode	Wireless(2.4GHz)
<input type="button" value=" &lt; Back"/>	<input type="button" value=" Next &gt;"/>
<input type="button" value=" Cancel"/>	

Available settings are explained as follows:

Item	Description
<b>AP Discovery</b>	Click this button to open the AP Discovery dialog. VigorAP can scan all regulatory channels and find working APs in the neighborhood.
<b>Phy Mode</b>	Data will be transmitted via HTMIX communication channel. Each access point should be setup to the same <b>Phy</b> mode for connecting with each other.
<b>Security</b>	Select WEP, TKIP or AES as the encryption algorithm. Type the key number if required. Or, you can click Disable to disable the function.
<b>Peer MAC Address</b>	Type the peer MAC address for the access point that VigorAP 810 connects to.
<b>Main SSID</b>	Set a name for VigorAP to be identified.
<b>Security Key</b>	Type <b>8~63</b> ASCII characters, such as 012345678..(or 64 Hexadecimal digits leading by 0x, such as "0x321253abcde...").

## Advanced Settings for Universal Repeater

When you choose Bridge-Universal Repeater as **Operation Mode** and click **Next**, you will need to configure the following page:

Quick Start Wizard >> Wireless LAN (2.4GHz)

---

Universal Repeater Parameters

Please input the SSID you want to connect to : AP Discovery

SSID

MAC Address (Optional)

Channel

Security Mode

Encryption Type

Security Key

Note: If Channel is modified, the Channel setting of AP would also be changed.

SSID:

Security Key:

Enable Guest Wireless

    SSID:

    Security Key:

Enable Bandwidth Limit

Enable Station Control

---

Operation Mode

Wireless(2.4GHz)

Available settings are explained as follows:

Item	Description
<b>Universal Repeater Parameters</b>	
<b>AP Discovery</b>	Click this button to open the AP Discovery dialog. VigorAP can scan all regulatory channels and find working APs in the neighborhood.
<b>SSID / MAC Address (Optional)</b>	SSID means the identification of the wireless LAN. After choosing one of the AP from AP Discovery window and clicking <b>OK</b> , the settings (SSID and MAC Address) related to the selected AP will be displayed on these fields automatically. Later, VigorAP will be allowed to access Internet through the selected AP, by using SSID displayed here.
<b>Channel</b>	Means the channel frequency of the wireless LAN. The default channel is 6. You may switch channel if the selected channel is under serious interference.
<b>Security Mode</b>	There are several modes provided for you to choose. Each mode will bring up different parameters (e.g., WEP keys, Pass Phrase) for you to configure.
<b>Encryption Type for Open/Shared</b>	This option is available when Open/Shared is selected as Security Mode. Choose <b>None</b> to disable the WEP Encryption. Data sent to the AP will not be encrypted. To enable WEP encryption for data

	<p>transmission, please choose <b>WEP</b>.</p> <p><b>WEP Keys</b> - Four keys can be entered here, but only one key can be selected at a time. The format of WEP Key is restricted to 5 ASCII characters or 10 hexadecimal values in 64-bit encryption level, or restricted to 13 ASCII characters or 26 hexadecimal values in 128-bit encryption level. The allowed content is the ASCII characters from 33(!) to 126(~) except '#' and ','.</p>
<b>Encryption Type for WPA/PSK and WPA2/PSK</b>	<p>This option is available when WPA/PSK or WPA2/PSK is selected as <b>Security Mode</b>.</p> <p>Select <b>TKIP</b> or <b>AES</b> as the algorithm for WPA.</p>
<b>WEP Keys</b>	<p>Four keys can be entered here, but only one key can be selected at a time. The format of WEP Key is restricted to 5 ASCII characters or 10 hexadecimal values in 64-bit encryption level, or restricted to 13 ASCII characters or 26 hexadecimal values in 128-bit encryption level. The allowed content is the ASCII characters from 33(!) to 126(~) except '#' and ','.</p>
<b>Security Key</b>	<p>Type <b>8~63</b> ASCII characters, such as 012345678..(or 64 Hexadecimal digits leading by 0x, such as "0x321253abcde..."). Such feature is available for <b>WPA/PSK or WPA2/PSK</b> mode.</p>
<b>Use the same SSID and Security Key as above</b>	<p>In general, under the network environment, same SSID and security key can be used for the host (wireless client) and the repeater (VigorAP) in Universal Repeater mode. Check it to use the same SSID and security key configured as above.</p> <p><b>SSID</b> - SSID can be any text numbers or various special characters. For VigorAP is set as "Repeater", the purpose of the device is to extend the Wi-Fi service. Therefore, the characters set here will be regarded as "main SSID". Other wireless client can receive the wireless signal from VigorAP by using the SSID configured here.</p> <p><b>Security</b> - Set <b>8~63</b> ASCII characters or 64 Hexadecimal digits which can be used for logging into VigorAP by other wireless client.</p>
<b>Enable Guest Wireless</b>	<p>Check the box to enable the <b>guest</b> wireless setting.</p> <p><b>SSID</b> – Set a name for VigorAP. Wireless guest is allowed to access into Internet via VigorAP with the SSID configured here.</p> <p><b>Security Key</b> – Set <b>8~63</b> ASCII characters or 64 Hexadecimal digits which can be used for logging into VigorAP by wireless guest.</p> <p><b>Enable Bandwidth Limit</b> – Check the box to define the maximum speed of the data uploading/downloading which will be used for the guest connecting to Vigor device with the same SSID.</p> <ul style="list-style-type: none"> <li>● <b>Upload Limit</b> –Scroll the radio button to choose the value you want.</li> <li>● <b>Download Limit</b> –Scroll the radio button to choose the</li> </ul>

	<p>value you want.</p> <p><b>Enable Station Control</b> – Check the box to set the duration for the guest connecting /reconnecting to Vigor device.</p> <ul style="list-style-type: none"><li>● <b>Connection Time</b> –Scroll the radio button to choose the value you want.</li></ul> <p><b>Reconnection Time</b> –Scroll the radio button to choose the value you want.</p>
--	--

### 2.7.3 Finishing the Wireless Settings Wizard

When you see this page, it means the wireless setting wizard is almost finished. Just click **Finish** to save the settings and complete the setting procedure.

#### Quick Start Wizard

#### Vigor Wizard Setup is now finished!

Basic settings for AP810 is completed.

Press Finish button to save and finish the wizard setup.  
Note that the configuration process takes a few seconds to complete.

## 2.8 Online Status

The online status shows the LAN status, Station Link Status for such device.

### Online Status

System Status				System Uptime: 0d 06:02:42	
<b>LAN-A Status</b>					
<b>IP Address</b>	<b>TX Packets</b>	<b>RX Packets</b>	<b>TX Bytes</b>	<b>RX Bytes</b>	
192.168.1.2	270	196	230309	20594	
<b>LAN-B Status</b>					
<b>IP Address</b>	<b>TX Packets</b>	<b>RX Packets</b>	<b>TX Bytes</b>	<b>RX Bytes</b>	
192.168.2.2	1	0	42	0	
<b>Universal RepeaterStatus</b>					
<b>IP</b>	<b>Gateway</b>	<b>SSID</b>		<b>Channel</b>	
		R1		11	
<b>Mac</b>	<b>Security Mode</b>	<b>TX Packets</b>		<b>RX Packets</b>	
	WPAPSK	65		14	

Detailed explanation is shown below:

Item	Description
<b>IP Address</b>	Displays the IP address of the LAN interface.
<b>TX Packets</b>	Displays the total transmitted packets at the LAN interface.
<b>RX Packets</b>	Displays the total number of received packets at the LAN interface.
<b>TX Bytes</b>	Displays the total transmitted size at the LAN interface.
<b>RX Bytes</b>	Displays the total number of received size at the LAN interface.

# 3

## Advanced Configuration

This chapter will guide users to execute advanced (full) configuration.

1. Open a web browser on your PC and type **http://192.168.1.2**. The window will ask for typing username and password.
2. Please type “admin/admin” on Username/Password for administration operation.

Now, the **Main Screen** will appear. Be aware that “Admin mode” will be displayed on the bottom left side.

The screenshot displays the DrayTek VigorAP 810 web interface. The top header shows the DrayTek logo and the device name 'VigorAP 810'. On the left, there is a navigation menu with options like 'Quick Start Wizard', 'Online Status', 'Operation Mode', 'LAN', 'Central AP Management', 'Wireless LAN', 'RADIUS Setting', 'Objects Setting', 'Applications', 'Mobile Device Management', 'System Maintenance', 'Diagnostics', 'Support Area', 'Knowledge Base', and 'Product Registration'. The main content area is titled 'System Status' and contains the following information:

**System Status**

Model : VigorAP810  
Device Name : VigorAP810  
Firmware Version : 1.3.4  
Build Date/Time : g961\_24e742 Thu Sep 9 17:30:01 CST 2021  
System Uptime : 0d 00:04:35  
Operation Mode : AP

System	
Memory Total	: 62320 kB
Memory Left	: 23864 kB
Cached Memory	: 23936 kB / 62320 kB

LAN-A	
MAC Address	: 00:1D:AA:0F:2E:68
IP Address	: 192.168.1.12
IP Mask	: 255.255.255.0

Wireless	
MAC Address	: 00:1D:AA:0F:2E:68
SSID	: SSID1
Channel	: 11
Driver Version	: 2.7.2.0

LAN-B	
MAC Address	: 00:1D:AA:0F:2E:68
IP Address	: 192.168.2.2
IP Mask	: 255.255.255.0

**WARNING: Your AP is still set to default password. You should change it via System Maintenance menu.**

At the bottom left, it indicates 'Admin mode' and 'AP Mode'.

## 3.1 Operation Mode

This page provides several available modes for you to choose for different conditions. Click any one of them and click **OK**. The system will configure the required settings automatically.

### Operation Mode Configuration

#### Wireless LAN (2.4GHz)

- AP :**  
VigorAP acts as a bridge between wireless devices and wired Ethernet network, and exchanges data between them.
- Station-Infrastructure :**  
Enable the Ethernet device as a wireless station and join a wireless network through an AP.
- AP Bridge-Point to Point :**  
VigorAP will connect to another VigorAP which uses the same mode, and all wired Ethernet clients of both VigorAPs will be connected together.
- AP Bridge-Point to Multi-Point :**  
VigorAP will connect to up to four VigorAPs which uses the same mode, and all wired Ethernet clients of every VigorAPs will be connected together.
- AP Bridge-WDS :**  
VigorAP will connect to up to four VigorAPs which uses the same mode, and all wired Ethernet clients of every VigorAPs will be connected together.  
This mode is still able to accept wireless clients.
- Universal Repeater :**  
VigorAP can act as a wireless repeater; it can be Station and AP at the same time.

OK

Available settings are explained as follows:

Item	Description
<b>AP</b>	This mode allows wireless clients to connect to access point and exchange data with the devices connected to the wired network.
<b>Station-Infrastructure</b>	Enable the Ethernet device such as TV and Game player connected to the VigorAP 810 to an access point.
<b>AP Bridge-Point to Point</b>	This mode can establish wireless connection with another VigorAP 810 using the same mode, and link the wired network which these two VigorAP 810s connected together. Only one access point can be connected in this mode.
<b>AP Bridge-Point to Multi-Point</b>	This mode can establish wireless connection with other VigorAP 810s using the same mode, and link the wired network which these VigorAP 810s connected together. Up to 4 access points can be connected in this mode.
<b>AP Bridge-WDS</b>	This mode is similar to AP Bridge to Multi-Point, but access point is not work in bridge-dedicated mode, and will be able to accept wireless clients while the access point is working as a wireless bridge.
<b>Universal Repeater</b>	This product can act as a wireless range extender that will help you to extend the networking wirelessly. The access point can act as Station and AP at the same time. It can use Station function to connect to a Root AP and use AP function to service



all wireless clients within its coverage.

**Note:** The **Wireless LAN** settings will be changed according to the **Operation Mode** selected here. For the detailed information, please refer to the section of **Wireless LAN**.

## 3.2 LAN

Local Area Network (LAN) is a group of subnets regulated and ruled by modem.



### 3.2.1 General Setup

Click **LAN** to open the LAN settings page and choose **General Setup**.

**Note:** Such page will be changed according to the **Operation Mode** selected. The following screen is obtained by choosing **AP** as the operation mode.

LAN >> General Setup

#### Ethernet TCP / IP and DHCP Setup

<b>LAN-A IP Network Configuration</b> <input checked="" type="checkbox"/> Enable DHCP Client IP Address: <input type="text" value="192.168.1.2"/> Subnet Mask: <input type="text" value="255.255.255.0"/> Default Gateway: <input type="text"/>  <input type="checkbox"/> Enable Management VLAN VLAN ID: <input type="text" value="0"/>	<b>DHCP Server Configuration</b> <input checked="" type="radio"/> Enable Server <input type="radio"/> Disable Server <input type="radio"/> Relay Agent  For DHCP Client Start IP Address: <input type="text"/> End IP Address: <input type="text"/> Subnet Mask: <input type="text"/> Default Gateway: <input type="text"/> Lease Time: <input type="text" value="86400"/> Primary DNS Server: <input type="text"/> Secondary DNS Server: <input type="text"/>
<b>LAN-B IP Network Configuration</b> <input type="checkbox"/> Enable DHCP Client IP Address: <input type="text" value="192.168.2.2"/> Subnet Mask: <input type="text" value="255.255.255.0"/>  <input type="checkbox"/> Enable Management VLAN VLAN ID: <input type="text" value="0"/>	<b>DHCP Server Configuration</b> <input type="radio"/> Enable Server <input checked="" type="radio"/> Disable Server <input type="radio"/> Relay Agent WLAN Trusted DHCP Server: <input type="text" value="Server IP Address"/>
<b>DNS Server IP Address</b> Primary IP Address: <input type="text"/> Secondary IP Address: <input type="text"/>	

OK

Cancel

Available settings are explained as follows:

Item	Description
LAN-A IP Network	<b>Enable DHCP Client</b> – When it is enabled, VigorAP will be treated as a client and can be managed / controlled by AP

<b>Configuration</b>	<p>Management server offered by Vigor router (e.g., Vigor2862).</p> <p><b>IP Address</b> – Type in private IP address for connecting to a local private network (Default: 192.168.1.2).</p> <p><b>Subnet Mask</b> – Type in an address code that determines the size of the network. (Default: 255.255.255.0/ 24)</p> <p><b>Default Gateway</b> – In general, it is not really necessary to specify a gateway for VigorAP. However, if it is required, simply type an IP address as the gateway for VigorAP. It will be convenient for the access point to acquire more service (e.g., accessing NTP server) from Vigor router.</p> <p><b>Enable Management VLAN</b> – VigorAP supports tag-based VLAN for wireless clients accessing Vigor device. Only the clients with the specified VLAN ID can access into VigorAP.</p> <p><b>VLAN ID</b> – Type the number as VLAN ID tagged on the transmitted packet. “0” means no VALN tag.</p>
<b>LAN-B IP Network Configuration</b>	<p><b>Enable DHCP Client</b> – When it is enabled, VigorAP will be treated as a client and can be managed / controlled by AP Management server offered by Vigor router (e.g., Vigor2862).</p> <p><b>IP Address</b> – Type in private IP address for connecting to a local private network (Default: 192.168.2.2).</p> <p><b>Subnet Mask</b> – Type in an address code that determines the size of the network. (Default: 255.255.255.0/ 24)</p> <p><b>Enable Management VLAN</b> – VigorAP 902 supports tag-based VLAN for wireless clients accessing Vigor device. Only the clients with the specified VLAN ID can access into VigorAP.</p> <p><b>VLAN ID</b> – Type the number as VLAN ID tagged on the transmitted packet. “0” means no VALN tag.</p>
<b>DHCP Server Configuration</b>	<p>DHCP stands for Dynamic Host Configuration Protocol. DHCP server can automatically dispatch related IP settings to any local user configured as a DHCP client.</p> <p><b>Enable Server</b> - Enable Server lets the modem assign IP address to every host in the LAN.</p> <ul style="list-style-type: none"> <li>● <b>Start IP Address</b> - Enter a value of the IP address pool for the DHCP server to start with when issuing IP addresses. If the 1st IP address of your modem is 192.168.1.2, the starting IP address must be 192.168.1.3 or greater, but smaller than 192.168.1.254.</li> <li>● <b>End IP Address</b> - Enter a value of the IP address pool for the DHCP server to end with when issuing IP addresses.</li> <li>● <b>Subnet Mask</b> - Type in an address code that determines the size of the network. (Default: 255.255.255.0/ 24)</li> <li>● <b>Default Gateway</b> - Enter a value of the gateway IP address for the DHCP server.</li> <li>● <b>Lease Time</b> - It allows you to set the leased time for the specified PC.</li> </ul>

	<ul style="list-style-type: none"> <li>● <b>Primary DNS Server</b> - You must specify a DNS server IP address here because your ISP should provide you with usually more than one DNS Server. If your ISP does not provide it, the modem will automatically apply default DNS Server IP address: 194.109.6.66 to this field.</li> <li>● <b>Secondary DNS Server</b> - You can specify secondary DNS server IP address here because your ISP often provides you more than one DNS Server. If your ISP does not provide it, the modem will automatically apply default secondary DNS Server IP address: 194.98.0.1 to this field.</li> </ul> <p><b>Relay Agent</b> - Specify which subnet that DHCP server is located the relay agent should redirect the DHCP request to.</p> <ul style="list-style-type: none"> <li>● <b>DHCP Relay Agent</b> - It is available when Enable Relay Agent is selected. Set the IP address of the DHCP server you are going to use so the Relay Agent can help to forward the DHCP request to the DHCP server.</li> </ul> <p><b>Disable Server</b> - Disable Server lets you manually or use other DHCP server to assign IP address to every host in the LAN.</p> <ul style="list-style-type: none"> <li>● <b>WLAN Trusted DHCP Server</b> –There is no right for such VigorAP to assign IP address for wireless LAN user. However, you can specify another valid DHCP server on other VigorAP to make the wireless LAN client obtaining the IP address from the designated DHCP server.</li> </ul> <p>Specify a DHCP server in such field. All the IP addresses of the devices on LAN of VigorAP will be assigned via such specified server. It is used to avoid IP assignment interference due to multiple DHCP servers in one LAN.</p>
<p><b>DNS Server IP Address</b></p>	<p><b>Primary DNS Server</b> - You must specify a DNS server IP address here because your ISP should provide you with usually more than one DNS Server. If your ISP does not provide it, the modem will automatically apply default DNS Server IP address: 194.109.6.66 to this field.</p> <p><b>Secondary DNS Server</b> - You can specify secondary DNS server IP address here because your ISP often provides you more than one DNS Server. If your ISP does not provide it, the modem will automatically apply default secondary DNS Server IP address: 194.98.0.1 to this field.</p>

After finishing this web page configuration, please click **OK** to save the settings.

### 3.2.2 Web Portal

This page allows you to configure a profile with specified URL for accessing into or display a message when a wireless/LAN user connects to Internet through this router. No matter what the purpose of the wireless/LAN client is, he/she will be forced into the URL configured here while trying to access into the Internet or the desired web page through this router. That is, a company which wants to have an advertisement for its products to users can specify the URL in this page to reach its goal.

LAN >> Web Portal

Web Portal Profile:

Index	Enable	Comments	Login Mode	Applied Interface	
1	<input type="checkbox"/>		None		Preview
2	<input type="checkbox"/>		None		Preview
3	<input type="checkbox"/>		None		Preview
4	<input type="checkbox"/>		None		Preview

Note: AP must connect to the Internet otherwise Web Page redirection won't work.

OK Cancel

Each item is explained as follows:

Item	Description
Index	Display the number link which allows you to configure the profile.
Enable	Check the box to enable such profile.
Comments	Display the content (Disable, URL Redirect or Message) of the profile.
Login Mode	Display the login mode that a client uses to access into Internet.
Applied Interface	Display the applied interfaces of the profile.
Preview	Open a preview window according to the configured settings.

After finishing this web page configuration, please click **OK** to save the settings.

To configure the profile, click any index number link to open the following page.

LAN >> Web Portal

Web Portal

<input checked="" type="checkbox"/> Enable	
Comments	<input type="text"/>
Welcome message	<input type="text" value="Welcome!&lt;br/&gt;We are pleased to provide free Wi-Fi to you!"/> <input type="button" value="Default"/> (Max 1024 characters)
Redirect Page	<input checked="" type="radio"/> None <input type="radio"/> URL: <input type="text"/>
Authentication	<input checked="" type="radio"/> None <input type="radio"/> Button Click
Applied Interfaces	LAN <input type="checkbox"/> LAN (Works on Universal Repeater mode) WLAN <input type="checkbox"/> SSID1 (DrayTek-LAN-A) <input type="checkbox"/> SSID2 (DrayTek-LAN-B) <input type="checkbox"/> SSID3 <input type="checkbox"/> SSID4

Note: AP must connect to the Internet otherwise Web Page redirection won't work.

Available settings are explained as follows:

Item	Description
<b>Enable</b>	Check the box to enable this function.
<b>Comments</b>	Enter a brief comment to explain such web portal profile.
<b>Welcome message</b>	Enter words or sentences here. The message will be displayed on the screen for several seconds when the wireless users access into the web page through the router. <ul style="list-style-type: none"> <li>● <b>Default</b> – Click it to restore the default content.</li> </ul>
<b>Redirect Page</b>	<b>None</b> - User can access into Internet directly. <b>URL Redirect</b> - Any user who wants to access into Internet through this router will be redirected to the URL specified here first. It is a useful method for the purpose of advertisement. For example, force the wireless user(s) in hotel to access into the web page that the hotel wants the user(s) to visit.
<b>Authentication</b>	<b>None</b> – User can access into Internet directly without authentication. <b>Button Click</b> – When a client tries to access into Internet, a welcome message page with a button named “Accept” will appear on the screen first. The client must click that button (Accept) and then he/she is allowed to access Internet.
<b>Applied Interfaces</b>	Check the box(es) representing different interfaces to be applied by such profile. <ul style="list-style-type: none"> <li>● <b>LAN</b> – If it is selected and Universal Repeater is specified as connection mode for such AP, both LAN client and WLAN client can access into Internet via web portal. Yet,</li> </ul>

---

	<p>if AP mode is selected, only wireless LAN client shall access into Internet via web portal.</p> <ul style="list-style-type: none"><li>● <b>WLAN</b> - The advantage is that each SSID (1/2/3/4) for wireless network can be applied with different web portal separately.</li></ul>
--	--

---

After finishing all the settings here, please click **OK** to save the configuration.

### 3.3 Central AP Management

Central AP Management allows you to configure VigorAP 810 to be managed by Vigor2862 series.

**WLAN Setting**

SSID: S501, S502, S503, S504, 2.4G SSID

Active:  Enable  Disable

SSID: Draytek-LAN-A [LAN-A] [Hide SSID]

VLAN: 0 (VLAN)

Include:  Non Member

Security Settings

WPA-WPA2-PSK

set up **802.1X** Service if 802.1X is enabled.

WPA:  TKIP  AES  TKIP/AES

Pass Phrase: [ ]

Key Renewal Interval: 3600 Seconds

PMK Cache Period: 30 Minutes

Pre-Authentication:  Enable  Disable

WEP:  Setup WEP Key if WEP is enabled.  802.1X WEP  Enable  Disable

**AP Status**

Index	Device Name	IP Address	SSID	Ch.	Encryption	WL Clients	Firmware	Password
1	AP800-1A2B3C	192.168.254.253	Draytek-pp	Auto(ch13)	802.1x(WPA/WPA2)	10/64	1.1.01	Password
2	AP800-5F	192.168.254.230	Draytek-hw	ch13	WPA2-AES	---	1.1.0	Password
3	AP800-1F2A	192.168.254.112	Draytek-1234567	ch6	None	2/64	1.1.0	Password

Note: Green: Online Red: Offline Gray: Hidden SSID

**LAN**

**Central AP Management**

- General Setup
- APM Log
- Overload Management
- Status of Settings

Wireless LAN

#### 3.3.1 General Setup

Central AP Management >> General Setup

Vigor AP Management

- Enable AP Management
- Enable Auto Provision

Note: LAN-B cannot support APM feature.

OK Cancel

Available settings are explained as follows:

Item	Description
<b>Enable AP Management</b>	Check the box to enable the function of AP Management.
<b>Enable Auto Provision</b>	VigorAP can be controlled under Central AP Management in Vigor router. When both Vigor router and VigorAP have such feature enabled, once VigorAP is registered to Vigor router, the <b>WLAN profile</b> pre-configured on Vigor router will be applied to VigorAP immediately. Thus, it is not necessary to configure VigorAP separately.

### 3.3.2 APM Log

This page will display log information related to wireless stations connected to VigorAP and central AP management.

Such information also will be delivered to Vigor router (e.g., Vigor2862 series) and be shown on **Central AP Management>>APM Log** of Vigor router.

Central AP Management >> APM Log

APM Log Information

| [Clear](#) | [Refresh](#) |  Line wrap |

```
0d 00:31:52 syslog: [APM] Get the 'Query AP status' Request.
0d 00:32:53 syslog: [APM] Get the 'Query AP status' Request.
0d 00:33:53 syslog: [APM] Get the 'Query AP status' Request.
0d 00:34:53 syslog: [APM] Get the 'Query AP status' Request.
0d 00:35:53 syslog: [APM] Get the 'Query AP status' Request.
0d 00:36:53 syslog: [APM] Get the 'Query AP status' Request.
0d 00:37:53 syslog: [APM] Get the 'Query AP status' Request.
0d 00:38:54 syslog: [APM] Get the 'Query AP status' Request.
0d 00:39:54 syslog: [APM] Get the 'Query AP status' Request.
0d 00:40:54 syslog: [APM] Get the 'Query AP status' Request.
```

### 3.3.3 Overload Management

Load Balance can help to distribute the traffic for all of the access points (e.g., VigorAP) registered to Vigor router. Thus, the bandwidth will not be occupied by certain access points.

However, traffic overload might be occurred if too many wireless stations connected to VigorAP for data incoming and outgoing. Therefore, “Force Overload Disassociation” is required to terminate the network connection of the client’s station to release network traffic. When the function of “Force Overload Disassociation” in web user interface of Vigor router (e.g., Vigor2862) is enabled, wireless clients specified in **black list** of such web page will be disassociated to solve the problem of traffic overload.

The following web page is used to configure white list and black list for wireless stations.



Overload Management

**MAC Address Filter of Force Overload Disassociation**

Index	MAC Address	Comment
<b>White List</b>		
<b>Black List</b>		

Client's MAC Address :  :  :  :  :  :

Apply to : White List ▼

Comment :

**Note:** When force overload disassociation is enabled, clients in black list will be disassociated first. Clients in white list will not be disassociated.

Available settings are explained as follows:

Item	Description
<b>White List/Black List</b>	Display the information (such as index number, MAC address and comment) for all of the members in White List/Black List.  Wireless stations listed in Black List will be forcefully disconnected first when traffic overload occurs and “Force Overload Disassociation” is enabled.
<b>Client’s MAC Address</b>	Specify the MAC Address of the remote/local client.
<b>Apply to</b>	<b>White List</b> – MAC address listed inside Client’s MAC Address will be categorized as one of members in White List.  <b>Black List</b> - MAC address listed inside Client’s MAC Address will be categorized as one of members in Black List.
<b>Comment</b>	Type any words as notification.
<b>Add</b>	Add a new MAC address into the White List/Black List.
<b>Delete</b>	Delete the selected MAC address in the White List/Black List.
<b>Edit</b>	Edit the selected MAC address in the White List/Black List.
<b>Cancel</b>	Give up the configuration.

### 3.3.4 Status of Settings

Load Balance can help to distribute the traffic for all of the access points (e.g., VigorAP) registered to Vigor router. This web page displays the settings related to Load Balance for VigorAP. In which, Station Number Threshold, Traffic Threshold and Force Overload Disassociation indicate settings configured in Vigor router.

Central AP Management >> Status of Settings

Function Name	Status	Value
<b>Load Balance</b>		
Station Number Threshold	✓	
Max WLAN(2.4GHz) Station Number		15
Traffic Threshold	✗	
Upload Limit		None bps
Download Limit		None bps
Force Overload Disassociation	✗	
Disassociate By		None
RSSI Threshold		-50 dBm
<b>Rogue AP Detection</b>		
Rogue AP Detection	✗	

Below shows a setting example for Load Balance settings configured in Vigor router.

Central Management >> AP >> Load Balance

**AP Load Balance** By Station Number or Traffic ▼

**Station Number Threshold**

---

Wireless LAN (2.4GHz)  (3-128)  
 Wireless LAN (5GHz)  (3-128)  
 Wireless LAN (5GHz-2)  (3-128)

**Traffic Threshold**

---

Upload Limit User defined ▼  bps (Default unit: K)  
 Download Limit User defined ▼  bps (Default unit: K)

**Action When Threshold Exceeded**

---

Stop accepting new connections  
 Dissociate existing station by longest idle time  
 Dissociate existing station by worst signal strength if it is less than  dBm ( %)

**Choose to Apply**

---

All APs ▼  
All APs  
Specific APs

**Note:** The maximum station number of Wireless LAN (2.4GHz) will be applied to both Wireless LAN (2.4GHz) and Wireless LAN (5GHz) if the firmware version of AP900 is less than or equal to 1.1.4.1.

### 3.4 General Concepts for Wireless LAN

The VigorAP 810 is equipped with a wireless LAN interface compliant with the standard IEEE 802.11n draft 2 protocol. To boost its performance further, the VigorAP 810 is also loaded with advanced wireless technology to lift up data rate up to 300 Mbps\*. Hence, you can finally smoothly enjoy stream music and video.

**Note:** \* The actual data throughput will vary according to the network conditions and environmental factors, including volume of network traffic, network overhead and building materials.

In an Infrastructure Mode of wireless network, VigorAP 810 plays a role as an Access Point (AP) connecting to lots of wireless clients or Stations (STA). All the STAs will share the same Internet connection via VigorAP 810. The **General Setup** will set up the information of this wireless network, including its SSID as identification, located channel etc.

#### Security Overview

WEP (Wired Equivalent Privacy) is a legacy method to encrypt each frame transmitted via radio using either a 64-bit or 128-bit key. Usually access point will preset a set of four keys and it will communicate with each station using only one out of the four keys.

WPA (Wi-Fi Protected Access), the most dominating security mechanism in industry, is separated into two categories: WPA-personal or called WPA Pre-Share Key (WPA/PSK), and WPA-Enterprise or called WPA/802.1x.

In WPA-Personal, a pre-defined key is used for encryption during data transmission. WPA applies Temporal Key Integrity Protocol (TKIP) for data encryption while WPA2 applies AES. The WPA-Enterprise combines not only encryption but also authentication.

Since WEP has been proved vulnerable, you may consider using WPA for the most secure connection. You should select the appropriate security mechanism according to your needs. No matter which security suite you select, they all will enhance the over-the-air data protection and /or privacy on your wireless network. The VigorAP 810 is very flexible and can support multiple secure connections with both WEP and WPA at the same time.

#### WPS Introduction

**WPS (Wi-Fi Protected Setup)** provides easy procedure to make network connection between wireless station and wireless access point (VigorAP 810) with the encryption of WPA and WPA2.

It is the simplest way to build connection between wireless network clients and VigorAP 810. Users do not need to select any encryption mode and type any long encryption passphrase to setup a wireless client every time. He/she only needs to press a button on wireless client, and WPS will connect for client and VigorAP 810 automatically.



**Note:** Such function is available for the wireless station with WPS supported.

There are two methods to do network connection through WPS between AP and Stations: pressing the **Start PBC** button or using **PIN Code**.

On the side of VigorAP 810 series which served as an AP, press **WPS** button once on the front panel of VigorAP 810 or click **Start PBC** on web configuration interface. On the side of a station with network card installed, press **Start PBC** button of network card.

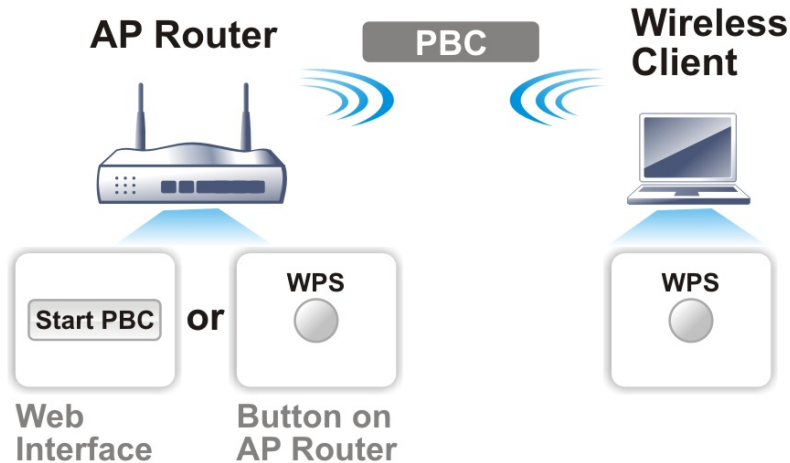

If you want to use PIN code, you have to know the PIN code specified in wireless client. Then provide the PIN code of the wireless client you wish to connect to the VigorAP 810.

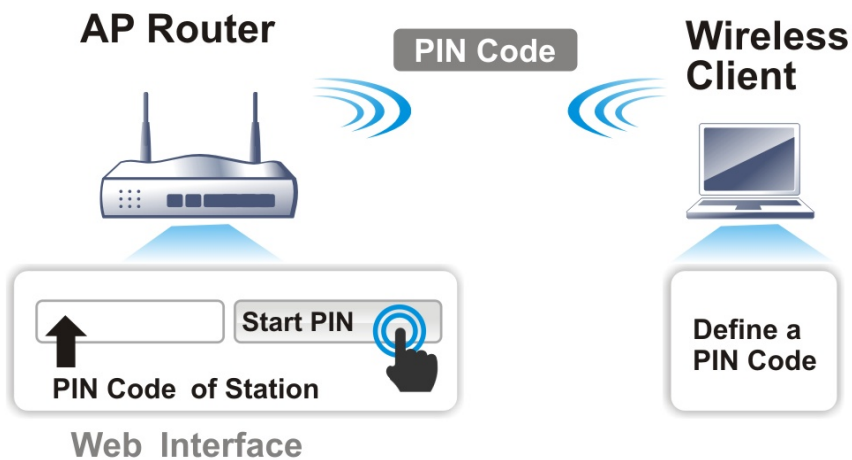

### 3.5 Wireless LAN Settings for AP Mode

When you choose **AP** as the operation mode, the Wireless LAN menu items will include General Setup, Security, Access Control, WPS, Advanced Setting, AP Discovery, Bandwidth Management, Airtime Fairness, Station Control, Roaming, and Station List.

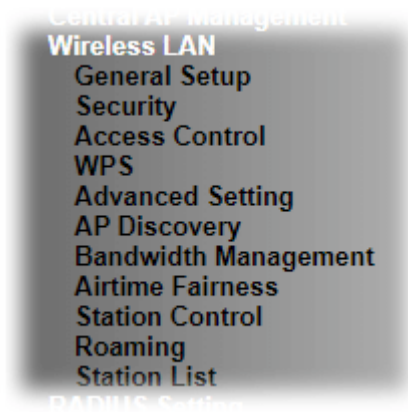

**Note:** The **Wireless LAN** settings will be changed according to the **Operation Mode** selected in section 3.1.

### 3.5.1 General Setup

By clicking the **General Setup**, a new web page will appear so that you could configure the SSID and the wireless channel. Please refer to the following figure for more information.

Wireless LAN >> General Setup

---

General Setting ( IEEE 802.11 )

Enable Wireless LAN

Enable Client Limit  (3 ~ 64, default: 64)

Enable Client Limit per SSID (3 ~ 64, default: 64)

---

Mode :  ▼

Channel :  ▼

Extension Channel :  ▼

---

Enable 2 Subnet (Simulate 2 APs)

	Enable	Hide SSID	SSID	Subnet	Isolate LAN	Isolate Member	VLAN ID (0:Untagged)
1	<input type="checkbox"/>	<input type="checkbox"/>	<input type="text" value="DrayTek-LAN-A"/>	<input type="text" value="LAN-A"/> ▼	<input type="checkbox"/>	<input type="checkbox"/>	<input type="text" value="0"/>
2	<input checked="" type="checkbox"/>	<input type="checkbox"/>	<input type="text" value="DrayTek-LAN-B"/>	<input type="text" value="LAN-B"/> ▼	<input type="checkbox"/>	<input type="checkbox"/>	<input type="text" value="0"/>
3	<input type="checkbox"/>	<input type="checkbox"/>	<input type="text"/>	<input type="text" value="LAN-A"/> ▼	<input type="checkbox"/>	<input type="checkbox"/>	<input type="text" value="0"/>
4	<input type="checkbox"/>	<input type="checkbox"/>	<input type="text"/>	<input type="text" value="LAN-A"/> ▼	<input type="checkbox"/>	<input type="checkbox"/>	<input type="text" value="0"/>

Hide SSID: Prevent SSID from being scanned.  
 Isolate LAN: Wireless clients (stations) with the same SSID cannot access wired PCs on LAN.  
 Isolate Member: Wireless clients (stations) with the same SSID cannot access for each other.  
 Isolate Exception: Isolate Exception can be created by adding the MAC from [Device Object](#).

Available settings are explained as follows:

Item	Description
<b>Enable Wireless LAN</b>	Check the box to enable wireless function.
<b>Enable Client Limit</b>	Check the box to set the maximum number of wireless stations which try to connect Internet through Vigor AP. The number you can set is from 3 to 64.
<b>Enable Client Limit per SSID</b>	Define the maximum number of wireless stations per SSID which try to connect to Internet through Vigor device. The number you can set is from 3 to 64.
<b>Mode</b>	At present, VigorAP 810 can connect to 11b only, 11g only, 11n only, Mixed (11b+11g), Mixed (11g+11n) and Mixed (11b+11g+11n) stations simultaneously. Simply choose Mixed (11b+11g+11n) mode.
<b>Channel</b>	Means the channel of frequency of the wireless LAN. You may switch channel if the selected channel is under serious interference. If you have no idea of choosing the frequency, please select <b>AutoSelect</b> to let system determine for you.
<b>Extension Channel</b>	With 802.11n, there is one option to double the bandwidth per channel. The available extension channel options will be varied according to the <b>Channel</b> selected above. Configure the

	extension channel you want.
<b>Enable 2 Subnet (Simulate 2 APs)</b>	<p>Check the box to enable the function for two independent subnets. Once you enable this function, LAN-A and LAN-B would be independent. Next, you can connect one router in LAN-A, and another router in LAN-B. Such mechanism can make you feeling that you have two independent AP/subnet functions in one VigorAP 810.</p> <p>If you disable this function, LAN-A and LAN-B ports are in the same domain. You could only connect one router (no matter connecting to LAN-A or LAN-B) in this environment.</p>
<b>Enable</b>	SSID #1 is enabled in default. SSID #2 ~ #4 can be enabled manually.
<b>Hide SSID</b>	Check it to prevent from wireless sniffing and make it harder for unauthorized clients or STAs to join your wireless LAN. Depending on the wireless utility, the user may only see the information except SSID or just cannot see any thing about VigorAP 810 while site surveying. The system allows you to set three sets of SSID for different usage.
<b>SSID</b>	Set a name for VigorAP 810 to be identified. Default settings are DrayTek-LAN-A and DrayTek-LAN-B. When <b>Enable 2 Subnet</b> is enabled, you can specify subnet interface (LAN-A or LAN-B) for each SSID by using the drop down menu.
<b>Subnet</b>	Choose LAN-A or LAN-B for each SSID. If you choose LAN-A, the wireless clients connecting to this SSID could only communicate with LAN-A.
<b>Isolate LAN</b>	Check this box to isolate the wireless connection from LAN. It can make the wireless clients (stations) with remote-dial and LAN to LAN users not accessing for each other.
<b>Isolate Member</b>	Check this box to make the wireless clients (stations) with the same SSID not accessing for each other.
<b>VLAN ID</b>	<p>Type the value for such SSID. Packets transferred from such SSID to LAN will be tagged with the number.</p> <p>If your network uses VLANs, you can assign the SSID to a VLAN on your network. Client devices that associate using the SSID are grouped into this VLAN. The VLAN ID range is from 3 to 4095. The VLAN ID is 0 by default, it means disabling the VLAN function for the SSID.</p>

After finishing this web page configuration, please click **OK** to save the settings.

### 3.5.2 Security

This page allows you to set security with different modes for SSID 1, 2, 3 and 4 respectively. After configuring the correct settings, please click **OK** to save and invoke it.

By clicking the **Security Settings**, a new web page will appear so that you could configure the settings.

Wireless LAN >> Security Settings

SSID 1	SSID 2	SSID 3	SSID 4
SSID	DrayTek-LAN-A		
Mode	<div style="border: 1px solid black; padding: 2px;">           WPA2 Personal ▼  <span style="background-color: #007bff; color: white; padding: 2px;">WPA2 Personal</span>            WPA2/WPA Personal            WPA2 Enterprise            WPA2/WPA Enterprise            =====Not Secure=====            WPA Personal            WPA Enterprise            WEP Personal            None         </div>		
Set up <u>RADIUS Server</u> if 802.1x	<input type="checkbox"/>		
<b>WPA</b>			
WPA Algorithms	<input type="checkbox"/> WPA Personal <input type="checkbox"/> WPA Enterprise <input type="checkbox"/> WPA2 Personal/AES		
Pass Phrase	<input type="text"/>		
Key Renewal Interval	<input type="text"/>		
EAPOL Key Retry	<input checked="" type="radio"/> Enable <input type="radio"/> Disable		
<b>WEP</b>			
<input type="radio"/> Key 1 :	<input type="text"/>	<input type="text"/> Hex ▼	
<input checked="" type="radio"/> Key 2 :	<input type="text"/>	<input type="text"/> Hex ▼	
<input type="radio"/> Key 3 :	<input type="text"/>	<input type="text"/> Hex ▼	
<input type="radio"/> Key 4 :	<input type="text"/>	<input type="text"/> Hex ▼	

Available settings are explained as follows:

Item	Description
<b>Mode</b>	<p>There are several modes provided for you to choose.</p> <p><u>Below shows the modes with higher security:</u></p> <p><b>WPA2 Personal, WPA2/WPA Personal</b> - Accepts only WPA clients and the encryption key should be entered in PSK. The WPA encrypts each frame transmitted from the radio using the key, which either PSK (Pre-Shared Key) entered manually in this field below or automatically negotiated via 802.1x authentication.</p> <p>The WPA encrypts each frame transmitted from the radio using the key, which either PSK (Pre-Shared Key) entered manually in this field below or automatically negotiated via 802.1x authentication. Select WPA, WPA2 or Auto as WPA mode.</p> <p><b>WPA2 Enterprise, WPA2/WPA Enterprise</b> - The WPA encrypts each frame transmitted from the radio using the key, which either PSK (Pre-Shared Key) entered manually in this field below or automatically negotiated via 802.1x authentication.</p> <p><u>Below shows the modes with basic security:</u></p> <p><b>WPA Personal</b> - Accepts only WPA clients and the encryption key should be entered in PSK. The WPA encrypts each frame</p>



	<p>transmitted from the radio using the key, which either PSK (Pre-Shared Key) entered manually in this field below or automatically negotiated via 802.1x authentication.</p> <p><b>WPA Enterprise</b> - The WPA encrypts each frame transmitted from the radio using the key, which either PSK (Pre-Shared Key) entered manually in this field below or automatically negotiated via 802.1x authentication.</p> <p><b>WEP Personal</b> - Accepts only WEP clients and the encryption key should be entered in WEP Key.</p> <p><b>None</b> - The encryption mechanism is turned off.</p>
<b>WPA Algorithms</b>	Select TKIP, AES or TKIP/AES as the algorithm for WPA. Such feature is available for <b>WPA2 Enterprise, WPA Enterprise, WPA Personal</b> or <b>WPA2/WPA Personal</b> mode.
<b>Pass Phrase</b>	Either <b>8~63</b> ASCII characters, such as 012345678..(or 64 Hexadecimal digits leading by 0x, such as "0x321253abcde..."). Such feature is available for <b>WPA Personal</b> or <b>WPA2 Personal</b> or <b>WPA2/WPA Personal</b> mode.
<b>Key Renewal Interval</b>	WPA uses shared key for authentication to the network. However, normal network operations use a different encryption key that is randomly generated. This randomly generated key that is periodically replaced. Enter the renewal security time (seconds) in the column. Smaller interval leads to greater security but lower performance. Default is 3600 seconds. Set 0 to disable re-key. Such feature is available for <b>WPA2 Enterprise, WPA Enterprise, WPA Personal</b> or <b>WPA2 Personal</b> or <b>WPA2/WPA Personal</b> mode.
<b>EAPOL Key Retry</b>	EAPOL means Extensible Authentication Protocol over LAN. <b>Enable</b> - The default setting is "Enable". It can make sure that the key will be installed and used once in order to prevent key reinstallation attack.
<b>Key 1 – Key 4</b>	Four keys can be entered here, but only one key can be selected at a time. The format of WEP Key is restricted to 5 ASCII characters or 10 hexadecimal values in 64-bit encryption level, or restricted to 13 ASCII characters or 26 hexadecimal values in 128-bit encryption level. The allowed content is the ASCII characters from 33(!) to 126(~) except '#' and ','. Such feature is available for <b>WEP</b> mode.

Click the link of **RADIUS Server** to access into the following page for more settings.

Available settings are explained as follows:

Item	Description
<b>Use internal RADIUS Server</b>	There is a RADIUS server built in VigorAP 810 which is used to authenticate the wireless client connecting to the access point. Check this box to use the internal RADIUS server for wireless security.  Besides, if you want to use the external RADIUS server for authentication, do not check this box.  Please refer to the section, <b>3.10 RADIUS Setting</b> to configure settings for internal server of VigorAP 810.
<b>IP Address</b>	Enter the IP address of external RADIUS server.
<b>Port</b>	The UDP port number that the external RADIUS server is using. The default value is 1812, based on RFC 2138.
<b>Shared Secret</b>	The external RADIUS server and client share a secret that is used to authenticate the messages sent between them. Both sides must be configured to use the same shared secret.
<b>Session Timeout</b>	Set the maximum time of service provided before re-authentication. Set to zero to perform another authentication immediately after the first authentication has successfully completed. (The unit is second.)

After finishing this web page configuration, please click **OK** to save the settings.

### 3.5.3 Access Control

For additional security of wireless access, the **Access Control** facility allows you to restrict the network access right by controlling the wireless LAN MAC address of client. Only the valid MAC address that has been configured can access the wireless LAN interface. By clicking the **Access Control**, a new web page will appear, as depicted below, so that you could edit the clients' MAC addresses to control their access rights (deny or allow).

SSID 1	SSID 2	SSID 3	SSID 4						
SSID: DrayTek-LAN-A Policy: <input type="text" value="Disable"/>									
<b>MAC Address Filter</b>									
<table border="1"> <thead> <tr> <th>Index</th> <th>MAC Address</th> <th>access comment</th> </tr> </thead> <tbody> <tr> <td colspan="3" style="height: 100px;"> <div style="border: 1px solid gray; width: 100%; height: 100%;"></div> </td> </tr> </tbody> </table>				Index	MAC Address	access comment	<div style="border: 1px solid gray; width: 100%; height: 100%;"></div>		
Index	MAC Address	access comment							
<div style="border: 1px solid gray; width: 100%; height: 100%;"></div>									
<input type="radio"/> MAC <input checked="" type="radio"/> Object									
Device Group <input type="text" value="None"/> or Device Object <input type="text" value="None"/>									
<input type="button" value="Add"/> Limit:256 entries									
<input type="button" value="OK"/> <input type="button" value="Cancel"/>									
Backup ACL Cfg : <input type="button" value="Backup"/>		Upload From File: <input type="button" value="選擇檔案"/> 未選擇任何檔案 <input type="button" value="Restore"/>							

Available settings are explained as follows:

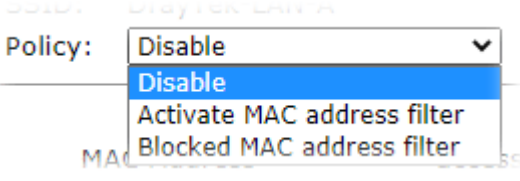
Item	Description
<b>Policy</b>	<p>Select to enable any one of the following policy or disable the policy. Choose <b>Activate MAC address filter</b> to type in the MAC addresses for other clients in the network manually. Choose <b>Blocked MAC address filter</b>, so that all of the devices with the MAC addresses listed on the MAC Address Filter table will be blocked and cannot access into VigorAP 810.</p> 
<b>MAC Address Filter</b>	Display all MAC addresses that are edited before.
<b>MAC</b>	<p><b>Client's MAC Address</b> - Manually enter the MAC address of wireless client.</p> <p><b>Add</b> - Add a new MAC address into the list.</p> <p><b>Delete</b> - Delete the selected MAC address in the list.</p> <p><b>Edit</b> - Edit the selected MAC address in the list.</p>
<b>Object</b>	<p>In addition to enter the MAC address of the device manually, you can</p> <p><b>Device Group</b> - Select one of the existed device groups and click <b>Add</b>. All the devices belonging to the selected group will be shown on the MAC Address Filter table.</p> <p><b>Device Object</b> - Select one of the existed device object and click <b>Add</b>. The MAC address of the device will be shown on the MAC Address Filter table.</p>

<b>Cancel</b>	Give up the access control set up.
<b>Backup</b>	Click it to store the settings (MAC addresses on MAC Address Filter table) on this page as a file.
<b>Restore</b>	Click it to restore the settings (MAC addresses on MAC Address Filter table) from an existed file.

After finishing this web page configuration, please click **OK** to save the settings.

### 3.5.4 WPS

Open **Wireless LAN>>WPS** to configure the corresponding settings.

Wireless LAN >> WPS (Wi-Fi Protected Setup)

Enable WPS 

Wi-Fi Protected Setup Information

WPS Configured	Yes
WPS SSID	DrayTek-LAN-A
WPS Auth Mode	WPA2 Personal
WPS Encrypt Type	AES

Device Configure

Configure via Push Button	<input type="button" value="Start PBC"/>
Configure via Client PinCode	<input type="text"/> <input type="button" value="Start PIN"/>

Status: Not used

**Note:** WPS can help your wireless client automatically connect to the Access point.

: WPS is Disabled.

: WPS is Enabled.

: Waiting for WPS requests from wireless clients.

Available settings are explained as follows:

Item	Description
<b>Enable WPS</b>	Check this box to enable WPS setting.
<b>WPS Configured</b>	Display related system information for WPS. If the wireless security (encryption) function of VigorAP 810 is properly configured, you can see 'Yes' message here.
<b>WPS SSID</b>	Display current selected SSID.
<b>WPS Auth Mode</b>	Display current authentication mode of the VigorAP 810. Only WPA2 Personal and WPA Personal support WPS.
<b>WPS Encrypt Type</b>	Display encryption mode (None, WEP, TKIP, AES, etc.) of VigorAP 810.
<b>Configure via Push Button</b>	Click <b>Start PBC</b> to invoke Push-Button style WPS setup procedure. VigorAP 810 will wait for WPS requests from wireless clients about two minutes. The WPS LED on VigorAP 810 will blink fast when WPS is in progress. It will return to normal condition after two minutes. (You need to setup WPS within two minutes)
<b>Configure via Client</b>	Type the PIN code specified in wireless client you wish to connect, and click <b>Start PIN</b> button. The WLAN LED on

<b>PinCode</b>	VigorAP 810 will blink fast when WPS is in progress. It will return to normal condition after two minutes. (You need to setup WPS within two minutes).
----------------	--

### 3.5.5 Advanced Setting

This page is to determine which algorithm will be selected for wireless transmission rate.

Wireless LAN >> Advanced Setting

Channel Bandwidth	<input type="radio"/> 20 MHz <input checked="" type="radio"/> Auto 20/40 MHz <input type="radio"/> 40 MHz
Packet-OVERDRIVE™ Tx Burst	<input type="radio"/> Enable <input checked="" type="radio"/> Disable (For 11g mode only)
Antenna	<input checked="" type="radio"/> 2T2R <input type="radio"/> 1T1R (1T1R would use the right antenna)
Tx Power	<input checked="" type="radio"/> 100% <input type="radio"/> 80% <input type="radio"/> 60% <input type="radio"/> 30% <input type="radio"/> 20% <input type="radio"/> 10%
Rate Adaptation Algorithm	<input checked="" type="radio"/> New <input type="radio"/> Old
Fragment Length (256 - 2346)	<input type="text" value="2346"/> bytes
RTS Threshold (1 - 2347)	<input type="text" value="2347"/> bytes
Country Code	<input type="text"/> (Reference)
Auto Channel Filtered Out List	<input type="checkbox"/> 1 <input type="checkbox"/> 2 <input type="checkbox"/> 3 <input type="checkbox"/> 4 <input type="checkbox"/> 5 <input type="checkbox"/> 6 <input type="checkbox"/> 7 <input type="checkbox"/> 8 <input type="checkbox"/> 9 <input type="checkbox"/> 10 <input type="checkbox"/> 11 <input type="checkbox"/> 12 <input type="checkbox"/> 13
IGMP Snooping	<input checked="" type="radio"/> Enable <input type="radio"/> Disable
WMM Capable	<input type="radio"/> Enable <input checked="" type="radio"/> Disable
MAC Clone	<input type="radio"/> Enable <input checked="" type="radio"/> Disable <input type="text"/>
<b>MAC Clone:</b>	Set the MAC address of SSIDs and the Wireless client. Please notice that the last byte of this MAC address must be a multiple of 8.

Available settings are explained as follows:

Item	Description
<b>Channel Bandwidth</b>	<p><b>20 MHZ-</b> the AP will use 20MHz for data transmission and receiving between the AP and the stations.</p> <p><b>Auto 20/40 MHZ-</b> the AP will scan for nearby wireless AP, and then use 20MHz if the number of AP is more than 10, or use 40MHz if it's not.</p> <p><b>40 MHZ-</b> the AP will use 40MHz for data transmission and receiving between the AP and the stations.</p>
<b>Packet-OVERDRIVE</b>	<p>This feature can enhance the performance in data transmission about 40%* more (by checking <b>Tx Burst</b>). It is active only when both sides of Access Point and Station (in wireless client) invoke this function at the same time. That is, the wireless client must support this feature and invoke the function, too.</p> <p><b>Note:</b> Vigor N61 wireless adapter supports this function. Therefore, you can use and install it into your PC for matching with Packet-OVERDRIVE (refer to the following picture of Vigor N61 wireless utility window, choose <b>Enable</b> for <b>TxBURST</b> on the tab of <b>Option</b>).</p>

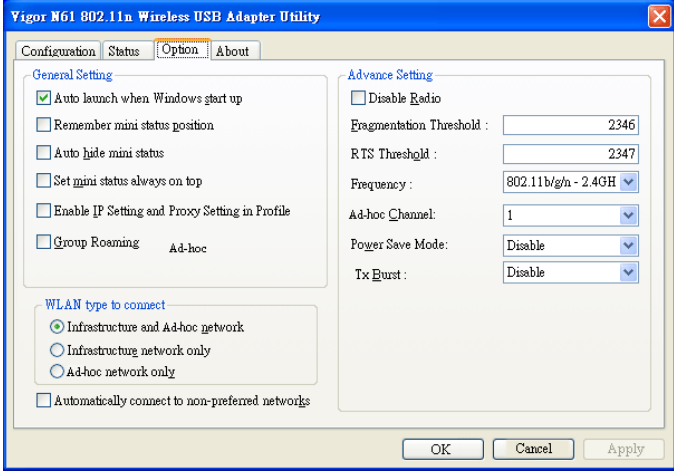
	
<b>Antenna</b>	VigorAP can be attached with two antennas to have good data transmission via wireless connection. However, if you have only one antenna attached, please choose 1T1R.
<b>Tx Power</b>	The default setting is the maximum (100%). Lowering down the value may degrade range and throughput of wireless.
<b>Rate Adaptation Algorithm</b>	Wireless transmission rate is adapted dynamically. Usually, performance of “new” algorithm is better than “old”.
<b>Fragment Length</b>	Set the Fragment threshold of wireless radio. Do not modify default value if you don’t know what it is, default value is 2346.
<b>RTS Threshold</b>	Minimize the collision (unit is bytes) between hidden stations to improve wireless performance. Set the RTS threshold of wireless radio. Do not modify default value if you don’t know what it is, default value is 2347.
<b>Country Code</b>	VigorAP broadcasts country codes by following the 802.11d standard. However, some wireless stations will detect / scan the country code to prevent conflict occurred. If conflict is detected, wireless station will be warned and is unable to make network connection. Therefore, changing the country code to ensure successful network connection will be necessary for some clients.
<b>Auto Channel Filtered Out List</b>	The selected wireless channels will be discarded if <b>AutoSelect</b> is selected as <b>Channel</b> selection mode in <b>Wireless LAN&gt;&gt;General Setup</b> .
<b>IGMP Snooping</b>	Check <b>Enable</b> to enable IGMP Snooping. Multicast traffic will be forwarded to ports that have members of that group. Disabling IGMP snooping will make multicast traffic treated in the same manner as broadcast traffic.
<b>WMM Capable</b>	To apply WMM parameters for wireless data transmission, please click the <b>Enable</b> radio button.
<b>MAC Clone</b>	Click <b>Enable</b> and manually enter the MAC address of the device with SSID 1. The MAC address of other SSIDs will change based on this MAC address.

After finishing this web page configuration, please click **OK** to save the settings.

### 3.5.6 AP Discovery

VigorAP 810 can scan all regulatory channels and find working APs in the neighborhood. Based on the scanning result, users will know which channel is clean for usage. Also, it can be used to facilitate finding an AP for a WDS link. Notice that during the scanning process (about 5 seconds), no client is allowed to connect to Vigor.

This page is used to scan the existence of the APs on the wireless LAN. Please click **Scan** to discover all the connected APs.

Wireless LAN >> Access Point Discovery

#### Access Point List

Enable AP Monitor Mode

Index	SSID	BSSID	RSSI	Channel	Encryption	Authentication	Mode	Ch. Width
1	staffs	00:1d:aa:9c:fb:28	5%	1	TKIP/AES	Mixed(WPA+WPA2)/PSK	11b/g/n	20
2	staffs_SF_...	00:1d:aa:f8:c9:c8	91%	1	TKIP/AES	Mixed(WPA+WPA2)/PSK	11b/g/n	20
3	guests_v29...	02:1d:aa:f8:c9:c8	91%	1	TKIP/AES	Mixed(WPA+WPA2)/PSK	11b/g/n	20
4	staffs_v29...	02:1d:aa:f9:c9:c8	91%	1	TKIP/AES	Mixed(WPA+WPA2)/PSK	11b/g/n	20
5	GRX350_24G...	00:e0:92:00:01:50	15%	1	AES	WPA2/PSK	11b/g/n	20
6	MVE	02:1d:aa:dd:74:e0	5%	3	TKIP/AES	Mixed(WPA+WPA2)/PSK	11b/g/n	20
7	VFNL-E486C...	00:1d:aa:2a:5b:70	24%	6	TKIP/AES	WPA2/PSK	11b/g/n	40
8	guests	06:1d:aa:9c:f6:44	86%	6	TKIP/AES	Mixed(WPA+WPA2)/PSK	11b/g/n	20
9	staffs_4F	00:1d:aa:9d:68:ac	34%	8	TKIP/AES	Mixed(WPA+WPA2)/PSK	11b/g/n	40
10	staffs	02:1d:aa:9d:68:ac	34%	8	TKIP/AES	Mixed(WPA+WPA2)/PSK	11b/g/n	40
11	guests	0a:1d:aa:9d:68:ac	34%	8	TKIP/AES	Mixed(WPA+WPA2)/PSK	11b/g/n	40
12	PQC APM Te...	00:50:7f:fd:d5:c0	5%	9	WEP		11b	20
13	Vigor2860-...	00:1d:aa:9d:20:0c	76%	11	AES	WPA2/PSK	11b/g/n	20
14	Vigor2862-...	ff:ff:ff:66:77:64	34%	11	TKIP/AES	Mixed(WPA+WPA2)/PSK	11b/g/n	20
15	Vigor2862-...	00:1d:aa:9e:2b:38	39%	11	TKIP/AES	Mixed(WPA+WPA2)/PSK	11b/g/n	20
16	DrayTek	00:1d:aa:74:da:38	0%	11	TKIP/AES	Mixed(WPA+WPA2)/PSK	11b/g/n	20
17	RD8_ACS_TE...	00:1d:aa:f7:a9:00	29%	11	TKIP/AES	Mixed(WPA+WPA2)/PSK	11b/g/n	20
18	DrayTek-LA...	00:1d:aa:19:63:a0	15%	11	WEP		11b/g/n	20
19	DrayTek-LA...	02:1d:aa:18:63:a0	20%	11	TKIP/AES	Mixed(WPA+WPA2)/PSK	11b/g/n	20

Scan

See [Channel Interference](#)

**Note:** During the scanning process (about 5 seconds), no station is allowed to connect with the AP.

Each item is explained as follows:

Item	Description
<b>Enable AP Monitor Mode</b>	This function can help to get and keep the records of APs detected by such device after clicking Scan.  In general, only the available AP will be detected by Vigor device. Once the AP is unavailable, it will be deleted from the Access Point List immediately. However, if such function is enabled, the system will keep the record of the AP (once detected by Vigor device) until it is available for Vigor device again.
<b>SSID</b>	Display the SSID of the AP scanned by VigorAP 810.
<b>BSSID</b>	Display the MAC address of the AP scanned by VigorAP 810.
<b>RSSI</b>	Display the signal strength of the access point. RSSI is the abbreviation of Receive Signal Strength Indication.
<b>Channel</b>	Display the wireless channel used for the AP that is scanned by VigorAP 810.
<b>Encryption</b>	Display the encryption mode for the scanned AP.
<b>Authentication</b>	Display the authentication type that the scanned AP applied.
<b>Mode</b>	Display the wireless connection mode that the scanned AP used.
<b>Ch. Width</b>	Display the channel width that the scanned AP used.

<b>Scan</b>	It is used to discover all the connected AP. The results will be shown on the box above this button
<b>Channel Statistics</b>	It displays the statistics for the channels used by APs.



### 3.5.7 Bandwidth Management

The downstream or upstream from FTP, HTTP or some P2P applications will occupy large of bandwidth and affect the applications for other programs. Please use Bandwidth Management to make the bandwidth usage more efficient.

Wireless LAN >> Bandwidth Management

SSID 1	SSID 2	SSID 3	SSID 4
SSID DrayTek-LAN-A			
Per Station Bandwidth Limit			
Enable	<input checked="" type="checkbox"/>		
Upload Limit	User defined	K	bps (Default unit : K)
Download Limit	User defined	K	bps (Default unit : K)
Auto Adjustment	<input checked="" type="checkbox"/>		
Total Upload Limit	User defined	K	bps (Default unit : K)
Total Download Limit	User defined	K	bps (Default unit : K)

**Note:** 1. Download : Traffic going to any station. Upload : Traffic being sent from a wireless station.  
2. Allow auto adjustment could make the best utilization of available bandwidth.

OK Cancel

Available settings are explained as follows:

Item	Description
<b>SSID</b>	Display the specific SSID name of the AP.
<b>Enable</b>	Check this box to enable the bandwidth management for clients.
<b>Upload Limit</b>	Define the maximum speed of the data uploading which will be used for the wireless stations connecting to Vigor AP with the same SSID. Use the drop down list to choose the rate. If you choose <b>User defined</b> , you have to specify the rate manually.
<b>Download Limit</b>	Define the maximum speed of the data downloading which will be used for the wireless station connecting to Vigor AP with the same SSID. Use the drop down list to choose the rate. If you choose <b>User defined</b> , you have to specify the rate manually.
<b>Auto Adjustment</b>	Check this box to have the bandwidth limit determined by the system automatically.
<b>Total Upload Limit</b>	When Auto Adjustment is checked, the value defined here will be treated as the total bandwidth shared by all of the wireless stations with the same SSID for data uploading.
<b>Total Download Limit</b>	When Auto Adjustment is checked, the value defined here will be treated as the total bandwidth shared by all of the wireless stations with the same SSID for data downloading.

After finishing this web page configuration, please click **OK** to save the settings.

### 3.5.8 Airtime Fairness

Airtime fairness is essential in wireless networks that must support critical enterprise applications.

Most of the applications are either symmetric or require more downlink than uplink capacity; telephony and email send the same amount of data in each direction, while video streaming and web surfing involve more traffic sent from access points to clients than the other way around. This is essential for ensuring predictable performance and quality-of-service, as well as allowing 802.11n and legacy clients to coexist on the same network. Without airtime fairness, offices using mixed mode networks risk having legacy clients slow down the entire network or letting the fastest client(s) crowd out other users.

With airtime fairness, every client at a given quality-of-service level has equal access to the network's airtime.

The wireless channel can be accessed by only one wireless station at the same time.

The principle behind the IEEE802.11 channel access mechanisms is that each station has **equal probability** to access the channel. When wireless stations have similar data rate, this principle leads to a fair result. In this case, stations get similar channel access time which is called airtime.

However, when stations have various data rate (e.g., 11g, 11n), the result is not fair. The slow stations (11g) work in their slow data rate and occupy too much airtime, whereas the fast stations (11n) become much slower.

Take the following figure as an example, both Station A(11g) and Station B(11n) transmit data packets through VigorAP 810. Although they have equal probability to access the wireless channel, Station B(11n) gets only a little airtime and waits too much because Station A(11g) spends longer time to send one packet. In other words, Station B(fast rate) is obstructed by Station A(slow rate).

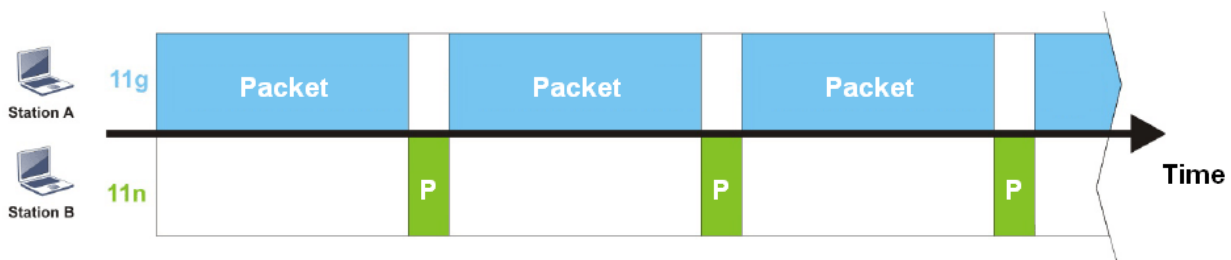

To improve this problem, Airtime Fairness is added for VigorAP 810. Airtime Fairness function tries to assign *similar airtime* to each station (A/B) by controlling TX traffic. In the following figure, Station B(11n) has higher probability to send data packets than Station A(11g). By this way, Station B(fast rate) gets fair airtime and it's speed is not limited by Station A(slow rate).

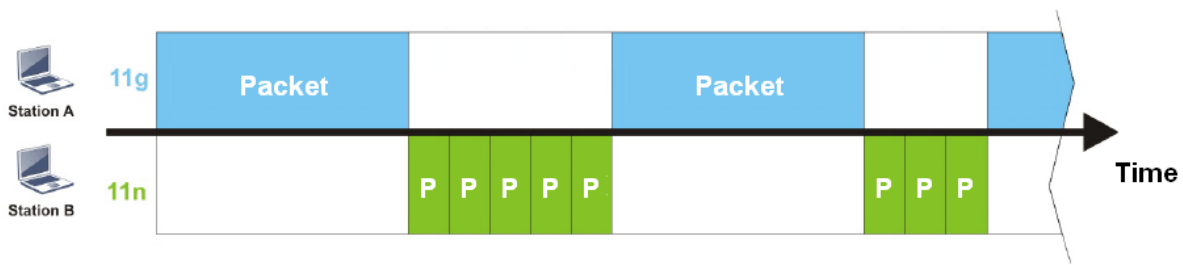

It is similar to automatic Bandwidth Limit. The dynamic bandwidth limit of each station depends on instant active station number and airtime assignment. Please note that Airtime Fairness of 2.4GHz and 5GHz are independent. But stations of different SSIDs function together, because they all use the same wireless channel. IN SPECIFIC ENVIRONMENTS, this function can reduce the bad influence of slow wireless devices and improve the overall wireless performance.

Suitable environment:

- (1) Many wireless stations.
- (2) All stations mainly use download traffic.
- (3) The performance bottleneck is wireless connection.

**Wireless LAN >> Airtime Fairness**

Enable **Airtime Fairness**  
 Triggering Client Number  (2 ~ 64, Default: 2)

**Note:** Please enable or disable this function according to the real situation and user experience. It is NOT suitable for all environments. You could check [Diagnostics >> Station Airtime](#) Graph first.

Available settings are explained as follows:

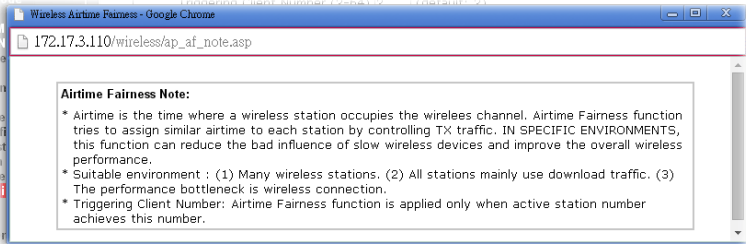
Item	Description
<b>Enable Airtime Fairness</b>	<p>Try to assign similar airtime to each wireless station by controlling TX traffic.</p> <p><b>Airtime Fairness</b> – Click the link to display the following screen of airtime fairness note.</p>  <p><b>Triggering Client Number</b> –Airtime Fairness function is applied only when active station number achieves this number.</p>

After finishing this web page configuration, please click **OK** to save the settings.

**Note:** Airtime Fairness function and Bandwidth Limit function should be mutually exclusive. So their webs have extra actions to ensure these two functions are not enabled simultaneously.

### 3.5.9 Station Control

Station Control is used to specify the duration for the wireless client to connect and reconnect VigorAP. If such function is not enabled, the wireless client can connect VigorAP until it shuts down.

Such feature is especially useful for free Wi-Fi service. For example, a coffee shop offers free Wi-Fi service for its guests for one hour every day. Then, the connection time can be set as “1 hour” and reconnection time can be set as “1 day”. Thus, the guest can finish his job within one hour and will not occupy the wireless network for a long time.

**Note:** Up to 300 Wireless Station records are supported by VigorAP.

Wireless LAN >> Station Control

SSID 1	SSID 2	SSID 3	SSID 4
SSID	DrayTek-LAN-A		
Enable	<input type="checkbox"/>		
Connection Time	1 hour		
Reconnection Time	1 day		
<a href="#">Display All Station Control List</a>			

**Note:** Once the feature is enabled, the connection time quota will apply to each wireless client (identified by MAC address).

OK Cancel

Available settings are explained as follows:

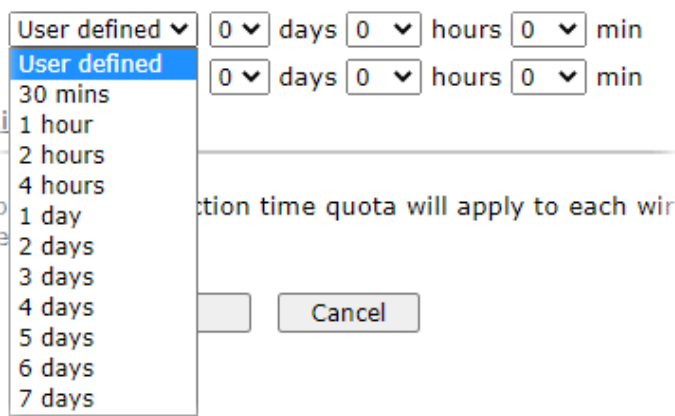
Item	Description
<b>SSID</b>	Display the SSID that the wireless station will use it to connect with Vigor router.
<b>Enable</b>	Check the box to enable the station control function.
<b>Connection Time / Reconnection Time</b>	Use the drop down list to choose the duration for the wireless client connecting /reconnecting to Vigor router. Or, type the duration manually when you choose <b>User defined</b> . 

<b>Display All Station Control List</b>	All the wireless stations connecting to Vigor router by using such SSID will be listed on Station Control List.
---	---

After finishing all the settings here, please click **OK** to save the configuration.

### 3.5.10 Roaming

The network signal for a single wireless access point might be limited by its coverage range. Therefore, if you want to expand the wireless network in a large exhibition with a quick method, you can install multiple access points with enabling the Roaming feature for each AP to reach the purpose of expanding wireless signals seamlessly.

These access points connecting for each other shall be verified by pre-authentication. This page allows you to enable the roaming feature and the pre-authentication.

Wireless LAN >> Roaming

#### AP-assisted Client Roaming Parameters

<input type="checkbox"/> <b>Minimum Basic Rate</b>	1 Mbps
<input checked="" type="radio"/> <b>Disable RSSI Requirement</b>	
<input type="radio"/> <b>Strictly Minimum RSSI</b>	-73 dBm (42 %) (Default: -73)
<input type="radio"/> <b>Minimum RSSI</b>	-66 dBm (60 %) (Default: -66)
with Adjacent AP RSSI over	5 dB (Default: 5)

#### Fast Roaming(WPA2 Enterprise)

<input type="checkbox"/> <b>Enable</b>	
<b>PMK Caching</b> : Cache Period	10 minutes (10 ~ 600, Default: 10)
<b>Pre-Authentication</b>	

OK Cancel

Available settings are explained as follows:

Item	Description
<b>AP-assisted Client Roaming Parameters</b>	<p>When the link rate of wireless station is too low or the signal received by the wireless station is too worse, VigorAP 810 will automatically detect (based on the link rate and RSSI requirement) and cut off the network connection for that wireless station to assist it to connect another Wireless AP to get better signal.</p> <p><b>Minimum Basic Rate</b> – Check the box to use the drop down list to specify a basic rate (<b>Mbps</b>). When the link rate of the wireless station is below such value, VigorAP 810 will terminate the network connection for that wireless station.</p> <p><b>Disable RSSI Requirement</b> - If it is selected, VigorAP will not terminate the network connection based on RSSI.</p> <p><b>Strictly Minimum RSSI</b> - VigorAP uses RSSI (received signal strength indicator) to decide to terminate the network connection of wireless station. When the signal strength is below the value (<b>dBm</b>) set here, VigorAP 810 will terminate the network connection for that wireless station.</p> <p><b>Minimum RSSI</b> - When the signal strength of the wireless</p>

	<p>station is below the value (<b>dBm</b>) set here and adjacent AP (must be DrayTek AP and support such feature too) with higher signal strength value (defined in the field of <b>With Adjacent AP RSSI over</b>) is detected by VigorAP 810, VigorAP 810 will terminate the network connection for that wireless station. Later, the wireless station can connect to the adjacent AP (with better RSSI).</p> <ul style="list-style-type: none"> <li>● <b>With Adjacent AP RSSI over</b> – Specify a value as a threshold.</li> </ul>
<p><b>Fast Roaming (WPA2 Enterprise)</b></p>	<p><b>Enable</b> – Check the box to enable fast roaming configuration.</p> <p><b>PMK Caching</b> - Set the expire time of WPA2 PMK (Pairwise master key) cache. PMK Cache manages the list from the BSSIDs in the associated SSID with which it has pre-authenticated. Such feature is available for <b>WPA2/802.11</b> mode.</p> <p><b>Pre-Authentication</b> - Enables a station to authenticate to multiple APs for roaming securer and faster. With the pre-authentication procedure defined in IEEE 802.11i specification, the pre-four-way-handshake can reduce handoff delay perceivable by a mobile node. It makes roaming faster and more secure. (Only valid in WPA2)</p>

After finishing this web page configuration, please click **OK** to save the settings.

### 3.5.11 Station List

**Station List** provides the knowledge of connecting wireless clients now along with its status code. Each tab (general, advanced, control, neighbor) will display different status information (including MAC address, Vendor, SSID, Auth, Encrypt, Tx/Rx Rate, Hostname, RSSI, Link Speed, BW, PSM, WMM, PHMd, MCS, Connection Time, Reconnection Time, Approx. Distance, Visit Time, and so on)

Wireless LAN >> Station List

Station List

							General	Advanced	Control	Neighbor
Index	MAC Address	Vendor	RSSI	Approx. Distance	SSID	Visit Time				
1	C8:FF:28:FC:2A:C1	LiteonTe	1% (-91dBm)	199.53m	N/A	0d:0h:10m:9s				
2	3C:95:09:A0:29:25	LiteonTe	1% (-92dBm)	223.87m	N/A	0d:0h:11m:29s				
3	DE:6B:80:5D:94:EC		1% (-90dBm)	177.83m	N/A	0d:0h:0m:0s				
4	B8:27:EB:CD:7C:D0	Raspberr	1% (-91dBm)	199.53m	N/A	0d:0h:48m:29s				
5	E6:11:D3:4B:64:11		7% (-87dBm)	125.89m	N/A	0d:0h:0m:0s				
6	80:00:0B:04:CE:5A	Intel	1% (-90dBm)	177.83m	N/A	0d:0h:16m:35s				
7	9A:0B:0E:D1:7F:1E		23% (-81dBm)	63.10m	N/A	0d:0h:1m:22s				
8	F8:63:3F:56:06:C6	IntelCor	1% (-93dBm)	251.19m	N/A	0d:0h:1m:2s				
9	1A:C2:FB:61:8F:F9		10% (-86dBm)	112.20m	N/A	0d:0h:0m:0s				
10	38:F9:D3:E4:E7:27	Apple	26% (-79dBm)	50.12m	N/A	0d:0h:2m:0s				
11	06:1D:AA:41:DF:18		1% (-91dBm)	199.53m	N/A	0d:19h:39m:57s				
12	E6:76:82:6C:3F:02		10% (-86dBm)	112.20m	N/A	0d:0h:0m:0s				
13	14:98:77:3F:30:B2		1% (-91dBm)	199.53m	N/A	0d:0h:0m:0s				
14	32:CA:AF:39:7F:5F		18% (-83dBm)	79.43m	N/A	0d:0h:0m:0s				
15	28:6C:07:BC:D4:4D	XIAOMIE1	5% (-88dBm)	141.25m	N/A	0d:19h:40m:19s				
16	AC:37:43:99:0D:31	HTC	1% (-92dBm)	223.87m	N/A	0d:0h:0m:0s				
17	B8:27:EB:2A:D2:F3	Raspberr	1% (-93dBm)	251.19m	N/A	0d:0h:0m:0s				
18	DA:98:C3:EE:CE:22		1% (-91dBm)	199.53m	N/A	0d:0h:0m:0s				
19	12:50:DC:02:00:10		1% (-92dBm)	223.87m	N/A	0d:0h:10m:10s				

**Add to Access Control :**

Client's MAC Address :  :  :  :  :  :

- Note:**
1. Approx. Distance is calculated by actual signal strength of device detected. Inaccuracy might occur based on barrier encountered.
  2. Due to the differences in signal strength for different devices, the calculated value of approximate distance also might be different.
  3. Trademarks and brand names are the properties of their respective owners.

Available settings are explained as follows:

Item	Description
<b>MAC Address</b>	Display the MAC Address for the connecting client.
<b>SSID</b>	Display the SSID that the wireless client connects to.
<b>Auth</b>	Display the authentication that the wireless client uses for connection with such AP.
<b>Encrypt</b>	Display the encryption mode used by the wireless client.
<b>Tx Rate/Rx Rate</b>	Display the transmission /receiving rate for packets.
<b>Refresh</b>	Click this button to refresh the status of station list.
<b>Add to Access Control</b>	<b>Client's MAC Address</b> - For additional security of wireless access, the Access Control facility allows you to restrict the network access right by controlling the wireless LAN MAC address of client. Only the valid MAC address that has been configured can access the wireless LAN interface.
<b>Add</b>	Click this button to add current typed MAC address into <b>Access Control</b> .

**General**

Display general information (e.g., MAC Address, SSID, Auth, Encrypt, TX/RX Rate) for the station.

**Advanced**

Display more information (e.g., AID, PSM, WMM, RSSI PhMd, BW, MCS, Rate) for the station.

**Control**

Display connection and reconnection time of the wireless stations.

**Neighbor**

Display more information for the neighboring wireless stations.



## 3.6 Wireless LAN Settings for Station-Infrastructure Mode

When you choose **Station-Infrastructure** as the operation mode, the Wireless LAN menu items will include General Setup, Site Survey, Statistics and WPS.

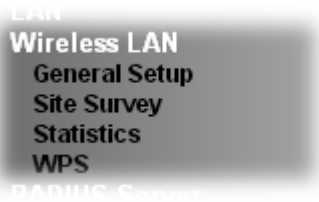

### 3.6.1 General Setup

By clicking the **General Setup**, a new web page will appear so that you could configure the wireless profile and choose proper mode. Please refer to the following figure for more information.

Wireless LAN >> General Setup

---

General Setting ( IEEE 802.11 )

Enable Wireless LAN

Mode : Mixed(11b+11g+11n) ▼

---

**Profile List**

Profile	SSID	Channel	Authentication	Encryption
<input type="button" value="Add"/> <input type="button" value="Delete"/> <input type="button" value="Edit"/> <input type="button" value="Connect"/>				

---

Packet-OVERDRIVE

Tx Burst

**Note:**

- 1.Tx Burst only supports 11g mode.
- 2.The same technology must also be supported in AP to boost WLAN performance.

MAC Clone

**Note:**

1. Please notice that the last byte of this MAC address must be a multiple of 8.

Available settings are explained as follows:

Item	Description
<b>Enable Wireless LAN</b>	Check the box to enable wireless function.
<b>Mode</b>	At present, VigorAP 810 can connect to 11 b only, 11 g only, 11 n only, Mixed (11b+11g), Mixed (11b+11g+11n) and Mixed (11g+11n) stations simultaneously. Simply choose Mixed (11b+11g+11n) mode.
<b>Add</b>	Click this button to add new wireless profiles.
<b>Delete</b>	Click this button to delete the selected wireless profile.
<b>Edit</b>	Click this button to modify the existing wireless profile.
<b>Connect</b>	Click this button to connect the wireless station to AP with the selected profile.
<b>Packet-OVERDRIVE</b>	This feature can enhance the performance in data transmission

about 40%\* more (by checking **Tx Burst**). It is active only when both sides of Access Point and Station (in wireless client) invoke this function at the same time. That is, the wireless client must support this feature and invoke the function, too.

**Note:** Vigor N61 wireless adapter supports this function. Therefore, you can use and install it into your PC for matching with Packet-OVERDRIVE (refer to the following picture of Vigor N61 wireless utility window, choose **Enable** for **TxBURST** on the tab of **Option**).

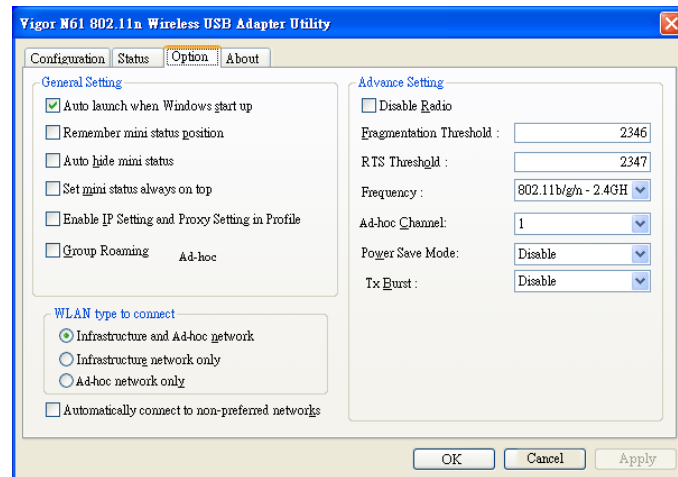

### MAC Clone

Check this box and manually enter the MAC address for Station mode driver.

After finishing this web page configuration, please click **OK** to save the settings.

### Add a New Wireless Profile

To add a new wireless profile for the stations, click **Add**. The following dialog box will appear.

The screenshot shows a web browser window titled "AP810 Wireless Station Add Profile - Google Chrome" with the address bar showing "192.168.1.2/wireless/add\_profile\_page.asp". The page content is as follows:

System Configuration	
Profile Name	PROF001
SSID	
Network Type	Infrastructure
Power Saving Mode	<input checked="" type="radio"/> CAM (Constantly Awake Mode) <input type="radio"/> Power Saving Mode
RTS Threshold	<input type="checkbox"/> Used 2347
Fragment Threshold	<input type="checkbox"/> Used 2346

Security Policy	
Security Mode	OPEN

WEP		
WEP Key Length	64 bit (10 hex digits / 5 ascii keys)	
WEP Key Entry Method	Hexadecimal	
WEP Keys	WEP Key 1 :	
	WEP Key 2 :	
	WEP Key 3 :	
	WEP Key 4 :	
Default Key	Key 1	

Available settings are explained as follows:

Item	Description
<b>Profile Name</b>	Type a name for the new profile.
<b>SSID</b>	Type the name for such access point that can be used for connection by the stations.
<b>Network Type</b>	<p><b>Infrastructure</b> - In this mode, you can connect the access point to Ethernet device such as TV and Game player to enable the Ethernet device as a wireless station and join to a wireless network through an access point or AP router.</p> <p><b>802.11 Ad Hoc</b> – An ad-hoc network is a network where wireless stations can communicate with peer to peer (P2P).</p>
<b>Power Saving Mode</b>	<p>Choose the power saving mode for such device.</p> <p><b>CAM</b> – Choose this item if it is not necessary to perform power saving job.</p> <p><b>Power Saving Mode</b> – Choose this item to get into the power saving status when there is no data passing through the access point.</p>
<b>RTS Threshold</b>	Set the RTS threshold of wireless radio. Do not modify default value if you don't know what it is, default value is 2347.

<b>Fragment Threshold</b>	Set the Fragment threshold of wireless radio. Do not modify default value if you don't know what it is, default value is 2346.
<b>Security Mode</b>	<p>802.11 standard defines two mechanisms for authentication of wireless LAN clients: Open Authentication and Shared Key Authentication.</p> <p>Choose one of the security modes from the drop down list. If you choose OPEN or SHARED, you have to type WEP information.</p> <p><b>OPEN</b> – Open authentication is basically null authentication algorithm, which means that there is no verification of the user.</p> <p><b>SHARED</b> – It works similar to Open authentication with only one major difference. If you choose OPEN with WEP encryption key, the WEP keys is used to encrypt and decrypt the data but not for authentication. In Shared key authentication, WEP encryption will be used for authentication.</p>  <p>If you choose <b>WPA-Personal</b> or <b>WPA2-Personal</b>, the corresponding WPA settings will be listed as follows. You have to choose the WPA algorithms and type the pass phrase for such security mode.</p> <p><b>WPA Algorithms</b> – Choose Temporal Key Integrity Protocol (TKIP) or AES for data encryption.</p> <p><b>Pass Phrase</b> – Please type 8 to 63 alphanumerical characters here.</p>
<b>WEP</b>	<p><b>WEP Key Length</b> - WEP (Wired Equivalent Privacy) is a common encryption mode. It is safe enough for home and personal use. However, if you need higher level of security, please consider using WPA encryption (see next section).</p> <p>Some wireless clients do not support WPA, but support WEP. Therefore WEP is still a good choice for you if you have such kind of client in your network environment.</p>  <p><b>WEP Key Entry Method</b> - There are two types of WEP key length: 64-bit and 128-bit. Using 128-bit is safer than 64-bit, but it will reduce some data transfer performance.</p> <p>There are two types of key method: ASCII and Hex. When you select a key format, the number of characters of key will be displayed. For example, if you select 64-bit as key length, and Hex as key format, you'll see the message at the right of</p>

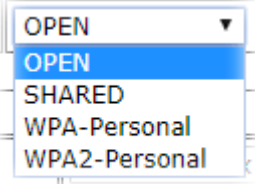
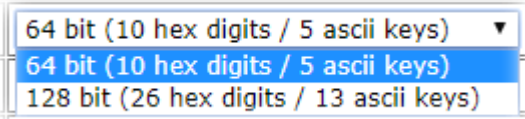
Key Format is 'Hex (10 characters)' which means the length of WEP key is 10 characters.

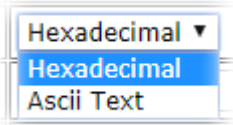

**WEP Keys (Key 1 – Key 4)** - Four keys can be entered here, but only one key can be selected at a time. The format of WEP Key is restricted to 5 ASCII characters or 10 hexadecimal values in 64-bit encryption level, or restricted to 13 ASCII characters or 26 hexadecimal values in 128-bit encryption level. The allowed content is the ASCII characters from 33(!) to 126(~) except '#' and '.'. Such feature is available for **WEP** mode.

**Default Key** – Choose one of the key settings.

Below shows an example for a wireless profile created.

Wireless LAN >> General Setup

General Setting ( IEEE 802.11 )

Enable Wireless LAN  
Mode :

**Profile List**

	Profile	SSID	Channel	Authentication	Encryption
<input type="radio"/>	PROF001	vigor_1	Auto	OPEN	WEP

Packet-OVERDRIVE

Tx Burst

**Note:**

1. Tx Burst only supports 11g mode.  
2. The same technology must also be supported in AP to boost WLAN performance.

MAC Clone

**Note:**

1. Please notice that the last byte of this MAC address must be a multiple of 8.

### 3.6.2 Site Survey

The page will list the access points nearby as VigorAP 810 is set to Station mode. You can select one of the access points to associate.

Wireless LAN >> Station Site Survey

#### Site Survey

	SSID	BSSID	RSSI	Channel	Encryption	Authentication
<input type="radio"/>	staffs	02-50-7F-C1-7F-1D	44%	1	AES	WPA2/PSK
<input type="radio"/>	guests	02-50-7F-D1-7F-1D	50%	1	AES	WPA2/PSK
<input type="radio"/>	staffs	02-1D-AA-48-5F-80	29%	1	AES	WPA2/PSK
<input type="radio"/>	guests	02-1D-AA-58-5F-80	29%	1	AES	WPA2/PSK
<input type="radio"/>	DrayTek	16-49-BC-4D-8F-00	70%	6	AES	WPA2/PSK
<input type="radio"/>	AP920R-PQC...	0A-1D-AA-63-2C-00	39%	9	TKIP/AES	WPA2/PSK
<input type="radio"/>	Vigor2926n...	0E-1D-AA-63-2C-00	39%	9	AES	WPA2/PSK
<input type="radio"/>	AP920R-PQC...	00-1D-AA-63-2C-00	39%	9	TKIP/AES	Mixed(WPA+WPA2)/PSK
<input type="radio"/>	AP920R-PQC...	06-1D-AA-63-2C-00	39%	9	TKIP/AES	Mixed(WPA+WPA2)/PSK
<input type="radio"/>	DrayTek-04...	00-1D-AA-04-F0-6C	20%	11	TKIP/AES	Mixed(WPA+WPA2)/PSK
<input type="radio"/>	DrayTek-F1...	02-50-7F-C1-92-16	29%	11	AES	WPA2/PSK
<input type="radio"/>	staffs_5F	02-50-7F-C1-7F-1F	15%	1	AES	WPA2/PSK
<input type="radio"/>	guests	02-50-7F-D1-7F-1F	15%	1	AES	WPA2/PSK
<input type="radio"/>		22-1D-AA-80-FE-D4	10%	4	AES	WPA2/PSK
<input type="radio"/>		12-1D-AA-04-F0-60	1%	11	AES	WPA2/PSK
<input type="radio"/>	DrayTek-3F...	00-1D-AA-3F-47-64	55%	11	AES	WPA2/PSK
<input type="radio"/>	DrayTek-7C...	00-1D-AA-7C-F5-A4	34%	11	AES	WPA2/PSK
<input type="radio"/>	DrayTek-F1...	02-50-7F-C1-91-BC	5%	11	AES	WPA2/PSK
<input type="radio"/>	TEST1060	00-1D-AA-80-FE-D4	1%	4	TKIP/AES	Mixed(WPA+WPA2)/PSK
<input type="radio"/>	gfhfg	12-1D-AA-80-FE-D4	1%	4	AES	WPA2/PSK
<input type="radio"/>		22-1D-AA-7C-F5-A4	34%	11	AES	WPA2/PSK
<input type="radio"/>	v2927 PQC ...	16-49-BC-42-38-48	1%	11	AES	WPA2/PSK
<input type="radio"/>	RD8_test24...	02-1D-AA-80-06-C4	1%	11	AES	WPA/PSK
<input type="radio"/>		22-1D-AA-80-FE-B8	1%	11	AES	WPA2/PSK
<input type="radio"/>	DrayTek-F1...	02-50-7F-C1-7E-E8	1%	11	AES	WPA2/PSK
<input type="radio"/>	DrayTek	02-1D-AA-4A-CF-C0	1%	6	AES	WPA2/PSK
<input type="radio"/>	RD8-Eric-2...	02-1D-AA-41-DF-18	5%	11	TKIP/AES	Mixed(WPA+WPA2)/PSK
<input type="radio"/>	v2927 PQC ...	00-1D-AA-80-FE-B8	1%	11	AES	WPA2/PSK
<input type="radio"/>	v2927 PQC ...	00-1D-AA-3F-4F-4C	5%	11	AES	WPA2/PSK
<input type="radio"/>	v2927 PQC ...	00-1D-AA-EE-27-E4	1%	11	AES	WPA2/PSK
<input type="radio"/>	RD8_test24...	00-1D-AA-80-06-C4	1%	11	TKIP/AES	Mixed(WPA+WPA2)/PSK
<input type="radio"/>		12-1D-AA-3F-4F-4C	1%	11	AES	WPA2/PSK

Rescan    Connect    Add Profile

Available settings are explained as follows:

Item	Description
<b>SSID</b>	Display the SSID name of the access point.
<b>BSSID</b>	Display the BSSID (MAC Address) of the access point.
<b>RSSI</b>	Display the signal strength of the access point. RSSI is the abbreviation of Receive Signal Strength Indication.
<b>Channel</b>	Display the channel number of the access point.
<b>Encryption</b>	Display the encryption setting of the access points. If you have selected the access point with security setting, you have to go to 2-7 Wireless Security to set the same security with the access point you want to associate.
<b>Authentication</b>	Display the authentication type of the access point.

<b>Scan/Rescan</b>	Search the stations connected to such access point.
<b>Connect</b>	Connect to the wireless AP that you choose.
<b>Add Profile</b>	The system will add a profile automatically for you to connect with the wireless AP that you choose.

### 3.6.3 Statistics

This page displays the statistics for data transmission and receiving between the access point and the stations.

#### Wireless LAN >> Station Statistics

##### Transmit Statistics

Frames Transmitted Successfully	7181
Frames Transmitted Successfully Without Retry	7181
Frames Transmitted Successfully After Retry(s)	0
Frames Fail To Receive ACK After All Retries	0
RTS Frames Successfully Receive CTS	0
RTS Frames Fail To Receive CTS	0

##### Receive Statistics

Frames Received Successfully	38325
Frames Received With CRC Error	149710
Frames Dropped Due To Out-of-Resource	0
Duplicate Frames Received	418

Reset Counters

### 3.6.4 WPS (Wi-Fi Protected Setup)

Wi-Fi Protected Setup (WPS) is the simplest way to build connection between wireless network clients and the access point. You don't have to select encryption mode and input a long encryption passphrase every time when you need to setup a wireless client. You only have to press a button on wireless client and the access point, and the WPS will do the setup for you.

VigorAP 810 supports two types of WPS: Push-Button Configuration (PBC), and PIN code. If you want to use PBC, you have to switch VigorAP 810 to WPS mode and push a specific button on the wireless client to start WPS mode. You can push Reset/WPS button of this VigorAP 810, or click **PBC Start** button in the web configuration interface to do this; if you want to use PIN code, you have to provide the PIN code of the wireless client you wish to connect to this access point and then switch the wireless client to WPS mode.

**Note:** WPS function of VigorAP 810 will not work for those wireless AP/clients do not support WPS.

To use WPS function to set encrypted connection between VigorAP 810 and WPS-enabled wireless AP, please open **Wireless LAN >>WPS**. The following information will be displayed:

Wireless LAN >> Wi-Fi Protected Setup (STA)

WPS AP site survey

No.	SSID	BSSID	RSSI	ch.	Auth.	Encrypt	ver.	Status
<input checked="" type="radio"/>	staffs	021DAA485F80	20%	1	WPA2/PSK	AES	1.0	Unconf.
<input type="radio"/>	DrayTek	1649BC4D8F00	70%	6	WPA2/PSK	AES	1.0	Unconf.
<input type="radio"/>	RD8_GW_24G_s1	001DAA5BA0C8	1%	13	Mixed(WPA+WPA2)/PSK	TKIP/AES	1.0	Unconf.
<input type="radio"/>	DrayTek	021DAA4ACFC0	1%	6	WPA2/PSK	AES	1.0	Unconf.
<input type="radio"/>	RD8-Eric-2865-SSID1	021DAA41DF18	1%	11	Mixed(WPA+WPA2)/PSK	TKIP/AES	1.0	Unconf.

Device Configure

Configure via Push Button	<input type="button" value="Start PBC"/>
Configure via Client PinCode	<input type="text"/> <input type="button" value="Start PIN"/> <input type="button" value="Renew PIN"/>
	<input type="button" value="Cancel"/>

Status: Idle

Available settings are explained as follows:

Item	Description
<b>SSID</b>	Display the SSID name of the access point.
<b>BSSID</b>	Display the BSSID (MAC Address) of the access point.
<b>RSSI</b>	Display the signal strength of the access point. RSSI is the abbreviation of Receive Signal Strength Indication.
<b>Ch. (Channel)</b>	Display the channel number of the access point.
<b>Auth. (Authentication)</b>	Display the authentication type of the access point.
<b>Encrypt (Encryption)</b>	Display the encryption setting of the access points. If you have selected the access point with security setting, you have to go to 2-7 Wireless Security to set the same security with the access point you want to associate.
<b>Ver. (Version)</b>	Display the version of WPS.
<b>Status</b>	Display the status of WPS access point.
<b>Refresh</b>	Click this button to refresh the AP site survey.
<b>Start PBC</b>	Click <b>Start PBC</b> to make a WPS connection within 2 minutes.
<b>PIN Start</b>	When using PinCode method, it is required to enter PIN Code (Personal Identification Number Code, 8-digit numbers) into Registrar. When the wireless station is Enrollee, the users can use Renew PIN to re-generate a new PIN code.
<b>Renew PIN</b>	Click this button to re-generate a new PIN code.

**Note:** When you're using PBC type WPS setup, you must press **PBC** button (hardware or software) of wireless client within 2 minutes. If you didn't press **PBC** button of wireless client within this time period, please press **PBC** button (hardware or software) of this access point again.



## 3.7 Wireless LAN Settings for AP Bridge-Point to Point/AP Bridge-Point to Multi-Point Mode

When you choose AP Bridge-Point to Point or Point-to Multi-Point Mode as the operation mode, the Wireless LAN menu items will include General Setup, Advanced Setting, AP Discovery and WDS AP Status.



AP Bridge-Point to Point allows VigorAP 810 to connect to **another** VigorAP 810 which uses the same mode. All wired Ethernet clients of both VigorAP 810s will be connected together.

Point-to Multi-Point Mode allows AP 810 to connect up to **four** AP 810s which uses the same mode. All wired Ethernet clients of every VigorAP 810 will be connected together.

### 3.7.1 General Setup

By clicking the **General Setup**, a new web page will appear so that you could configure the Phy mode, security, Tx Burst and choose proper mode. Please refer to the following figure for more information.

Wireless LAN >> General Setup

**General Setting ( IEEE 802.11 )**

Enable Wireless LAN

Mode : Mixed(11b+11g+11n) ▼

Channel : 2462MHz (Channel 11) ▼

Extension Channel : 2442MHz (Channel 7) ▼

---

**WDS Settings (PHY Mode : HTMIX)**

**Security :**

Disabled  WEP  TKIP  AES

Key :

**Peer MAC Address :**

:  :  :  :  :

Note: Enter the configuration of APs which AP810 want to connect.

OK
Cancel

Available settings are explained as follows:

Item	Description
<b>Enable Wireless LAN</b>	Check the box to enable wireless function.
<b>Mode</b>	At present, VigorAP 810 can connect to 11b only, 11g only, 11n only, Mixed (11b+11g), Mixed (11g+11n) and Mixed (11b+11g+11n) stations simultaneously. Simply choose Mixed (11b+11g+11n) mode.
<b>Channel</b>	Means the channel of frequency of the wireless LAN. The default channel is 11. You may switch channel if the selected channel is under serious interference. If you have no idea of

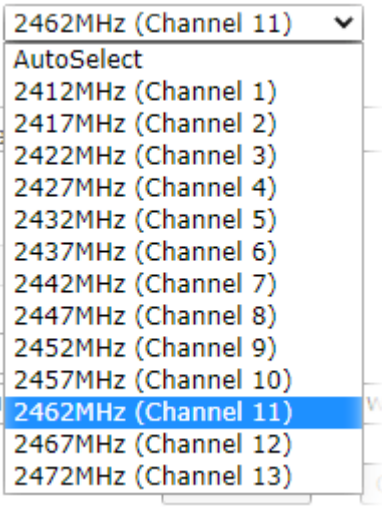
	<p>choosing the frequency, please select <b>AutoSelect</b> to let system determine for you.</p> 
<b>Extension Channel</b>	With 802.11n, there is one option to double the bandwidth per channel. The available extension channel options will be varied according to the <b>Channel</b> selected above.
<b>PHY Mode</b>	HTMIX (11b/g/n mixed mode) is specified VigorAP 810.
<b>Security</b>	Select WEP, TKIP or AES as the encryption algorithm. Type the key number if required. Or click <b>Disabled</b> to ignore such feature.
<b>Peer Mac Address</b>	Type the peer MAC address for the access point that VigorAP 810 connects to.

After finishing this web page configuration, please click **OK** to save the settings.

### 3.7.2 Advanced Setting

This page is to determine which algorithm will be selected for wireless transmission rate.

Wireless LAN >> Advanced Setting

Channel Bandwidth	<input type="radio"/> 20 MHz <input checked="" type="radio"/> Auto 20/40 MHz <input type="radio"/> 40 MHz
Packet-OVERDRIVE™ Tx Burst	<input type="radio"/> Enable <input checked="" type="radio"/> Disable (For 11g mode only)
Antenna	<input checked="" type="radio"/> 2T2R <input type="radio"/> 1T1R (1T1R would use the right antenna)
Tx Power	<input checked="" type="radio"/> 100% <input type="radio"/> 80% <input type="radio"/> 60% <input type="radio"/> 30% <input type="radio"/> 20% <input type="radio"/> 10%
Rate Adaptation Algorithm	<input checked="" type="radio"/> New <input type="radio"/> Old
Fragment Length (256 - 2346)	<input type="text" value="2346"/> bytes
RTS Threshold (1 - 2347)	<input type="text" value="2347"/> bytes
Country Code	<input type="text"/> (Reference)
Auto Channel Filtered Out List	<input type="checkbox"/> 1 <input type="checkbox"/> 2 <input type="checkbox"/> 3 <input type="checkbox"/> 4 <input type="checkbox"/> 5 <input type="checkbox"/> 6 <input type="checkbox"/> 7 <input type="checkbox"/> 8 <input type="checkbox"/> 9 <input type="checkbox"/> 10 <input type="checkbox"/> 11 <input type="checkbox"/> 12 <input type="checkbox"/> 13
IGMP Snooping	<input checked="" type="radio"/> Enable <input type="radio"/> Disable
WMM Capable	<input type="radio"/> Enable <input checked="" type="radio"/> Disable
MAC Clone	<input type="radio"/> Enable <input checked="" type="radio"/> Disable <input type="text"/>
<b>MAC Clone:</b>	Set the MAC address of SSIDs and the Wireless client. Please notice that the last byte of this MAC address must be a multiple of 8.

Available settings are explained as follows:

Item	Description
<b>Channel Bandwidth</b>	<p><b>20 MHz-</b> the device will use 20MHz for data transmission and receiving between the AP and the stations.</p> <p><b>Auto 20/40 MHz-</b> the AP will scan for nearby wireless AP, and then use 20MHz if the number of AP is more than 10, or use 40MHz if it's not.</p> <p><b>40 MHz-</b> the device will use 40MHz for data transmission and receiving between the AP and the stations.</p>
<b>Packet-OVERDRIVE</b>	<p>This feature can enhance the performance in data transmission about 40%* more (by checking <b>Tx Burst</b>). It is active only when both sides of Access Point and Station (in wireless client) invoke this function at the same time. That is, the wireless client must support this feature and invoke the function, too.</p> <p><b>Note:</b> Vigor N61 wireless adapter supports this function. Therefore, you can use and install it into your PC for matching with Packet-OVERDRIVE (refer to the following picture of Vigor N61 wireless utility window, choose <b>Enable</b> for <b>TxBURST</b> on the tab of <b>Option</b>).</p>

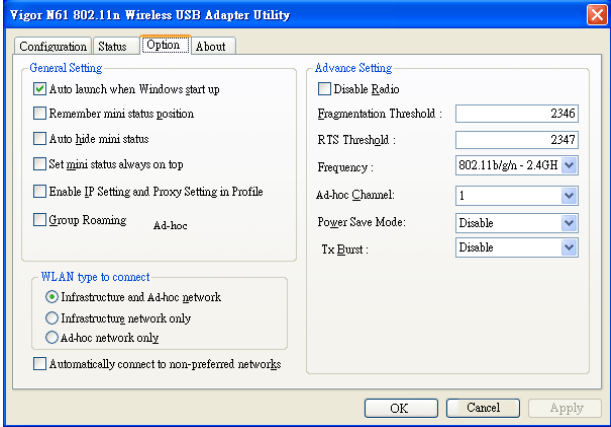
	
<b>Antenna</b>	VigorAP can be attached with two antennas to have good data transmission via wireless connection. However, if you have only one antenna attached, please choose 1T1R.
<b>Tx Power</b>	The default setting is the maximum (100%). Lowering down the value may degrade range and throughput of wireless.
<b>Rate Adaptation Algorithm</b>	Wireless transmission rate is adapted dynamically. Usually, performance of “new” algorithm is better than “old”.
<b>Fragment Length</b>	Set the Fragment threshold of wireless radio. Do not modify default value if you don’t know what it is, default value is 2346.
<b>RTS Threshold</b>	<p>Minimize the collision (unit is bytes) between hidden stations to improve wireless performance.</p> <p>Set the RTS threshold of wireless radio. Do not modify default value if you don’t know what it is, default value is 2347.</p>
<b>Country Code</b>	VigorAP broadcasts country codes by following the 802.11d standard. However, some wireless stations will detect / scan the country code to prevent conflict occurred. If conflict is detected, wireless station will be warned and is unable to make network connection. Therefore, changing the country code to ensure successful network connection will be necessary for some clients.
<b>Auto Channel Filtered Out List</b>	The selected wireless channels will be discarded if <b>AutoSelect</b> is selected as <b>Channel</b> selection mode in <b>Wireless LAN&gt;&gt;General Setup</b> .
<b>IGMP Snooping</b>	Check <b>Enable</b> to enable IGMP Snooping. Multicast traffic will be forwarded to ports that have members of that group. Disabling IGMP snooping will make multicast traffic treated in the same manner as broadcast traffic.
<b>WMM Capable</b>	To apply WMM parameters for wireless data transmission, please click the <b>Enable</b> radio button.
<b>MAC Clone</b>	Click <b>Enable</b> and manually enter the MAC address of the device with SSID 1. The MAC address of other SSIDs will change based on this MAC address.

### 3.7.3 AP Discovery

VigorAP 810 can scan all regulatory channels and find working APs in the neighborhood. Based on the scanning result, users will know which channel is clean for usage. Also, it can be used to facilitate finding an AP for a WDS link. Notice that during the scanning process (about 5 seconds), no client is allowed to connect to VigorAP 810.

This page is used to scan the existence of the APs on the wireless LAN. Yet, only the AP which is in the same channel of VigorAP 810 can be found. Please click **Scan** to discover all the connected APs.

Wireless LAN >> Access Point Discovery

#### Access Point List

Enable AP Monitor Mode

Select	Index	SSID	BSSID	RSSI	Channel	Encryption	Authentication	Mode	Ch. Width
<input type="radio"/>	1	staffs_5F_...	00:1d:aa:f8:c9:c8	91%	1	TKIP/AES	Mixed(WPA+WPA2)/PSK	11b/g/n	20
<input type="radio"/>	2	guests_v29...	02:1d:aa:f8:c9:c8	86%	1	TKIP/AES	Mixed(WPA+WPA2)/PSK	11b/g/n	20
<input type="radio"/>	3	staffs_v29...	02:1d:aa:f9:c9:c8	96%	1	TKIP/AES	Mixed(WPA+WPA2)/PSK	11b/g/n	20
<input type="radio"/>	4	800_5b70_t...	00:1d:aa:2a:5b:71	34%	6	NONE		11b/g/n	40
<input type="radio"/>	5	staffs_6F	00:1d:aa:9c:f6:44	70%	6	TKIP/AES	Mixed(WPA+WPA2)/PSK	11b/g/n	20
<input type="radio"/>	6	staffs	02:1d:aa:9c:f6:44	86%	6	TKIP/AES	Mixed(WPA+WPA2)/PSK	11b/g/n	20
<input type="radio"/>	7	guests	06:1d:aa:9c:f6:44	86%	6	TKIP/AES	Mixed(WPA+WPA2)/PSK	11b/g/n	20
<input type="radio"/>	8	DrayTek	00:1d:aa:f7:c0:08	44%	6	NONE		11b/g/n	20
<input type="radio"/>	9	staffs	02:1d:aa:9d:68:ac	24%	8	TKIP/AES	Mixed(WPA+WPA2)/PSK	11b/g/n	40
<input type="radio"/>	10	guests	0a:1d:aa:9d:68:ac	39%	8	TKIP/AES	Mixed(WPA+WPA2)/PSK	11b/g/n	40
<input type="radio"/>	11	RD8_ACS_TE...	00:1d:aa:f7:a9:00	44%	11	TKIP/AES	Mixed(WPA+WPA2)/PSK	11b/g/n	20
<input type="radio"/>	12	Stephen Li	48:5a:3f:7e:88:ed	34%	11	AES	WPA2/PSK	11b/g/n	20
<input type="radio"/>	13	Vigor2862-...	00:1d:aa:9e:2b:38	60%	11	TKIP/AES	Mixed(WPA+WPA2)/PSK	11b/g/n	20
<input type="radio"/>	14	Vigor2862-...	ff:ff:66:77:64	70%	11	TKIP/AES	Mixed(WPA+WPA2)/PSK	11b/g/n	20
<input type="radio"/>	15	mars	00:1d:aa:e4:86:d8	34%	13	AES	WPA2/PSK	11b/g/n	20
<input type="radio"/>	16	DrayTek_Ia...	00:1d:aa:00:00:00	100%	11	NONE		11b/g/n	20
<input type="radio"/>	17	DrayTek	00:1d:aa:f7:c0:f0	100%	11	NONE		11b/g/n	20
<input type="radio"/>	18	DrayTek	00:1d:aa:74:da:38	100%	11	TKIP/AES	Mixed(WPA+WPA2)/PSK	11b/g/n	20
<input type="radio"/>	19	DrayTek	00:1d:aa:80:06:b8	34%	11	TKIP/AES	Mixed(WPA+WPA2)/PSK	11b/g/n	20

Scan

See [Channel Interference](#)

**Note:** During the scanning process (about 5 seconds), no station is allowed to connect with the AP.

AP's MAC Address  :  :  :  :  :

AP's SSID

Add to WDS Settings:

Available settings are explained as follows:

Item	Description
<b>Enable AP Monitor Mode</b>	This function can help to get and keep the records of APs detected by such device after clicking Scan.  In general, only the available AP will be detected by Vigor device. Once the AP is unavailable, it will be deleted from the Access Point List immediately. However, if such function is enabled, the system will keep the record of the AP (once detected by Vigor device) until it is available for Vigor device again.
<b>SSID</b>	Display the SSID of the AP scanned by VigorAP 810.
<b>BSSID</b>	Display the MAC address of the AP scanned by VigorAP 810.
<b>RSSI</b>	Display the signal strength of the access point. RSSI is the abbreviation of Receive Signal Strength Indication.
<b>Channel</b>	Display the wireless channel used for the AP that is scanned by VigorAP 810.
<b>Encryption</b>	Display the encryption mode for the scanned AP.
<b>Authentication</b>	Display the authentication type that the scanned AP applied.
<b>Mode</b>	Display the wireless connection mode that the scanned AP

	used.
<b>Ch. Width</b>	Display the channel width that the scanned AP used.
<b>Scan</b>	It is used to discover all the connected AP. The results will be shown on the box above this button
<b>Channel Statistics</b>	It displays the statistics for the channels used by APs.
<b>AP's MAC Address</b>	If you want the found AP applying the WDS settings, please type in the AP's MAC address.
<b>AP's SSID</b>	To specify an AP to be applied with WDS settings, you can specify MAC address or SSID for the AP. Here is the place that you can type the SSID of the AP.
<b>Add</b>	Type the MAC address of the AP. Click <b>Add</b> . Later, the MAC address of the AP will be added and be shown on WDS settings page.

### 3.7.4 WDS AP Status

VigorAP 810 can display the status such as MAC address, physical mode, power save and bandwidth for the working AP connected with WDS. Click **Refresh** to get the newest information.

Wireless LAN >> WDS AP Status

---

#### WDS AP List

AID	MAC Address	802.11 Physical Mode	Power Save	Bandwidth
1	00:50:7F:C9:76:0C	CCK	OFF	20M

### 3.8 Wireless LAN Settings for AP Bridge-WDS Mode

When you choose AP Bridge-WDS as the operation mode, the Wireless LAN menu items will include General Setup, Security, Access Control, WPS, Advanced Setting, AP Discovery, WDS AP Status, Bandwidth Management, Airtime Fairness, Station Control and Roaming.





### 3.8.1 General Setup

By clicking the **General Setup**, a new web page will appear so that you could configure the Phy mode, security, Tx Burst and choose proper mode. Please refer to the following figure for more information.

Wireless LAN >> General Setup

#### General Setting ( IEEE 802.11 )

Enable Wireless LAN

Enable Client Limit  (3 ~ 64, default: 64)

Enable Client Limit per SSID (3 ~ 64, default: 64)

---

Mode :

Channel :

Extension Channel :

---

Enable 2 Subnet (Simulate 2 APs)

	Enable	Hide SSID	SSID	Subnet	Isolate LAN	Isolate Member	VLAN ID (0:Untagged)
1	<input type="checkbox"/>	<input type="checkbox"/>	<input type="text" value="DrayTek-LAN-A"/>	<input type="text" value="LAN-A"/>	<input type="checkbox"/>	<input type="checkbox"/>	<input type="text" value="0"/>
2	<input checked="" type="checkbox"/>	<input type="checkbox"/>	<input type="text" value="DrayTek-LAN-B"/>	<input type="text" value="LAN-B"/>	<input type="checkbox"/>	<input type="checkbox"/>	<input type="text" value="0"/>
3	<input type="checkbox"/>	<input type="checkbox"/>	<input type="text"/>	<input type="text" value="LAN-A"/>	<input type="checkbox"/>	<input type="checkbox"/>	<input type="text" value="0"/>
4	<input type="checkbox"/>	<input type="checkbox"/>	<input type="text"/>	<input type="text" value="LAN-A"/>	<input type="checkbox"/>	<input type="checkbox"/>	<input type="text" value="0"/>

**Hide SSID:** Prevent SSID from being scanned.  
**Isolate LAN:** Wireless clients (stations) with the same SSID cannot access wired PCs on LAN.  
**Isolate Member:** Wireless clients (stations) with the same SSID cannot access for each other.  
**Isolate Exception:** Isolate Exception can be created by adding the MAC from [Device Object](#).

---

**WDS Settings (PHY Mode : HTMIX)**

<p>1. Subnet <input type="text" value="LAN-A"/></p> <p>Security : <input checked="" type="radio"/> Disabled <input type="radio"/> WEP <input type="radio"/> TKIP <input type="radio"/> AES</p> <p>Key : <input type="text"/></p> <p>Peer MAC Address : <input type="text" value=" : : : : :"/></p>	<p>3. Subnet <input type="text" value="LAN-A"/></p> <p>Security : <input checked="" type="radio"/> Disabled <input type="radio"/> WEP <input type="radio"/> TKIP <input type="radio"/> AES</p> <p>Key : <input type="text"/></p> <p>Peer MAC Address : <input type="text" value=" : : : : :"/></p>
<p>2. Subnet <input type="text" value="LAN-A"/></p> <p>Security : <input checked="" type="radio"/> Disabled <input type="radio"/> WEP <input type="radio"/> TKIP <input type="radio"/> AES</p> <p>Key : <input type="text"/></p> <p>Peer MAC Address : <input type="text" value=" : : : : :"/></p>	<p>4. Subnet <input type="text" value="LAN-A"/></p> <p>Security : <input checked="" type="radio"/> Disabled <input type="radio"/> WEP <input type="radio"/> TKIP <input type="radio"/> AES</p> <p>Key : <input type="text"/></p> <p>Peer MAC Address : <input type="text" value=" : : : : :"/></p>

**Note:** Enter the configuration of APs which AP810 want to connect.  
 Remote AP should always use LAN-A or SSID1 MAC address to connect AP810 WDS.

Available settings are explained as follows:

Item	Description
<b>Enable Wireless LAN</b>	Check the box to enable wireless function.
<b>Enable Client Limit</b>	Check the box to set the maximum number of wireless stations which try to connect Internet through Vigor AP. The number you can set is from 3 to 64.
<b>Enable Client Limit</b>	Define the maximum number of wireless stations per SSID

<b>per SSID</b>	which try to connect to Internet through Vigor device. The number you can set is from 3 to 64.
<b>Mode</b>	At present, VigorAP 810 can connect to 11b only, 11g only, 11n only, Mixed (11b+11g), Mixed (11g+11n) and Mixed (11b+11g+11n) stations simultaneously. Simply choose Mixed (11b+11g+11n) mode.
<b>Channel</b>	Means the channel of frequency of the wireless LAN. You may switch channel if the selected channel is under serious interference. If you have no idea of choosing the frequency, please select <b>AutoSelect</b> to let system determine for you.
<b>Extension Channel</b>	With 802.11n, there is one option to double the bandwidth per channel. The available extension channel options will be varied according to the <b>Channel</b> selected above. Configure the extension channel you want.
<b>Enable 2 Subnet (Simulate 2 APs)</b>	<p>Check the box to enable the function for two independent subnets. Once you enable this function, LAN-A and LAN-B would be independent. Next, you can connect one router in LAN-A, and another router in LAN-B. Such mechanism can make you feeling that you have two independent AP/subnet functions in one VigorAP 810.</p> <p>If you disable this function, LAN-A and LAN-B ports are in the same domain. You could only connect one router (no matter connecting to LAN-A or LAN-B) in this environment.</p>
<b>Enable</b>	SSID #1 is enabled in default. SSID #2 ~ #4 can be enabled manually.
<b>Hide SSID</b>	Check it to prevent from wireless sniffing and make it harder for unauthorized clients or STAs to join your wireless LAN. Depending on the wireless utility, the user may only see the information except SSID or just cannot see any thing about VigorAP 810 while site surveying. The system allows you to set three sets of SSID for different usage.
<b>SSID</b>	Set a name for VigorAP 810 to be identified. Default settings are DrayTek-LAN-A and DrayTek-LAN-B. When <b>Enable 2 Subnet</b> is enabled, you can specify subnet interface (LAN-A or LAN-B) for each SSID by using the drop down menu.
<b>Subnet</b>	Choose LAN-A or LAN-B for each SSID. If you choose LAN-A, the wireless clients connecting to this SSID could only communicate with LAN-A.
<b>Isolate LAN</b>	Check this box to make the wireless clients (stations) with the same SSID not accessing for wired PC in LAN.
<b>Isolate Member</b>	Check this box to make the wireless clients (stations) with the same SSID not accessing for each other.
<b>VLAN ID</b>	<p>Type the value for such SSID. Packets transferred from such SSID to LAN will be tagged with the number.</p> <p>If your network uses VLANs, you can assign the SSID to a VLAN on your network. Client devices that associate using the SSID are grouped into this VLAN. The VLAN ID range is</p>

	from 3 to 4095. The VLAN ID is 0 by default, it means disabling the VLAN function for the SSID.
<b>PHY Mode</b>	Data will be transmitted via HTMIX mode. Each access point should be setup to the same <b>PHY Mode</b> for connecting with each other.
<b>Subnet</b>	Choose LAN-A or LAN-B for each SSID.
<b>Security</b>	Select WEP, TKIP or AES as the encryption algorithm.
<b>Peer MAC Address</b>	Four peer MAC addresses are allowed to be entered in this page at one time.

After finishing this web page configuration, please click **OK** to save the settings.

### 3.8.2 Security

This page allows you to set security with different modes for SSID 1, 2, 3 and 4 respectively. After configuring the correct settings, please click **OK** to save and invoke it.

By clicking the **Security Settings**, a new web page will appear so that you could configure the settings.

Wireless LAN >> Security Settings

SSID 1	SSID 2	SSID 3	SSID 4
SSID			
DrayTek-LAN-A			
Mode			
WPA2 Personal			
Set up <a href="#">RADIUS Server</a> if 802.1x is enabled.			
<b>WPA</b>			
WPA Algorithms			
<input type="radio"/> TKIP <input checked="" type="radio"/> AES <input type="radio"/> TKIP/AES			
Pass Phrase			
.....			
Key Renewal Interval			
3600 seconds			
EAPOL Key Retry			
<input checked="" type="radio"/> Enable <input type="radio"/> Disable			
<b>WEP</b>			
<input type="radio"/> Key 1 : <input type="text"/> <input type="text"/> Hex			
<input checked="" type="radio"/> Key 2 : <input type="text"/> <input type="text"/> Hex			
<input type="radio"/> Key 3 : <input type="text"/> <input type="text"/> Hex			
<input type="radio"/> Key 4 : <input type="text"/> <input type="text"/> Hex			
<input type="button" value="OK"/> <input type="button" value="Cancel"/>			

Available settings are explained as follows:

Item	Description
<b>Mode</b>	<p>There are several modes provided for you to choose.</p> <p><u>Below shows the modes with higher security;</u></p> <p><b>WPA2 Personal, WPA2/WPA Personal</b> - Accepts only WPA clients and the encryption key should be entered in PSK. The WPA encrypts each frame transmitted from the radio using the key, which either PSK (Pre-Shared Key) entered manually in this field below or automatically negotiated via 802.1x authentication.</p> <p>The WPA encrypts each frame transmitted from the radio using the key, which either PSK (Pre-Shared Key) entered manually in this field below or automatically negotiated via 802.1x authentication. Select WPA, WPA2 or Auto as WPA mode.</p> <p><b>WPA2 Enterprise, WPA2/WPA Enterprise</b> - The WPA encrypts each frame transmitted from the radio using the key, which either PSK (Pre-Shared Key) entered manually in this field below or automatically negotiated via 802.1x authentication.</p> <p><u>Below shows the modes with basic security;</u></p> <p><b>WPA Personal</b> - Accepts only WPA clients and the encryption key should be entered in PSK. The WPA encrypts each frame</p>

	<p>transmitted from the radio using the key, which either PSK (Pre-Shared Key) entered manually in this field below or automatically negotiated via 802.1x authentication.</p> <p><b>WPA Enterprise</b> - The WPA encrypts each frame transmitted from the radio using the key, which either PSK (Pre-Shared Key) entered manually in this field below or automatically negotiated via 802.1x authentication.</p> <p><b>WEP Personal</b> - Accepts only WEP clients and the encryption key should be entered in WEP Key.</p> <p><b>None</b> - The encryption mechanism is turned off.</p>
<b>WPA Algorithms</b>	Select TKIP, AES or TKIP/AES as the algorithm for WPA. Such feature is available for <b>WPA2 Enterprise, WPA Enterprise, WPA Personal</b> or <b>WPA2/WPA Personal</b> mode.
<b>Pass Phrase</b>	Either <b>8~63</b> ASCII characters, such as 012345678..(or 64 Hexadecimal digits leading by 0x, such as "0x321253abcde..."). Such feature is available for <b>WPA Personal</b> or <b>WPA2 Personal</b> or <b>WPA2/WPA Personal</b> mode.
<b>Key Renewal Interval</b>	WPA uses shared key for authentication to the network. However, normal network operations use a different encryption key that is randomly generated. This randomly generated key that is periodically replaced. Enter the renewal security time (seconds) in the column. Smaller interval leads to greater security but lower performance. Default is 3600 seconds. Set 0 to disable re-key. Such feature is available for <b>WPA2 Enterprise, WPA Enterprise, WPA Personal</b> or <b>WPA2 Personal</b> or <b>WPA2/WPA Personal</b> mode.
<b>EAPOL Key Retry</b>	EAPOL means Extensible Authentication Protocol over LAN. <b>Enable</b> - The default setting is "Enable". It can make sure that the key will be installed and used once in order to prevent key reinstallation attack.
<b>Key 1 – Key 4</b>	Four keys can be entered here, but only one key can be selected at a time. The format of WEP Key is restricted to 5 ASCII characters or 10 hexadecimal values in 64-bit encryption level, or restricted to 13 ASCII characters or 26 hexadecimal values in 128-bit encryption level. The allowed content is the ASCII characters from 33(!) to 126(~) except '#' and ','. Such feature is available for <b>WEP Personal</b> mode.

Click the link of **RADIUS Server** to access into the following page for more settings.

Available settings are explained as follows:

Item	Description
<b>Use internal RADIUS Server</b>	<p>There is a RADIUS server built in VigorAP 810 which is used to authenticate the wireless client connecting to the access point. Check this box to use the internal RADIUS server for wireless security.</p> <p>Besides, if you want to use the external RADIUS server for authentication, do not check this box.</p> <p>Please refer to the section, <b>3.10 RADIUS Setting</b> to configure settings for internal server of VigorAP 810.</p>
<b>IP Address</b>	Enter the IP address of external RADIUS server.
<b>Port</b>	The UDP port number that the external RADIUS server is using. The default value is 1812, based on RFC 2138.
<b>Shared Secret</b>	The external RADIUS server and client share a secret that is used to authenticate the messages sent between them. Both sides must be configured to use the same shared secret.
<b>Session Timeout</b>	Set the maximum time of service provided before re-authentication. Set to zero to perform another authentication immediately after the first authentication has successfully completed. (The unit is second.)

After finishing this web page configuration, please click **OK** to save the settings.

### 3.8.3 Access Control

For additional security of wireless access, the **Access Control** facility allows you to restrict the network access right by controlling the wireless LAN MAC address of client. Only the valid MAC address that has been configured can access the wireless LAN interface. By clicking the **Access Control**, a new web page will appear, as depicted below, so that you could edit the clients' MAC addresses to control their access rights (deny or allow).

Wireless LAN >> Access Control

---

SSID 1	SSID 2	SSID 3	SSID 4						
SSID: SSID1 Policy: <input type="text" value="Disable"/>									
<b>MAC Address Filter</b>									
<table border="1"> <thead> <tr> <th>Index</th> <th>MAC Address</th> <th>access comment</th> </tr> </thead> <tbody> <tr> <td colspan="3" style="height: 100px;"> <div style="border: 1px solid gray; width: 100%; height: 100%;"></div> </td> </tr> </tbody> </table>				Index	MAC Address	access comment	<div style="border: 1px solid gray; width: 100%; height: 100%;"></div>		
Index	MAC Address	access comment							
<div style="border: 1px solid gray; width: 100%; height: 100%;"></div>									
<input type="radio"/> MAC <input checked="" type="radio"/> Object									
Device Group <input type="text" value="None"/> or Device Object <input type="text" value="None"/>									
<input type="button" value="Add"/> Limit: 256 entries									
<input type="button" value="OK"/> <input type="button" value="Cancel"/>									
Backup ACL Cfg : <input type="button" value="Backup"/>		Upload From File: <input type="button" value="選擇檔案"/> 未選擇任何檔案 <input type="button" value="Restore"/>							

Available settings are explained as follows:

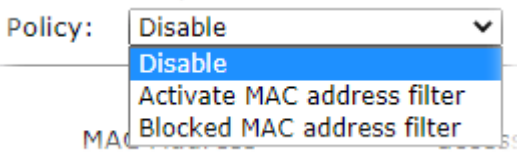
Item	Description
Policy	Select to enable any one of the following policy or disable the policy. Choose <b>Activate MAC address filter</b> to type in the MAC addresses for other clients in the network manually. Choose <b>Blocked MAC address filter</b> , so that all of the devices with the MAC addresses listed on the MAC Address Filter table will be blocked and cannot access into VigorAP 810.  
MAC Address Filter	Display all MAC addresses that are edited before.
MAC	<b>Client's MAC Address</b> - Manually enter the MAC address of wireless client. <b>Add</b> - Add a new MAC address into the list. <b>Delete</b> - Delete the selected MAC address in the list. <b>Edit</b> - Edit the selected MAC address in the list.

<b>Object</b>	In addition to enter the MAC address of the device manually, you can <b>Device Group</b> - Select one of the existed device groups and click <b>Add</b> . All the devices belonging to the selected group will be shown on the MAC Address Filter table. <b>Device Object</b> - Select one of the existed device object and click <b>Add</b> . The MAC address of the device will be shown on the MAC Address Filter table.
<b>Cancel</b>	Give up the access control set up.
<b>Backup</b>	Click it to store the settings (MAC addresses on MAC Address Filter table) on this page as a file.
<b>Restore</b>	Click it to restore the settings (MAC addresses on MAC Address Filter table) from an existed file.

After finishing this web page configuration, please click **OK** to save the settings.

### 3.8.4 WPS

Open **Wireless LAN>>WPS** to configure the corresponding settings.

Wireless LAN >> WPS (Wi-Fi Protected Setup)

Enable WPS 

Wi-Fi Protected Setup Information

WPS Configured	Yes
WPS SSID	DrayTek-LAN-A
WPS Auth Mode	WPA2 Personal
WPS Encrypt Type	AES

Device Configure

Configure via Push Button	<input type="button" value="Start PBC"/>
Configure via Client PinCode	<input type="text"/> <input type="button" value="Start PIN"/>

Status: Not used

**Note:** WPS can help your wireless client automatically connect to the Access point.

: WPS is Disabled.

: WPS is Enabled.

: Waiting for WPS requests from wireless clients.

Available settings are explained as follows:

Item	Description
<b>Enable WPS</b>	Check this box to enable WPS setting.
<b>WPS Configured</b>	Display related system information for WPS. If the wireless security (encryption) function of VigorAP 810 is properly configured, you can see 'Yes' message here.
<b>WPS SSID</b>	Display current selected SSID.
<b>WPS Auth Mode</b>	Display current authentication mode of the VigorAP 810r. Only WPA2/PSK and WPA/PSK support WPS.
<b>WPS Encrypt Type</b>	Display encryption mode (None, WEP, TKIP, AES, etc.) of VigorAP 810.



<b>Configure via Push Button</b>	Click <b>Start PBC</b> to invoke Push-Button style WPS setup procedure. VigorAP 810 will wait for WPS requests from wireless clients about two minutes. The WPS LED on VigorAP 810 will blink fast when WPS is in progress. It will return to normal condition after two minutes. (You need to setup WPS within two minutes)
<b>Configure via Client PinCode</b>	Type the PIN code specified in wireless client you wish to connect, and click <b>Start PIN</b> button. The WLAN LED on VigorAP 810 will blink fast when WPS is in progress. It will return to normal condition after two minutes. (You need to setup WPS within two minutes).

### 3.8.5 Advanced Setting

This page is to determine which algorithm will be selected for wireless transmission rate.

Wireless LAN >> Advanced Setting

Channel Bandwidth	<input type="radio"/> 20 MHz <input checked="" type="radio"/> Auto 20/40 MHz <input type="radio"/> 40 MHz
Packet-OVERDRIVE™ Tx Burst	<input type="radio"/> Enable <input checked="" type="radio"/> Disable (For 11g mode only)
Antenna	<input checked="" type="radio"/> 2T2R <input type="radio"/> 1T1R (1T1R would use the right antenna)
Tx Power	<input checked="" type="radio"/> 100% <input type="radio"/> 80% <input type="radio"/> 60% <input type="radio"/> 30% <input type="radio"/> 20% <input type="radio"/> 10%
Rate Adaptation Algorithm	<input checked="" type="radio"/> New <input type="radio"/> Old
Fragment Length (256 - 2346)	<input type="text" value="2346"/> bytes
RTS Threshold (1 - 2347)	<input type="text" value="2347"/> bytes
Country Code	<input type="text"/> (Reference)
Auto Channel Filtered Out List	<input type="checkbox"/> 1 <input type="checkbox"/> 2 <input type="checkbox"/> 3 <input type="checkbox"/> 4 <input type="checkbox"/> 5 <input type="checkbox"/> 6 <input type="checkbox"/> 7 <input type="checkbox"/> 8 <input type="checkbox"/> 9 <input type="checkbox"/> 10 <input type="checkbox"/> 11 <input type="checkbox"/> 12 <input type="checkbox"/> 13
IGMP Snooping	<input checked="" type="radio"/> Enable <input type="radio"/> Disable
WMM Capable	<input type="radio"/> Enable <input checked="" type="radio"/> Disable
MAC Clone	<input type="radio"/> Enable <input checked="" type="radio"/> Disable <input type="text"/>
<b>MAC Clone:</b>	Set the MAC address of SSIDs and the Wireless client. Please notice that the last byte of this MAC address must be a multiple of 8.

Available settings are explained as follows:

Item	Description
<b>Channel Bandwidth</b>	<p><b>20 MHZ-</b> the AP will use 20Mhz for data transmission and receiving between the AP and the stations.</p> <p><b>Auto 20/40 MHZ-</b> the AP will use 20Mhz or 40Mhz for data transmission and receiving according to the station capability. Such channel can increase the performance for data transmission.</p> <p><b>40 MHZ-</b> the AP will use 40Mhz for data transmission and receiving between the AP and the stations.</p>
<b>Packet-OVERDRIVE</b>	This feature can enhance the performance in data transmission about 40%* more (by checking <b>Tx Burst</b> ). It is active only when both sides of Access Point and Station (in wireless client) invoke this function at the same time. That is, the wireless client must support this feature and invoke the

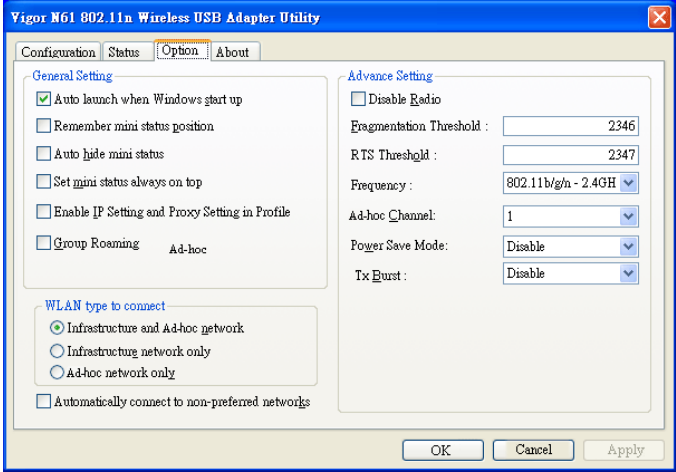
	<p>function, too.</p> <p><b>Note:</b> Vigor N61 wireless adapter supports this function. Therefore, you can use and install it into your PC for matching with Packet-OVERDRIVE (refer to the following picture of Vigor N61 wireless utility window, choose <b>Enable</b> for <b>TxBURST</b> on the tab of <b>Option</b>).</p> 
<b>Antenna</b>	VigorAP can be attached with two antennas to have good data transmission via wireless connection. However, if you have only one antenna attached, please choose 1T1R.
<b>Tx Power</b>	The default setting is the maximum (100%). Lowering down the value may degrade range and throughput of wireless.
<b>Rate Adaptation Algorithm</b>	Wireless transmission rate is adapted dynamically. Usually, performance of “new” algorithm is better than “old”.
<b>Fragment Length</b>	Set the Fragment threshold of wireless radio. Do not modify default value if you don't know what it is, default value is 2346.
<b>RTS Threshold</b>	<p>Minimize the collision (unit is bytes) between hidden stations to improve wireless performance.</p> <p>Set the RTS threshold of wireless radio. Do not modify default value if you don't know what it is, default value is 2347.</p>
<b>Country Code</b>	VigorAP broadcasts country codes by following the 802.11d standard. However, some wireless stations will detect / scan the country code to prevent conflict occurred. If conflict is detected, wireless station will be warned and is unable to make network connection. Therefore, changing the country code to ensure successful network connection will be necessary for some clients.
<b>Auto Channel Filtered Out List</b>	The selected wireless channels will be discarded if <b>AutoSelect</b> is selected as <b>Channel</b> selection mode in <b>Wireless LAN&gt;&gt;General Setup</b> .
<b>IGMP Snooping</b>	Check <b>Enable</b> to enable IGMP Snooping. Multicast traffic will be forwarded to ports that have members of that group. Disabling IGMP snooping will make multicast traffic treated in the same manner as broadcast traffic.
<b>WMM Capable</b>	To apply WMM parameters for wireless data transmission,

	please click the <b>Enable</b> radio button.
<b>MAC Clone</b>	Click <b>Enable</b> and manually enter the MAC address of the device with SSID 1. The MAC address of other SSIDs will change based on this MAC address.

After finishing this web page configuration, please click **OK** to save the settings.

### 3.8.6 AP Discovery

VigorAP 810 can scan all regulatory channels and find working APs in the neighborhood. Based on the scanning result, users will know which channel is clean for usage. Also, it can be used to facilitate finding an AP for a WDS link. Notice that during the scanning process (about 5 seconds), no client is allowed to connect to Vigor.

This page is used to scan the existence of the APs on the wireless LAN. Yet, only the AP which is in the same channel of VigorAP 810 can be found. Please click **Scan** to discover all the connected APs.

Wireless LAN >> Access Point Discovery

#### Access Point List

Enable AP Monitor Mode

Select	Index	SSID	BSSID	RSSI	Channel	Encryption	Authentication	Mode	Ch. Width
<input type="radio"/>	1	staffs	00:1d:aa:9c:fb:28	10%	1	TKIP/AES	Mixed(WPA+WPA2)/PSK	11b/g/n	20
<input type="radio"/>	2	staffs_5F...	00:1d:aa:f8:c9:c8	91%	1	TKIP/AES	Mixed(WPA+WPA2)/PSK	11b/g/n	20
<input type="radio"/>	3	guests_v29...	02:1d:aa:f8:c9:c8	91%	1	TKIP/AES	Mixed(WPA+WPA2)/PSK	11b/g/n	20
<input type="radio"/>	4	staffs_v29...	02:1d:aa:f9:c9:c8	91%	1	TKIP/AES	Mixed(WPA+WPA2)/PSK	11b/g/n	20
<input type="radio"/>	5	GRX350_24G...	00:e0:92:00:01:50	0%	1	AES	WPA2/PSK	11b/g/n	20
<input type="radio"/>	6	2860-cable	0a:1d:aa:b6:1b:b8	15%	1	NONE		11b/g/n	20
<input type="radio"/>	7	NodeMCU PQ...	00:1d:aa:86:ba:d0	10%	6	AES	WPA2/PSK	11b/g/n	20
<input type="radio"/>	8	v2860 PQC ...	02:1d:aa:86:ba:d0	20%	6	AES	WPA2/PSK	11b/g/n	20
<input type="radio"/>	9	NodeMCU PQ...	06:1d:aa:86:ba:d0	29%	6	TKIP/AES	Mixed(WPA+WPA2)/PSK	11b/g/n	20
<input type="radio"/>	10	NodeMCU PQ...	0a:1d:aa:86:ba:d0	20%	6	TKIP/AES	Mixed(WPA+WPA2)/PSK	11b/g/n	20
<input type="radio"/>	11	DrayTek	00:1d:aa:f7:c0:08	44%	6	NONE		11b/g/n	20
<input type="radio"/>	12	staffs	02:1d:aa:9c:f6:44	65%	6	TKIP/AES	Mixed(WPA+WPA2)/PSK	11b/g/n	20
<input type="radio"/>	13	guests	06:1d:aa:9c:f6:44	81%	6	TKIP/AES	Mixed(WPA+WPA2)/PSK	11b/g/n	20
<input type="radio"/>	14	staffs	02:1d:aa:9d:68:ac	39%	8	TKIP/AES	Mixed(WPA+WPA2)/PSK	11b/g/n	40
<input type="radio"/>	15	PQC APM Te...	00:50:7f:f0:d5:c0	5%	9	WEP		11b	20
<input type="radio"/>	16		02:50:7f:f0:d5:c0	0%	9	NONE		11b	20
<input type="radio"/>	17	PQC-APM-SS...	02:50:7f:f1:d5:c0	5%	9	NONE		11b	20
<input type="radio"/>	18	DrayTek_Ia...	00:1d:aa:00:00:00	70%	11	NONE		11b/g/n	20
<input type="radio"/>	19	DrayTek	00:1d:aa:74:da:38	44%	11	TKIP/AES	Mixed(WPA+WPA2)/PSK	11b/g/n	20
<input type="radio"/>	20	Draytek	00:1d:aa:80:06:b8	34%	11	TKIP/AES	Mixed(WPA+WPA2)/PSK	11b/g/n	20
<input type="radio"/>	21	DrayTek	00:1d:aa:f7:c0:f0	76%	11	NONE		11b/g/n	20
<input type="radio"/>	22	mars	00:1d:aa:e4:86:d8	29%	13	AES	WPA2/PSK	11b/g/n	20
<input type="radio"/>	23	Vigor2862-...	ff:ff:ff:66:77:64	100%	11	TKIP/AES	Mixed(WPA+WPA2)/PSK	11b/g/n	20
<input type="radio"/>	24	RD8_ACS_TE...	00:1d:aa:f7:a9:00	100%	11	TKIP/AES	Mixed(WPA+WPA2)/PSK	11b/g/n	20
<input type="radio"/>	25	DrayTek_V2...	00:1d:aa:f0:26:20	100%	11	TKIP/AES	Mixed(WPA+WPA2)/PSK	11b/g/n	40

Scan

See [Channel Interference](#)

**Note:** During the scanning process (about 5 seconds), no station is allowed to connect with the AP.

AP's MAC Address  :  :  :  :  :

AP's SSID

Add to WDS Settings:

Each item is explained as follows:

Item	Description
<b>Enable AP Monitor Mode</b>	<p>This function can help to get and keep the records of APs detected by such device after clicking Scan.</p> <p>In general, only the available AP will be detected by Vigor device. Once the AP is unavailable, it will be deleted from the Access Point List immediately. However, if such function is enabled, the system will keep the record of the AP (once</p>

	detected by Vigor device) until it is available for Vigor device again.
<b>SSID</b>	Display the SSID of the AP scanned by VigorAP 810.
<b>BSSID</b>	Display the MAC address of the AP scanned by VigorAP 810.
<b>RSSI</b>	Display the signal strength of the access point. RSSI is the abbreviation of Receive Signal Strength Indication.
<b>Channel</b>	Display the wireless channel used for the AP that is scanned by VigorAP 810.
<b>Encryption</b>	Display the encryption mode for the scanned AP.
<b>Authentication</b>	Display the authentication type that the scanned AP applied.
<b>Mode</b>	Display the wireless connection mode that the scanned AP used.
<b>Ch. Width</b>	Display the channel width that the scanned AP used.
<b>Scan</b>	It is used to discover all the connected AP. The results will be shown on the box above this button
<b>Channel Statistics</b>	It displays the statistics for the channels used by APs.
<b>AP's MAC Address</b>	If you want the found AP applying the WDS settings, please type in the AP's MAC address.
<b>AP's SSID</b>	To specify an AP to be applied with WDS settings, you can specify MAC address or SSID for the AP. Here is the place that you can type the SSID of the AP.
<b>Add</b>	Click <b>Repeater</b> for the specified AP. Next, click <b>Add</b> . Later, the MAC address of the AP will be added and be shown on WDS settings page.

### 3.8.7 WDS AP Status

VigorAP 810 can display the status such as MAC address, physical mode, power save and bandwidth for the working AP connected with WDS. Click **Refresh** to get the newest information.

Wireless LAN >> WDS AP Status

#### WDS AP List

AID	MAC Address	802.11 Physical Mode	Power Save	Bandwidth
1	00:50:7F:C9:76:0C	CCK	OFF	20M

Refresh

### 3.8.8 Bandwidth Management

The downstream or upstream from FTP, HTTP or some P2P applications will occupy large of bandwidth and affect the applications for other programs. Please use Bandwidth Management to make the bandwidth usage more efficient.

Wireless LAN >> Bandwidth Management

SSID 1	SSID 2	SSID 3	SSID 4
SSID DrayTek-LAN-A			
Per Station Bandwidth Limit			
Enable	<input checked="" type="checkbox"/>		
Upload Limit	User defined ▾	K	bps (Default unit : K)
Download Limit	User defined ▾	K	bps (Default unit : K)
Auto Adjustment	<input checked="" type="checkbox"/>		
Total Upload Limit	User defined ▾	K	bps (Default unit : K)
Total Download Limit	User defined ▾	K	bps (Default unit : K)

Note: 1. Download : Traffic going to any station. Upload : Traffic being sent from a wireless station.  
2. Allow auto adjustment could make the best utilization of available bandwidth.

OK Cancel

Available settings are explained as follows:

Item	Description
<b>SSID</b>	Display the specific SSID name of the AP.
<b>Enable</b>	Check this box to enable the bandwidth management for clients.
<b>Upload Limit</b>	Define the maximum speed of the data uploading which will be used for the wireless stations connecting to Vigor AP with the same SSID. Use the drop down list to choose the rate. If you choose <b>User defined</b> , you have to specify the rate manually.
<b>Download Limit</b>	Define the maximum speed of the data downloading which will be used for the wireless station connecting to Vigor AP with the same SSID. Use the drop down list to choose the rate. If you choose <b>User defined</b> , you have to specify the rate manually.
<b>Auto Adjustment</b>	Check this box to have the bandwidth limit determined by the system automatically.
<b>Total Upload Limit</b>	When Auto Adjustment is checked, the value defined here will be treated as the total bandwidth shared by all of the wireless stations with the same SSID for data uploading.
<b>Total Download Limit</b>	When Auto Adjustment is checked, the value defined here will be treated as the total bandwidth shared by all of the wireless stations with the same SSID for data downloading.

After finishing this web page configuration, please click **OK** to save the settings.

### 3.8.9 Airtime Fairness

Airtime fairness is essential in wireless networks that must support critical enterprise applications.

Most of the applications are either symmetric or require more downlink than uplink capacity; telephony and email send the same amount of data in each direction, while video streaming and web surfing involve more traffic sent from access points to clients than the other way around. This is essential for ensuring predictable performance and quality-of-service, as well as allowing 802.11n and legacy clients to coexist on the same network. Without airtime fairness, offices using mixed mode networks risk having legacy clients slow down the entire network or letting the fastest client(s) crowd out other users.

With airtime fairness, every client at a given quality-of-service level has equal access to the network's airtime.

The wireless channel can be accessed by only one wireless station at the same time.

The principle behind the IEEE802.11 channel access mechanisms is that each station has **equal probability** to access the channel. When wireless stations have similar data rate, this principle leads to a fair result. In this case, stations get similar channel access time which is called airtime.

However, when stations have various data rate (e.g., 11g, 11n), the result is not fair. The slow stations (11g) work in their slow data rate and occupy too much airtime, whereas the fast stations (11n) become much slower.

Take the following figure as an example, both Station A(11g) and Station B(11n) transmit data packets through VigorAP 810. Although they have equal probability to access the wireless channel, Station B(11n) gets only a little airtime and waits too much because Station A(11g) spends longer time to send one packet. In other words, Station B(fast rate) is obstructed by Station A(slow rate).

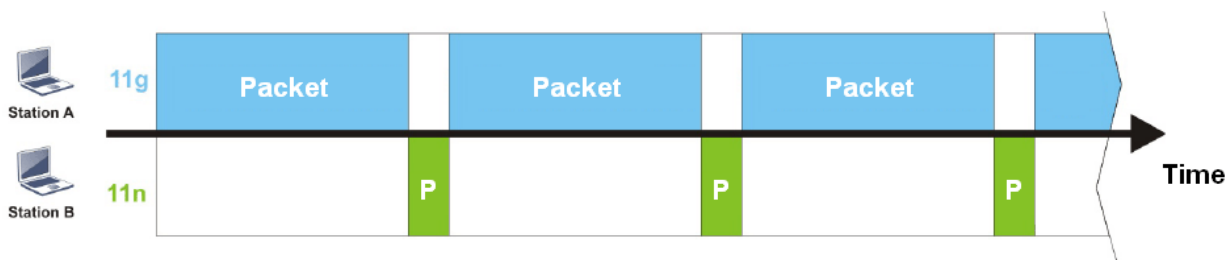

To improve this problem, Airtime Fairness is added for VigorAP 810. Airtime Fairness function tries to assign *similar airtime* to each station (A/B) by controlling TX traffic. In the following figure, Station B(11n) has higher probability to send data packets than Station A(11g). By this way, Station B(fast rate) gets fair airtime and it's speed is not limited by Station A(slow rate).



It is similar to automatic Bandwidth Limit. The dynamic bandwidth limit of each station depends on instant active station number and airtime assignment. Please note that Airtime Fairness of 2.4GHz and 5GHz are independent. But stations of different SSIDs function together, because they all use the same wireless channel. IN SPECIFIC ENVIRONMENTS, this function can reduce the bad influence of slow wireless devices and improve the overall wireless performance.

Suitable environment:

- (1) Many wireless stations.
- (2) All stations mainly use download traffic.
- (3) The performance bottleneck is wireless connection.

#### Wireless LAN >> Airtime Fairness

Enable **Airtime Fairness**  
 Triggering Client Number  (2 ~ 64, Default: 2)

**Note:** Please enable or disable this function according to the real situation and user experience. It is NOT suitable for all environments. You could check [Diagnostics >> Station Airtime](#) Graph first.

Available settings are explained as follows:

Item	Description
<b>Enable Airtime Fairness</b>	<p>Try to assign similar airtime to each wireless station by controlling TX traffic.</p> <p><b>Airtime Fairness</b> – Click the link to display the following screen of airtime fairness note.</p> <p><b>Triggering Client Number</b> – Airtime Fairness function is applied only when active station number achieves this number.</p>

After finishing this web page configuration, please click **OK** to save the settings.

**Note:** Airtime Fairness function and Bandwidth Limit function should be mutually exclusive. So their webs have extra actions to ensure these two functions are not enabled simultaneously.

### 3.8.10 Station Control

Station Control is used to specify the duration for the wireless client to connect and reconnect VigorAP. If such function is not enabled, the wireless client can connect VigorAP until it shuts down.

Such feature is especially useful for free Wi-Fi service. For example, a coffee shop offers free Wi-Fi service for its guests for one hour every day. Then, the connection time can be set as “1 hour” and reconnection time can be set as “1 day”. Thus, the guest can finish his job within one hour and will not occupy the wireless network for a long time.

**Note:** Up to 300 Wireless Station records are supported by VigorAP.

Wireless LAN >> Station Control

SSID 1	SSID 2	SSID 3	SSID 4
SSID	DrayTek-LAN-A		
Enable	<input checked="" type="checkbox"/>		
Connection Time	1 hour		
Reconnection Time	1 day		
<a href="#">Display All Station Control List</a>			

**Note:** Once the feature is enabled, the connection time quota will apply to each wireless client (identified by MAC address).

OK Cancel

Available settings are explained as follows:

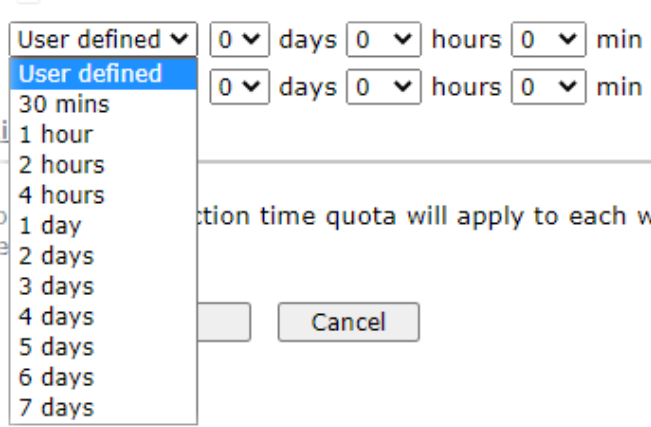
Item	Description
<b>SSID</b>	Display the SSID that the wireless station will use it to connect with Vigor router.
<b>Enable</b>	Check the box to enable the station control function.
<b>Connection Time / Reconnection Time</b>	Use the drop down list to choose the duration for the wireless client connecting /reconnecting to Vigor router. Or, type the duration manually when you choose <b>User defined</b> . 



<b>Display All Station Control List</b>	All the wireless stations connecting to Vigor router by using such SSID will be listed on Station Control List.
---	---

After finishing all the settings here, please click **OK** to save the configuration.

### 3.8.11 Roaming

The network signal for a single wireless access point might be limited by its coverage range. Therefore, if you want to expand the wireless network in a large exhibition with a quick method, you can install multiple access points with enabling the Roaming feature for each AP to reach the purpose of expanding wireless signals seamlessly.

These access points connecting for each other shall be verified by pre-authentication. This page allows you to enable the roaming feature and the pre-authentication.

#### Wireless LAN >> Roaming

##### AP-assisted Client Roaming Parameters

<input type="checkbox"/> <b>Minimum Basic Rate</b>	1	Mbps
<input checked="" type="radio"/> <b>Disable RSSI Requirement</b>		
<input type="radio"/> <b>Strictly Minimum RSSI</b>	-73	dBm (42%) (Default: -73)
<input type="radio"/> <b>Minimum RSSI</b>	-66	dBm (60%) (Default: -66)
with Adjacent AP RSSI over	5	dB (Default: 5)

##### Fast Roaming(WPA2 Enterprise)

<input type="checkbox"/> <b>Enable</b>	
<b>PMK Caching</b> : Cache Period	10 minutes (10 ~ 600, Default: 10)
<b>Pre-Authentication</b>	

OK Cancel

Available settings are explained as follows:

Item	Description
<b>AP-assisted Client Roaming Parameters</b>	<p>When the link rate of wireless station is too low or the signal received by the wireless station is too worse, VigorAP 810 will automatically detect (based on the link rate and RSSI requirement) and cut off the network connection for that wireless station to assist it to connect another Wireless AP to get better signal.</p> <p><b>Minimum Basic Rate</b> – Check the box to use the drop down list to specify a basic rate (<b>Mbps</b>). When the link rate of the wireless station is below such value, VigorAP 810 will terminate the network connection for that wireless station.</p> <p><b>Disable RSSI Requirement</b> - If it is selected, VigorAP will not terminate the network connection based on RSSI.</p> <p><b>Strictly Minimum RSSI</b> - VigorAP uses RSSI (received signal strength indicator) to decide to terminate the network connection of wireless station. When the signal strength is below the value (<b>dBm</b>) set here, VigorAP 810 will terminate the network connection for that wireless station.</p> <p><b>Minimum RSSI</b> - When the signal strength of the wireless</p>

	<p>station is below the value (<b>dBm</b>) set here and adjacent AP (must be DrayTek AP and support such feature too) with higher signal strength value (defined in the field of <b>With Adjacent AP RSSI over</b>) is detected by VigorAP 810, VigorAP 810 will terminate the network connection for that wireless station. Later, the wireless station can connect to the adjacent AP (with better RSSI).</p> <ul style="list-style-type: none"> <li>● <b>With Adjacent AP RSSI over</b> – Specify a value as a threshold.</li> </ul>
<p><b>Fast Roaming (WPA/802.1x)</b></p>	<p><b>Enable</b> – Check the box to enable fast roaming configuration.</p> <p><b>PMK Cache Period</b> - Set the expire time of WPA2 PMK (Pairwise master key) cache. PMK Cache manages the list from the BSSIDs in the associated SSID with which it has pre-authenticated. Such feature is available for <b>WPA2/802.1</b> mode.</p> <p><b>Pre-Authentication</b> - Enables a station to authenticate to multiple APs for roaming securer and faster. With the pre-authentication procedure defined in IEEE 802.11i specification, the pre-four-way-handshake can reduce handoff delay perceivable by a mobile node. It makes roaming faster and more secure. (Only valid in WPA2)</p> <p><b>Enable</b> - Enable IEEE 802.1X Pre-Authentication.</p> <p><b>Disable</b> - Disable IEEE 802.1X Pre-Authentication.</p>

After finishing this web page configuration, please click **OK** to save the settings.

### 3.8.12 Station List

**Station List** provides the knowledge of connecting wireless clients now along with its status code.

Wireless LAN (2.4GHz) >> Station List

Station List

		General	Advanced	Control	Neighbor
Index	MAC Address	RSSI	Approx. Distance	SSID	Visit Time
1	dc:85:de:03:fb:6f	73%	6.31m	N/A	0d:1h:26m:11s
2	80:86:f2:8f:d4:91	78%	5.01m	N/A	0d:7h:0m:8s
3	b4:ce:f6:25:03:e1	100%	1.58m	N/A	0d:0h:0m:0s
4	44:2a:60:80:15:d6	86%	3.55m	N/A	0d:14h:2m:26s
5	84:7a:88:79:41:01	31%	39.81m	N/A	0d:0h:2m:56s
6	5c:ff:35:84:d9:ba	52%	15.85m	N/A	0d:8h:18m:1s
7	00:1d:aa:7e:84:38	100%	0.20m	N/A	0d:0h:0m:0s
8	f4:f1:5a:8a:e8:b9	83%	3.98m	N/A	0d:0h:0m:1s
9	50:2e:5c:29:43:e6	20%	70.79m	N/A	0d:0h:0m:5s

Refresh

Add to **Access Control** :

Client's MAC Address :  :  :  :  :  :

Available settings are explained as follows:

Item	Description
<b>MAC Address</b>	Display the MAC Address for the connecting client.
<b>SSID</b>	Display the SSID that the wireless client connects to.
<b>Auth</b>	Display the authentication that the wireless client uses for connection with such AP.
<b>Encrypt</b>	Display the encryption mode used by the wireless client.
<b>Tx Rate/Rx Rate</b>	Display the transmission /receiving rate for packets.
<b>Refresh</b>	Click this button to refresh the status of station list.
<b>Add to Access Control</b>	<b>Client's MAC Address</b> - For additional security of wireless access, the Access Control facility allows you to restrict the network access right by controlling the wireless LAN MAC address of client. Only the valid MAC address that has been configured can access the wireless LAN interface.
<b>Add</b>	Click this button to add current typed MAC address into <b>Access Control</b> .

#### General

Display general information (e.g., MAC Address, SSID, Auth, Encrypt, TX/RX Rate) for the station.

#### Advanced

Display more information (e.g., AID, PSM, WMM, RSSI PhMd, BW, MCS, Rate) for the station.

#### Control

Display connection and reconnection time of the wireless stations.

## Neighbor

Display more information for the neighboring wireless stations.

### 3.9 Wireless LAN Settings for Universal Repeater Mode

When you choose Universal Repeater as the operation mode, the Wireless LAN menu items will include General Setup, Security, WPS, AP Discovery, Universal Repeater, Bandwidth Management, Airtime Fairness, Station Control, Roaming and Station List.



### 3.9.1 General Setup

By clicking the **General Setup**, a new web page will appear so that you could configure the SSID and the wireless channel.

Please refer to the following figure for more information.

Wireless LAN >> General Setup

General Setting ( IEEE 802.11 )

Enable Wireless LAN

Enable Client Limit  (3 ~ 64, default: 64)

Enable Client Limit per SSID (3 ~ 64, default: 64)

---

Mode :  ▼

Channel :  ▼

Extension Channel :  ▼

---

Enable 2 Subnet (Simulate 2 APs)

	Enable	Hide SSID	SSID	Subnet	Isolate LAN	Isolate Member	VLAN ID (0:Untagged)
1	<input type="checkbox"/>	<input type="checkbox"/>	<input type="text" value="DrayTek-LAN-A"/>	<input type="text" value="LAN-A"/> ▼	<input type="checkbox"/>	<input type="checkbox"/>	<input type="text" value="0"/>
2	<input checked="" type="checkbox"/>	<input type="checkbox"/>	<input type="text" value="DrayTek-LAN-B"/>	<input type="text" value="LAN-B"/> ▼	<input type="checkbox"/>	<input type="checkbox"/>	<input type="text" value="0"/>
3	<input type="checkbox"/>	<input type="checkbox"/>	<input type="text"/>	<input type="text" value="LAN-A"/> ▼	<input type="checkbox"/>	<input type="checkbox"/>	<input type="text" value="0"/>
4	<input type="checkbox"/>	<input type="checkbox"/>	<input type="text"/>	<input type="text" value="LAN-A"/> ▼	<input type="checkbox"/>	<input type="checkbox"/>	<input type="text" value="0"/>

Hide SSID: Prevent SSID from being scanned.

Isolate LAN: Wireless clients (stations) with the same SSID cannot access wired PCs on LAN.

Isolate Member: Wireless clients (stations) with the same SSID cannot access for each other.

Isolate Exception: Isolate Exception can be created by adding the MAC from Device Object.

Available settings are explained as follows:

Item	Description
<b>Enable Wireless LAN</b>	Check the box to enable wireless function.
<b>Enable Client Limit</b>	Check the box to set the maximum number of wireless stations which try to connect Internet through Vigor AP. The number you can set is from 3 to 64.
<b>Enable Client Limit per SSID</b>	Define the maximum number of wireless stations per SSID which try to connect to Internet through Vigor device. The number you can set is from 3 to 64.
<b>Mode</b>	At present, VigorAP 810 can connect to 11b only, 11g only, 11n only, Mixed (11b+11g), Mixed (11g+11n) and Mixed (11b+11g+11n) stations simultaneously. Simply choose Mixed (11b+11g+11n) mode.
<b>Channel</b>	Means the channel of frequency of the wireless LAN. You may switch channel if the selected channel is under serious interference. If you have no idea of choosing the frequency, please select <b>AutoSelect</b> to let system determine for you.
<b>Rate</b>	If you choose 11g Only or 11b Only, such feature will be available for you to set data transmission rate.

<b>Extension Channel</b>	With 802.11n, there is one option to double the bandwidth per channel. The available extension channel options will be varied according to the <b>Channel</b> selected above. Configure the extension channel you want.
<b>Enable 2 Subnet (Simulate 2 APs)</b>	<p>Check the box to enable the function for two independent subnets. Once you enable this function, LAN-A and LAN-B would be independent. Next, you can connect one router in LAN-A, and another router in LAN-B. Such mechanism can make you feeling that you have two independent AP/subnet functions in one VigorAP 810.</p> <p>If you disable this function, LAN-A and LAN-B ports are in the same domain. You could only connect one router (no matter connecting to LAN-A or LAN-B) in this environment.</p>
<b>Enable</b>	SSID #1 is enabled in default. SSID #2 ~ #4 can be enabled manually.
<b>Hide SSID</b>	Check it to prevent from wireless sniffing and make it harder for unauthorized clients or STAs to join your wireless LAN. Depending on the wireless utility, the user may only see the information except SSID or just cannot see any thing about VigorAP 810 while site surveying. The system allows you to set three sets of SSID for different usage.
<b>SSID</b>	Set a name for VigorAP 810 to be identified. Default settings are DrayTek-LAN-A and DrayTek-LAN-B. When <b>Enable 2 Subnet</b> is enabled, you can specify subnet interface (LAN-A or LAN-B) for each SSID by using the drop down menu.
<b>Subnet</b>	Choose LAN-A or LAN-B for each SSID. If you choose LAN-A, the wireless clients connecting to this SSID could only communicate with LAN-A.
<b>Isolate LAN</b>	Check this box to make the wireless clients (stations) with the same SSID not accessing for wired PC in LAN.
<b>Isolate Member</b>	Check this box to make the wireless clients (stations) with the same SSID not accessing for each other.
<b>VLAN ID</b>	<p>Type the value for such SSID. Packets transferred from such SSID to LAN will be tagged with the number.</p> <p>If your network uses VLANs, you can assign the SSID to a VLAN on your network. Client devices that associate using the SSID are grouped into this VLAN. The VLAN ID range is from 3 to 4095. The VLAN ID is 0 by default, it means disabling the VLAN function for the SSID.</p>

After finishing this web page configuration, please click **OK** to save the settings.

### 3.9.2 Security

This page allows you to set security with different modes for SSID 1, 2, 3 and 4 respectively. After configuring the correct settings, please click **OK** to save and invoke it.

By clicking the **Security Settings**, a new web page will appear so that you could configure the settings.

Wireless LAN >> Security Settings

SSID 1	SSID 2	SSID 3	SSID 4
SSID		DrayTek-LAN-A	
Mode		WPA2 Personal	
Set up <b>RADIUS Server</b> if 802.1x is enabled.			
<b>WPA</b>			
WPA Algorithms		<input type="radio"/> TKIP <input checked="" type="radio"/> AES <input type="radio"/> TKIP/AES	
Pass Phrase		<input type="password" value="....."/>	
Key Renewal Interval		<input type="text" value="3600"/> seconds	
EAPOL Key Retry		<input checked="" type="radio"/> Enable <input type="radio"/> Disable	
<b>WEP</b>			
<input type="radio"/> Key 1 :	<input type="text"/>	<input type="text"/>	Hex
<input checked="" type="radio"/> Key 2 :	<input type="text"/>	<input type="text"/>	Hex
<input type="radio"/> Key 3 :	<input type="text"/>	<input type="text"/>	Hex
<input type="radio"/> Key 4 :	<input type="text"/>	<input type="text"/>	Hex

Available settings are explained as follows:

Item	Description
<b>Mode</b>	<p>There are several modes provided for you to choose.</p> <p><u>Below shows the modes with higher security;</u></p> <p><b>WPA2 Personal, WPA2/WPA Personal</b> - Accepts only WPA clients and the encryption key should be entered in PSK. The WPA encrypts each frame transmitted from the radio using the key, which either PSK (Pre-Shared Key) entered manually in this field below or automatically negotiated via 802.1x authentication.</p> <p>The WPA encrypts each frame transmitted from the radio using the key, which either PSK (Pre-Shared Key) entered manually in this field below or automatically negotiated via 802.1x authentication. Select WPA, WPA2 or Auto as WPA mode.</p> <p><b>WPA2 Enterprise, WPA2/WPA Enterprise</b> - The WPA encrypts each frame transmitted from the radio using the key, which either PSK (Pre-Shared Key) entered manually in this field below or automatically negotiated via 802.1x authentication.</p> <p><u>Below shows the modes with basic security;</u></p> <p><b>WPA Personal</b> - Accepts only WPA clients and the encryption key should be entered in PSK. The WPA encrypts each frame transmitted from the radio using the key, which either PSK</p>

	<p>(Pre-Shared Key) entered manually in this field below or automatically negotiated via 802.1x authentication.</p> <p><b>WPA Enterprise</b> - The WPA encrypts each frame transmitted from the radio using the key, which either PSK (Pre-Shared Key) entered manually in this field below or automatically negotiated via 802.1x authentication.</p> <p><b>WEP Personal</b> - Accepts only WEP clients and the encryption key should be entered in WEP Key.</p> <p><b>None</b> - The encryption mechanism is turned off.</p>
<b>WPA Algorithms</b>	<p>Select TKIP, AES or TKIP/AES as the algorithm for WPA. Such feature is available for <b>WPA2 Enterprise, WPA Enterprise, WPA Personal</b> or <b>WPA2 Personal</b> or <b>WPA2/WPA Personal</b> mode.</p>
<b>Pass Phrase</b>	<p>Either <b>8~63</b> ASCII characters, such as 012345678..(or 64 Hexadecimal digits leading by 0x, such as "0x321253abcde..."). Such feature is available for <b>WPA Personal</b> or <b>WPA2 Personal</b> or <b>WPA2/WPA Personal</b> mode.</p>
<b>Key Renewal Interval</b>	<p>WPA uses shared key for authentication to the network. However, normal network operations use a different encryption key that is randomly generated. This randomly generated key that is periodically replaced. Enter the renewal security time (seconds) in the column. Smaller interval leads to greater security but lower performance. Default is 3600 seconds. Set 0 to disable re-key. Such feature is available for <b>WPA2 Enterprise, WPA Enterprise, WPA Personal</b> or <b>WPA2 Personal</b> or <b>WPA2/WPA Personal</b> mode.</p>
<b>EAPOL Key Retry</b>	<p>EAPOL means Extensible Authentication Protocol over LAN.</p> <p><b>Enable</b> - The default setting is "Enable". It can make sure that the key will be installed and used once in order to prevent key reinstallation attack.</p>
<b>Key 1 – Key 4</b>	<p>Four keys can be entered here, but only one key can be selected at a time. The format of WEP Key is restricted to 5 ASCII characters or 10 hexadecimal values in 64-bit encryption level, or restricted to 13 ASCII characters or 26 hexadecimal values in 128-bit encryption level. The allowed content is the ASCII characters from 33(!) to 126(~) except '#' and ','. Such feature is available for <b>WEP</b> mode.</p>

Click the link of **RADIUS Server** to access into the following page for more settings.



Available settings are explained as follows:

Item	Description
<b>Use internal RADIUS Server</b>	<p>There is a RADIUS server built in VigorAP 810 which is used to authenticate the wireless client connecting to the access point. Check this box to use the internal RADIUS server for wireless security.</p> <p>Besides, if you want to use the external RADIUS server for authentication, do not check this box.</p> <p>Please refer to the section, <b>3.10 RADIUS Setting</b> to configure settings for internal server of VigorAP 810.</p>
<b>IP Address</b>	Enter the IP address of external RADIUS server.
<b>Port</b>	The UDP port number that the external RADIUS server is using. The default value is 1812, based on RFC 2138.
<b>Shared Secret</b>	The external RADIUS server and client share a secret that is used to authenticate the messages sent between them. Both sides must be configured to use the same shared secret.
<b>Session Timeout</b>	Set the maximum time of service provided before re-authentication. Set to zero to perform another authentication immediately after the first authentication has successfully completed. (The unit is second.)

After finishing this web page configuration, please click **OK** to save the settings.

### 3.9.3 Access Control

For additional security of wireless access, the **Access Control** facility allows you to restrict the network access right by controlling the wireless LAN MAC address of client. Only the valid MAC address that has been configured can access the wireless LAN interface. By clicking the **Access Control**, a new web page will appear, as depicted below, so that you could edit the clients' MAC addresses to control their access rights (deny or allow).

Wireless LAN >> Access Control

---

SSID 1	SSID 2	SSID 3	SSID 4									
SSID: DrayTek-LAN-A Policy: <span>Disable</span>												
<table border="1"> <thead> <tr> <th colspan="3">MAC Address Filter</th> </tr> <tr> <th>Index</th> <th>MAC Address</th> <th>access comment</th> </tr> </thead> <tbody> <tr> <td colspan="3" style="height: 100px;"></td> </tr> </tbody> </table>				MAC Address Filter			Index	MAC Address	access comment			
MAC Address Filter												
Index	MAC Address	access comment										
<input checked="" type="radio"/> MAC <input type="radio"/> Object Client's MAC Address : <input type="text"/> : <input type="text"/> : <input type="text"/> : <input type="text"/> : <input type="text"/> : <input type="text"/>												
<input type="button" value="Add"/> <input type="button" value="Delete"/> <input type="button" value="Edit"/> Limit: 256 entries												
<input type="button" value="OK"/> <input type="button" value="Cancel"/>												
Backup ACL Cfg : <input type="button" value="Backup"/>		Upload From File: <span>選擇檔案</span> <span>未選擇任何檔案</span> <input type="button" value="Restore"/>										

Available settings are explained as follows:

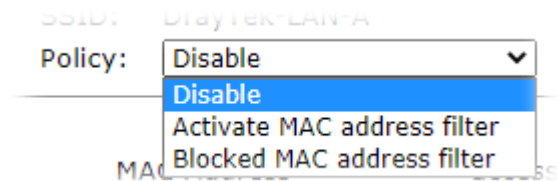
Item	Description
<b>Policy</b>	Select to enable any one of the following policy or disable the policy. Choose <b>Activate MAC address filter</b> to type in the MAC addresses for other clients in the network manually. Choose <b>Blocked MAC address filter</b> , so that all of the devices with the MAC addresses listed on the MAC Address Filter table will be blocked and cannot access into VigorAP 810. 
<b>MAC Address Filter</b>	Display all MAC addresses that are edited before.
<b>MAC</b>	<b>Client's MAC Address</b> - Manually enter the MAC address of wireless client. <b>Add</b> - Add a new MAC address into the list. <b>Delete</b> - Delete the selected MAC address in the list. <b>Edit</b> - Edit the selected MAC address in the list.
<b>Object</b>	In addition to enter the MAC address of the device manually,

	<p>you can</p> <p><b>Device Group</b> - Select one of the existed device groups and click <b>Add</b>. All the devices belonging to the selected group will be shown on the MAC Address Filter table.</p> <p><b>Device Object</b> - Select one of the existed device object and click <b>Add</b>. The MAC address of the device will be shown on the MAC Address Filter table.</p>
<b>Cancel</b>	Give up the access control set up.
<b>Backup</b>	Click it to store the settings (MAC addresses on MAC Address Filter table) on this page as a file.
<b>Restore</b>	Click it to restore the settings (MAC addresses on MAC Address Filter table) from an existed file.

After finishing this web page configuration, please click **OK** to save the settings.

### 3.9.4 WPS

Open **Wireless LAN>>WPS** to configure the corresponding settings.

Wireless LAN >> WPS (Wi-Fi Protected Setup)

Enable WPS 

Wi-Fi Protected Setup Information

WPS Configured	Yes
WPS SSID	DrayTek-LAN-A
WPS Auth Mode	WPA2 Personal
WPS Encrypt Type	AES

Device Configure

Configure via Push Button	<input type="button" value="Start PBC"/>
Configure via Client PinCode	<input type="text"/> <input type="button" value="Start PIN"/>

Status: Not used

**Note:** WPS can help your wireless client automatically connect to the Access point.

: WPS is Disabled.

: WPS is Enabled.

: Waiting for WPS requests from wireless clients.

Available settings are explained as follows:

Item	Description
<b>Enable WPS</b>	Check this box to enable WPS setting.
<b>WPS Configured</b>	Display related system information for WPS. If the wireless security (encryption) function of VigorAP 810 is properly configured, you can see 'Yes' message here.
<b>WPS SSID</b>	Display current selected SSID.
<b>WPS Auth Mode</b>	Display current authentication mode of the VigorAP 810. Only WPA2/PSK and WPA/PSK support WPS.
<b>WPS Encrypt Type</b>	Display encryption mode (None, WEP, TKIP, AES, etc.) of VigorAP 810.
<b>Configure via Push</b>	Click <b>Start PBC</b> to invoke Push-Button style WPS setup

<b>Button</b>	procedure. VigorAP 810 will wait for WPS requests from wireless clients about two minutes. The WPS LED on VigorAP 810 will blink fast when WPS is in progress. It will return to normal condition after two minutes. (You need to setup WPS within two minutes)
<b>Configure via Client PinCode</b>	Type the PIN code specified in wireless client you wish to connect, and click <b>Start PIN</b> button. The WLAN LED on VigorAP 810 will blink fast when WPS is in progress. It will return to normal condition after two minutes. (You need to setup WPS within two minutes).

### 3.9.5 Advanced Setting

This page is to determine which algorithm will be selected for wireless transmission rate.

Wireless LAN >> Advanced Setting

Channel Bandwidth	<input type="radio"/> 20 MHz <input checked="" type="radio"/> Auto 20/40 MHz <input type="radio"/> 40 MHz
Packet-OVERDRIVE™ Tx Burst	<input type="radio"/> Enable <input checked="" type="radio"/> Disable (For 11g mode only)
Antenna	<input checked="" type="radio"/> 2T2R <input type="radio"/> 1T1R (1T1R would use the right antenna)
Tx Power	<input checked="" type="radio"/> 100% <input type="radio"/> 80% <input type="radio"/> 60% <input type="radio"/> 30% <input type="radio"/> 20% <input type="radio"/> 10%
Rate Adaptation Algorithm	<input checked="" type="radio"/> New <input type="radio"/> Old
Fragment Length (256 - 2346)	<input type="text" value="2346"/> bytes
RTS Threshold (1 - 2347)	<input type="text" value="2347"/> bytes
Country Code	<input type="text"/> (Reference)
Auto Channel Filtered Out List	<input type="checkbox"/> 1 <input type="checkbox"/> 2 <input type="checkbox"/> 3 <input type="checkbox"/> 4 <input type="checkbox"/> 5 <input type="checkbox"/> 6 <input type="checkbox"/> 7 <input type="checkbox"/> 8 <input type="checkbox"/> 9 <input type="checkbox"/> 10 <input type="checkbox"/> 11 <input type="checkbox"/> 12 <input type="checkbox"/> 13
IGMP Snooping	<input checked="" type="radio"/> Enable <input type="radio"/> Disable
WMM Capable	<input type="radio"/> Enable <input checked="" type="radio"/> Disable
MAC Clone	<input type="radio"/> Enable <input checked="" type="radio"/> Disable <input type="text"/>
<b>MAC Clone:</b>	Set the MAC address of SSIDs and the Wireless client. Please notice that the last byte of this MAC address must be a multiple of 8.

Available settings are explained as follows:

Item	Description
<b>Channel Bandwidth</b>	<p><b>20 MHz-</b> the device will use 20MHz for data transmission and receiving between the AP and the stations.</p> <p><b>Auto 20/40 MHz-</b> the AP will scan for nearby wireless AP, and then use 20MHz if the number of AP is more than 10, or use 40MHz if it's not.</p> <p><b>40 MHz-</b> the device will use 40MHz for data transmission and receiving between the AP and the stations.</p>
<b>Packet-OVERDRIVE</b>	<p>This feature can enhance the performance in data transmission about 40%* more (by checking <b>Tx Burst</b>). It is active only when both sides of Access Point and Station (in wireless client) invoke this function at the same time. That is, the wireless client must support this feature and invoke the function, too.</p> <p><b>Note:</b> Vigor N61 wireless adapter supports this function.</p>

Therefore, you can use and install it into your PC for matching with Packet-OVERDRIVE (refer to the following picture of Vigor N61 wireless utility window, choose **Enable** for **TxBURST** on the tab of **Option**).

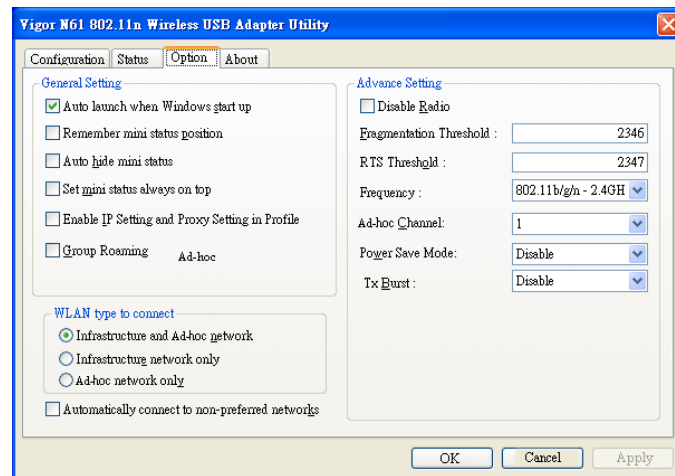

<b>Antenna</b>	VigorAP can be attached with two antennas to have good data transmission via wireless connection. However, if you have only one antenna attached, please choose 1T1R.
<b>Tx Power</b>	The default setting is the maximum (100%). Lowering down the value may degrade range and throughput of wireless.
<b>Rate Adaptation Algorithm</b>	Wireless transmission rate is adapted dynamically. Usually, performance of “new” algorithm is better than “old”.
<b>Fragment Length</b>	Set the Fragment threshold of wireless radio. Do not modify default value if you don’t know what it is, default value is 2346.
<b>RTS Threshold</b>	Minimize the collision (unit is bytes) between hidden stations to improve wireless performance. Set the RTS threshold of wireless radio. Do not modify default value if you don’t know what it is, default value is 2347.
<b>Country Code</b>	VigorAP broadcasts country codes by following the 802.11d standard. However, some wireless stations will detect / scan the country code to prevent conflict occurred. If conflict is detected, wireless station will be warned and is unable to make network connection. Therefore, changing the country code to ensure successful network connection will be necessary for some clients.
<b>Auto Channel Filtered Out List</b>	The selected wireless channels will be discarded if <b>AutoSelect</b> is selected as <b>Channel</b> selection mode in <b>Wireless LAN&gt;&gt;General Setup</b> .
<b>IGMP Snooping</b>	Check <b>Enable</b> to enable IGMP Snooping. Multicast traffic will be forwarded to ports that have members of that group. Disabling IGMP snooping will make multicast traffic treated in the same manner as broadcast traffic.
<b>WMM Capable</b>	To apply WMM parameters for wireless data transmission, please click the <b>Enable</b> radio button.
<b>MAC Clone</b>	Click <b>Enable</b> and manually enter the MAC address of the device with SSID 1. The MAC address of other SSIDs will

change based on this MAC address.

### 3.9.6 AP Discovery

VigorAP 810 can scan all regulatory channels and find working APs in the neighborhood. Based on the scanning result, users will know which channel is clean for usage. Also, it can be used to facilitate finding an AP for a WDS link. Notice that during the scanning process (about 5 seconds), no client is allowed to connect to Vigor.

This page is used to scan the existence of the APs on the wireless LAN. Yet, only the AP which is in the same channel of VigorAP 810 can be found. Please click **Scan** to discover all the connected APs.

Wireless LAN >> Access Point Discovery

#### Access Point List

Enable AP Monitor Mode

Select	Index	SSID	BSSID	RSSI	Channel	Encryption	Authentication	Mode	Ch. Width
<input type="radio"/>	1	staffs_5F_...	00:1d:aa:f8:c9:c8	100%	1	TKIP/AES	Mixed(WPA+WPA2)/PSK	11b/g/n	20
<input type="radio"/>	2	guests_v29...	02:1d:aa:f8:c9:c8	100%	1	TKIP/AES	Mixed(WPA+WPA2)/PSK	11b/g/n	20
<input type="radio"/>	3	staffs_v29...	02:1d:aa:f9:c9:c8	100%	1	TKIP/AES	Mixed(WPA+WPA2)/PSK	11b/g/n	20
<input type="radio"/>	4	GRX350_24G...	00:e0:92:00:01:50	20%	1	AES	WPA2/PSK	11b/g/n	20
<input type="radio"/>	5		00:1d:aa:b6:1b:b8	20%	1	TKIP/AES	Mixed(WPA+WPA2)/PSK	11b/g/n	20
<input type="radio"/>	6	staffs_6F	00:1d:aa:9c:f6:44	70%	6	TKIP/AES	Mixed(WPA+WPA2)/PSK	11b/g/n	20
<input type="radio"/>	7	guests	06:1d:aa:9c:f6:44	81%	6	TKIP/AES	Mixed(WPA+WPA2)/PSK	11b/g/n	20
<input type="radio"/>	8	DrayTek_Ia...	00:1d:aa:00:00:00	29%	11	NONE		11b/g/n	20
<input type="radio"/>	9	Vigor2862-...	00:1d:aa:9e:2b:38	50%	11	TKIP/AES	Mixed(WPA+WPA2)/PSK	11b/g/n	20
<input type="radio"/>	10	DrayTek_V2...	00:1d:aa:f0:26:20	70%	11	TKIP/AES	Mixed(WPA+WPA2)/PSK	11b/g/n	40
<input type="radio"/>	11	DrayTek	00:1d:aa:f7:c0:f0	60%	11	NONE		11b/g/n	20
<input type="radio"/>	12	Vigor2860-...	00:1d:aa:9d:20:0c	15%	11	AES	WPA2/PSK	11b/g/n	20

Scan

See [Channel Interference](#)

**Note:** During the scanning process (about 5 seconds), no station is allowed to connect with the AP.

AP's MAC Address  :  :  :  :  :

AP's SSID

Select as **Universal Repeater**:

Each item is explained as follows:

Item	Description
<b>Enable AP Monitor Mode</b>	This function can help to get and keep the records of APs detected by such device after clicking Scan.  In general, only the available AP will be detected by Vigor device. Once the AP is unavailable, it will be deleted from the Access Point List immediately. However, if such function is enabled, the system will keep the record of the AP (once detected by Vigor device) until it is available for Vigor device again.
<b>SSID</b>	Display the SSID of the AP scanned by VigorAP 810.
<b>BSSID</b>	Display the MAC address of the AP scanned by VigorAP 810.
<b>RSSI</b>	Display the signal strength of the access point. RSSI is the abbreviation of Receive Signal Strength Indication.
<b>Channel</b>	Display the wireless channel used for the AP that is scanned by VigorAP 810.
<b>Encryption</b>	Display the encryption mode for the scanned AP.
<b>Authentication</b>	Display the authentication type that the scanned AP applied.

<b>Mode</b>	Display the wireless connection mode that the scanned AP used.
<b>Ch. Width</b>	Display the channel width that the scanned AP used.
<b>Scan</b>	It is used to discover all the connected AP. The results will be shown on the box above this button
<b>Channel Statistics</b>	It displays the statistics for the channels used by APs.
<b>AP's MAC Address</b>	If you want the found AP applying the WDS settings, please type in the AP's MAC address.
<b>AP's SSID</b>	To specify an AP to be applied with WDS settings, you can specify MAC address or SSID for the AP. Here is the place that you can type the SSID of the AP.
<b>Select as Universal Repeater</b>	In <b>Universal Repeater</b> mode, WAN would work as station mode and the wireless AP can be selected as a universal repeater. Choose one of the wireless APs from the Scan list.

After finishing this web page configuration, please click **OK** to save the settings.

### 3.9.7 Universal Repeater

The access point can act as a wireless repeater; it can be Station and AP at the same time. It can use Station function to connect to a Root AP and use AP function to serve all wireless stations within its coverage.

**Note:** While using **Universal Repeater** mode, the access point will demodulate the received signal. Please check if this signal is noise for the operating network, then have the signal modulated and amplified again. The output power of this mode is the same as that of WDS and normal AP mode.

#### Wireless LAN >> Universal Repeater

##### Universal Repeater Parameters

SSID	<input type="text"/>
MAC Address (Optional)	<input type="text"/>
Channel	2462MHz (Channel 11) ▼
Security Mode	WPA2 Personal ▼
Encryption Type	AES ▼
Pass Phrase	<input type="text"/>

**Note:** If Channel is modified, the Channel setting of AP would also be changed.

##### Universal Repeater IP Configuration

Connection Type	DHCP ▼
Device Name	AP810

Available settings are explained as follows:

Item	Description
<b>Universal Repeater Parameters</b>	
<b>SSID</b>	Set the name of access point that VigorAP 810 wants to connect to.

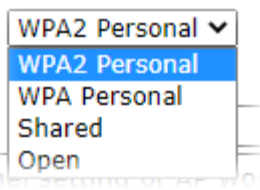
<b>MAC Address (Optional)</b>	Type the MAC address of access point that VigorAP 810 wants to connect to.
<b>Channel</b>	Means the channel of frequency of the wireless LAN. The default channel is 11. You may switch channel if the selected channel is under serious interference. If you have no idea of choosing the frequency, please select <b>AutoSelect</b> to let system determine for you.
<b>Security Mode</b>	<p>There are several modes provided for you to choose. Each mode will bring up different parameters (e.g., WEP keys, Pass Phrase) for you to configure.</p> 
<b>Encryption Type for Open/Shared</b>	<p>This option is available when Open/Shared is selected as Security Mode.</p> <p><b>Encryption Type</b> - Choose <b>None</b> to disable the WEP Encryption. Data sent to the AP will not be encrypted. To enable WEP encryption for data transmission, please choose <b>WEP</b>.</p> <p><b>WEP Keys</b> - Four keys can be entered here, but only one key can be selected at a time. The format of WEP Key is restricted to 5 ASCII characters or 10 hexadecimal values in 64-bit encryption level, or restricted to 13 ASCII characters or 26 hexadecimal values in 128-bit encryption level. The allowed content is the ASCII characters from 33(!) to 126(~) except '#' and ','.</p>
<b>Encryption Type for WPA Personal and WPA2 Personal</b>	<p>This option is available when WPA Personal or WPA2 Personal is selected as <b>Security Mode</b>.</p> <p><b>Encryption Type</b> - Select <b>TKIP</b> or <b>AES</b> as the algorithm for WPA.</p> <p><b>Pass Phrase</b> - Either <b>8~63</b> ASCII characters, such as 012345678 (or 64 Hexadecimal digits leading by 0x, such as "0x321253abcde...").</p>
<b>Universal Repeater IP Configuration</b>	
<b>Connection Type</b>	<p>Choose DHCP or Static IP as the connection mode.</p> <p><b>DHCP</b> – The wireless station will be assigned with an IP from VigorAP.</p> <p><b>Static IP</b> – The wireless station shall specify a static IP for connecting to Internet via VigorAP.</p>
<b>Device Name</b>	<p>This setting is available when <b>DHCP</b> is selected as <b>Connection Type</b>.</p> <p>Type a name for the VigorAP as identification. Simply use the default name.</p>
<b>IP Address</b>	<p>This setting is available when <b>Static IP</b> is selected as <b>Connection Type</b>.</p>



	Type an IP address with the same network segment of the LAN IP setting of VigorAP. Such IP shall be different with any IP address in LAN.
<b>Subnet Mask</b>	This setting is available when <b>Static IP</b> is selected as <b>Connection Type</b> . Type the subnet mask setting which shall be the same as the one configured in LAN for VigorAP.
<b>Default Gateway</b>	This setting is available when <b>Static IP</b> is selected as <b>Connection Type</b> . Type the gateway setting which shall be the same as the default gateway configured in LAN for VigorAP.

After finishing this web page configuration, please click **OK** to save the settings.

### 3.9.8 Bandwidth Management

The downstream or upstream from FTP, HTTP or some P2P applications will occupy large of bandwidth and affect the applications for other programs. Please use Bandwidth Management to make the bandwidth usage more efficient.

Wireless LAN >> Bandwidth Management

SSID 1	SSID 2	SSID 3	SSID 4
SSID		DrayTek-LAN-A	
Per Station Bandwidth Limit			
<b>Enable</b>	<input checked="" type="checkbox"/>		
Upload Limit	User defined	K	bps (Default unit : K)
Download Limit	User defined	K	bps (Default unit : K)
Auto Adjustment	<input checked="" type="checkbox"/>		
Total Upload Limit	User defined	K	bps (Default unit : K)
Total Download Limit	User defined	K	bps (Default unit : K)

**Note:** 1. Download : Traffic going to any station. Upload : Traffic being sent from a wireless station.  
2. Allow auto adjustment could make the best utilization of available bandwidth.

OK Cancel

Available settings are explained as follows:

Item	Description
<b>SSID</b>	Display the specific SSID name of the AP.
<b>Enable</b>	Check this box to enable the bandwidth management for clients.
<b>Upload Limit</b>	Define the maximum speed of the data uploading which will be used for the wireless stations connecting to Vigor AP with the same SSID. Use the drop down list to choose the rate. If you choose <b>User defined</b> , you have to specify the rate manually.
<b>Download Limit</b>	Define the maximum speed of the data downloading which will be used for the wireless station connecting to Vigor AP with the same SSID. Use the drop down list to choose the rate. If you choose <b>User defined</b> , you have to specify the rate manually.

<b>Auto Adjustment</b>	Check this box to have the bandwidth limit determined by the system automatically.
<b>Total Upload Limit</b>	When Auto Adjustment is checked, the value defined here will be treated as the total bandwidth shared by all of the wireless stations with the same SSID for data uploading.
<b>Total Download Limit</b>	When Auto Adjustment is checked, the value defined here will be treated as the total bandwidth shared by all of the wireless stations with the same SSID for data downloading.

After finishing this web page configuration, please click **OK** to save the settings.

### 3.9.9 Airtime Fairness

Airtime fairness is essential in wireless networks that must support critical enterprise applications.

Most of the applications are either symmetric or require more downlink than uplink capacity; telephony and email send the same amount of data in each direction, while video streaming and web surfing involve more traffic sent from access points to clients than the other way around. This is essential for ensuring predictable performance and quality-of-service, as well as allowing 802.11n and legacy clients to coexist on the same network. Without airtime fairness, offices using mixed mode networks risk having legacy clients slow down the entire network or letting the fastest client(s) crowd out other users.

With airtime fairness, every client at a given quality-of-service level has equal access to the network's airtime.

The wireless channel can be accessed by only one wireless station at the same time.

The principle behind the IEEE802.11 channel access mechanisms is that each station has **equal probability** to access the channel. When wireless stations have similar data rate, this principle leads to a fair result. In this case, stations get similar channel access time which is called airtime.

However, when stations have various data rate (e.g., 11g, 11n), the result is not fair. The slow stations (11g) work in their slow data rate and occupy too much airtime, whereas the fast stations (11n) become much slower.

Take the following figure as an example, both Station A(11g) and Station B(11n) transmit data packets through VigorAP 810. Although they have equal probability to access the wireless channel, Station B(11n) gets only a little airtime and waits too much because Station A(11g) spends longer time to send one packet. In other words, Station B(fast rate) is obstructed by Station A(slow rate).

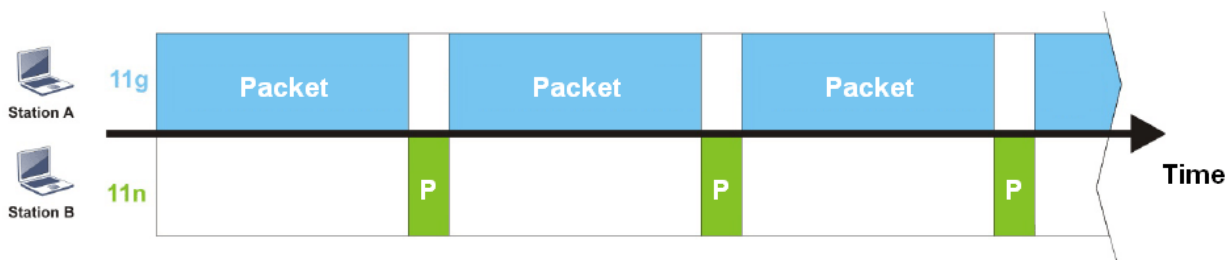

To improve this problem, Airtime Fairness is added for VigorAP 810. Airtime Fairness function tries to assign *similar airtime* to each station (A/B) by controlling TX traffic. In the following figure, Station B(11n) has higher probability to send data packets than Station A(11g). By this way, Station B(fast rate) gets fair airtime and it's speed is not limited by Station A(slow rate).



It is similar to automatic Bandwidth Limit. The dynamic bandwidth limit of each station depends on instant active station number and airtime assignment. Please note that Airtime Fairness of 2.4GHz and 5GHz are independent. But stations of different SSIDs function together, because they all use the same wireless channel. IN SPECIFIC ENVIRONMENTS, this function can reduce the bad influence of slow wireless devices and improve the overall wireless performance.

Suitable environment:

- (1) Many wireless stations.
- (2) All stations mainly use download traffic.
- (3) The performance bottleneck is wireless connection.

**Wireless LAN >> Airtime Fairness**

Enable **Airtime Fairness**  
 Triggering Client Number  (2 ~ 64, Default: 2)

**Note:** Please enable or disable this function according to the real situation and user experience. It is NOT suitable for all environments. You could check **Diagnostics >> Station Airtime** Graph first.

Available settings are explained as follows:

Item	Description
<b>Enable Airtime Fairness</b>	<p>Try to assign similar airtime to each wireless station by controlling TX traffic.</p> <p><b>Airtime Fairness</b> – Click the link to display the following screen of airtime fairness note.</p> <p><b>Triggering Client Number</b> –Airtime Fairness function is applied only when active station number achieves this number.</p>

After finishing this web page configuration, please click **OK** to save the settings.

### 3.9.10 Station Control

Station Control is used to specify the duration for the wireless client to connect and reconnect VigorAP. If such function is not enabled, the wireless client can connect VigorAP until it shuts down.

Such feature is especially useful for free Wi-Fi service. For example, a coffee shop offers free Wi-Fi service for its guests for one hour every day. Then, the connection time can be set as “1 hour” and reconnection time can be set as “1 day”. Thus, the guest can finish his job within one hour and will not occupy the wireless network for a long time.

**Note:** Up to 300 Wireless Station records are supported by VigorAP.

Wireless LAN >> Station Control

SSID 1	SSID 2	SSID 3	SSID 4
SSID		DrayTek-LAN-A	
Enable		<input type="checkbox"/>	
Connection Time		1 hour ▼	
Reconnection Time		1 day ▼	
<a href="#">Display All Station Control List</a>			

**Note:** Once the feature is enabled, the connection time quota will apply to each wireless client (identified by MAC address).

OK      Cancel

Available settings are explained as follows:

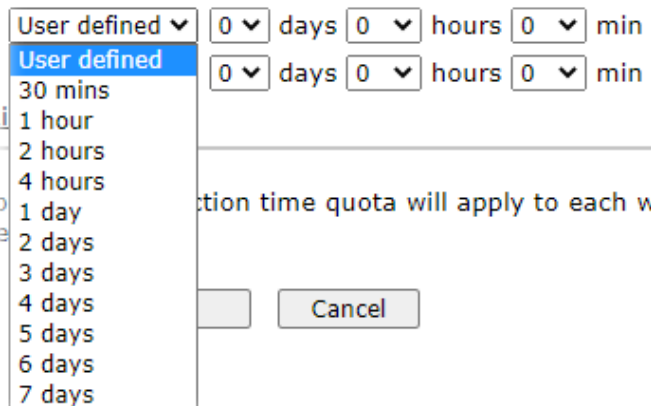
Item	Description
<b>SSID</b>	Display the SSID that the wireless station will use it to connect with Vigor router.
<b>Enable</b>	Check the box to enable the station control function.
<b>Connection Time / Reconnection Time</b>	Use the drop down list to choose the duration for the wireless client connecting /reconnecting to Vigor router. Or, type the duration manually when you choose <b>User defined</b> . 
<b>Display All Station Control List</b>	All the wireless stations connecting to Vigor router by using such SSID will be listed on Station Control List.

After finishing all the settings here, please click **OK** to save the configuration.

### 3.9.11 Roaming

The network signal for a single wireless access point might be limited by its coverage range. Therefore, if you want to expand the wireless network in a large exhibition with a quick method, you can install multiple access points with enabling the Roaming feature for each AP to reach the purpose of expanding wireless signals seamlessly.

These access points connecting for each other shall be verified by pre-authentication. This page allows you to enable the roaming feature and the pre-authentication.

Wireless LAN >> Roaming

#### AP-assisted Client Roaming Parameters

<input type="checkbox"/> <b>Minimum Basic Rate</b>	<input type="text" value="1"/> Mbps
<input checked="" type="radio"/> <b>Disable RSSI Requirement</b>	
<input type="radio"/> <b>Strictly Minimum RSSI</b>	<input type="text" value="-73"/> dBm ( <input type="text" value="42"/> %) (Default: -73)
<input type="radio"/> <b>Minimum RSSI</b>	<input type="text" value="-66"/> dBm ( <input type="text" value="60"/> %) (Default: -66)
with Adjacent AP RSSI over	<input type="text" value="5"/> dB (Default: 5)

#### Fast Roaming(WPA2 Enterprise)

<input type="checkbox"/> <b>Enable</b>	
<b>PMK Caching</b> : Cache Period	<input type="text" value="10"/> minutes (10 ~ 600, Default: 10)
<b>Pre-Authentication</b>	

OK Cancel

Available settings are explained as follows:

Item	Description
<b>AP-assisted Client Roaming Parameters</b>	<p>When the link rate of wireless station is too low or the signal received by the wireless station is too worse, VigorAP 810 will automatically detect (based on the link rate and RSSI requirement) and cut off the network connection for that wireless station to assist it to connect another Wireless AP to get better signal.</p> <p><b>Minimum Basic Rate</b> – Check the box to use the drop down list to specify a basic rate (<b>Mbps</b>). When the link rate of the wireless station is below such value, VigorAP 810 will terminate the network connection for that wireless station.</p> <p><b>Disable RSSI Requirement</b> - If it is selected, VigorAP will not terminate the network connection based on RSSI.</p> <p><b>Strictly Minimum RSSI</b> - VigorAP uses RSSI (received signal strength indicator) to decide to terminate the network connection of wireless station. When the signal strength is below the value (<b>dBm</b>) set here, VigorAP 810 will terminate the network connection for that wireless station.</p> <p><b>Minimum RSSI</b> - When the signal strength of the wireless station is below the value (<b>dBm</b>) set here and adjacent AP (must be DrayTek AP and support such feature too) with higher signal strength value (defined in the field of <b>With Adjacent AP RSSI over</b>) is detected by VigorAP 810, VigorAP 810 will terminate the network connection for that wireless station. Later, the wireless station can connect to the adjacent AP (with better</p>

	<p>RSSI).</p> <ul style="list-style-type: none"> <li>● <b>With Adjacent AP RSSI over</b> – Specify a value as a threshold.</li> </ul>
<p><b>Fast Roaming (WPA/802.1x)</b></p>	<p><b>Enable</b> – Check the box to enable fast roaming configuration.</p> <p><b>PMK Caching: Cache Period</b> - Set the expire time of WPA2 PMK (Pairwise master key) cache. PMK Cache manages the list from the BSSIDs in the associated SSID with which it has pre-authenticated. Such feature is available for <b>WPA2/802.1</b> mode.</p> <p><b>Pre-Authentication</b> - Enables a station to authenticate to multiple APs for roaming securer and faster. With the pre-authentication procedure defined in IEEE 802.11i specification, the pre-four-way-handshake can reduce handoff delay perceivable by a mobile node. It makes roaming faster and more secure. (Only valid in WPA2)</p> <p><b>Enable</b> - Enable IEEE 802.1X Pre-Authentication.</p> <p><b>Disable</b> - Disable IEEE 802.1X Pre-Authentication.</p>

After finishing this web page configuration, please click **OK** to save the settings.

### 3.9.12 Station List

**Station List** provides the knowledge of connecting wireless clients now along with its status code.

Wireless LAN >> Station List

#### Station List

			General	Advanced	Control	Neighbor	
Index	MAC Address	Vendor	RSSI	Approx. Distance	SSID	Visit Time	
1	00:EE:BD:91:B6:74	HTC	20% (-82dBm)	70.79m	N/A	0d:0h: ▲	
2	80:01:84:F7:5B:AB		91% (-54dBm)	2.82m	N/A	0d:0h: █	
3	B8:27:EB:90:4B:A5	Raspberr	52% (-69dBm)	15.85m	N/A	0d:0h:	
4	58:44:98:CB:E1:BD		42% (-73dBm)	25.12m	N/A	0d:0h:	
5	64:09:80:62:E6:7C	Xiaomi	15% (-84dBm)	89.13m	N/A	0d:0h:	
6	BC:EE:7B:A4:90:06	ASUS	20% (-82dBm)	70.79m	N/A	0d:0h:	
7	80:00:0B:04:CE:5A	Intel	68% (-63dBm)	7.94m	N/A	0d:0h:	
8	00:1F:3C:76:96:DE	Intel	52% (-69dBm)	15.85m	N/A	0d:0h: ▼	

**Add to Access Control :**

Client's MAC Address :  :  :  :  :  :

**Note:**

1. Approx. Distance is calculated by actual signal strength of device detected. Inaccuracy might occur based on barrier encountered.
2. Due to the differences in signal strength for different devices, the calculated value of approximate distance also might be different.
3. Trademarks and brand names are the properties of their respective owners.

Available settings are explained as follows:

Item	Description
<b>MAC Address</b>	Display the MAC Address for the connecting client.
<b>SSID</b>	Display the SSID that the wireless client connects to.
<b>Auth</b>	Display the authentication that the wireless client uses for connection with such AP.
<b>Encrypt</b>	Display the encryption mode used by the wireless client.
<b>Tx Rate/Rx Rate</b>	Display the transmission /receiving rate for packets.
<b>Refresh</b>	Click this button to refresh the status of station list.
<b>Add to Access Control</b>	<b>Client's MAC Address</b> - For additional security of wireless access, the Access Control facility allows you to restrict the network access right by controlling the wireless LAN MAC address of client. Only the valid MAC address that has been configured can access the wireless LAN interface.
<b>Add</b>	Click this button to add current typed MAC address into <b>Access Control</b> .

#### General

Display general information (e.g., MAC Address, SSID, Auth, Encrypt, TX/RX Rate) for the station.

#### Advanced



Display more information (e.g., AID, PSM, WMM, RSSI PhMd, BW, MCS, Rate) for the station.

**Control**

Display connection and reconnection time of the wireless stations.

**Neighbor**

Display more information for the neighboring wireless stations.

## 3.10 RADIUS Setting

VigorAP 810 offers a built-in RADIUS server to authenticate the wireless client that tries to connect to VigorAP 810. The AP can accept the wireless connection authentication requested by wireless clients.



### 3.10.1 RADIUS Server

RADIUS Setting >> RADIUS Server Configuration

Enable RADIUS Server

**Authentication Type**

Radius EAP Type PEAP ▼

**Users Profile (up to 96 users)**

Username	Password	Confirm Password	Configure
<input type="text"/>	<input type="text"/>	<input type="text"/>	<input type="button" value="Add"/> <input type="button" value="Cancel"/>
NO.	Username	Select	
<input type="button" value="Delete Selected"/>	<input type="button" value="Delete All"/>		

**Authentication Client (up to 16 clients)**

Client IP	Secret Key	Confirm Secret Key	Configure
<input type="text"/>	<input type="text"/>	<input type="text"/>	<input type="button" value="Add"/> <input type="button" value="Cancel"/>
NO.	Client IP	Select	
<input type="button" value="Delete Selected"/>	<input type="button" value="Delete All"/>		

Backup Radius Cfg :  Upload From File:  未選擇任何檔案

Available settings are explained as follows:

Item	Description
<b>Enable RADIUS Server</b>	Check it to enable the internal RADIUS server.
<b>Authentication Type</b>	Let the user to choose the authentication method for RADIUS server.  <b>Radius EAP Type</b> – There are two types, PEAP and EAP TLS, offered for selection. If EAP TLS is selected, a certificate must be installed or must be ensured to be trusted.

<b>Users Profile</b>	<p><b>Username</b> – Type a new name for the user profile.</p> <p><b>Password</b> – Type a new password for such new user profile.</p> <p><b>Confirm Password</b> – Retype the password to confirm it.</p> <p><b>Configure</b></p> <ul style="list-style-type: none"> <li>● <b>Add</b> – Make a new user profile with the name and password specified on the left boxes.</li> <li>● <b>Cancel</b> – Clear current settings for user profile.</li> </ul> <p><b>Delete Selected</b> – Delete the selected user profile (s).</p> <p><b>Delete All</b> – Delete all of the user profiles.</p>
<b>Authentication Client</b>	<p>This internal RADIUS server of VigorAP 810 can be treated as the external RADIUS server for other users. Specify the client IP and secret key to make the wireless client choosing VigorAP 810 as its external RADUIS server.</p> <p><b>Client IP</b> – Type the IP address for the user to be authenticated by VigorAP 810 when the user tries to use VigorAP 810 as the external RADIUS server.</p> <p><b>Secret Key</b> – Type the password for the user to be authenticated by VigorAP 810 while the user tries to use VigorAP 810 as the external RADIUS server.</p> <p><b>Confirm Secrete Key</b> – Type the password again for confirmation.</p> <p><b>Configure</b></p> <ul style="list-style-type: none"> <li>● <b>Add</b> – Make a new client with IP and secrete key specified on the left boxes.</li> <li>● <b>Cancel</b> – Clear current settings for the client.</li> </ul> <p><b>Delete Selected</b> – Delete the selected client(s).</p> <p><b>Delete All</b> – Delete all of the clients.</p>
<b>Backup</b>	<p>Click it to store the settings (RADIUS configuration) on this page as a file.</p>
<b>Restore</b>	<p>Click it to restore the settings (RADIUS configuration) from an existed file.</p>

After finishing this web page configuration, please click **OK** to save the settings.

### 3.10.2 Certificate Management

When the local client and remote client are required to make certificate authentication (e.g., IPsec X.509) for data passing through SSL tunnel and avoiding the attack of MITM, a trusted root certificate authority (Root CA) will be used to authenticate the digital certificates offered by both ends.

However, the procedure of applying digital certificate from a trusted root certificate authority is complicated and time-consuming. Therefore, Vigor router offers a mechanism which allows you to generate root CA to save time and provide convenience for general user. Later, such root CA generated by DrayTek server can perform the issuing of local certificate.

In addition, you can build a Root CA certificate by clicking **Create Root CA** if required.

RADIUS Setting >> X509 Trusted CA Certificate Configuration

Name	Subject	Status	Modify
Root CA	---	---	Create Root CA

- Note:** 1. Please setup the "System Maintenance >> Time and Date" correctly before you try to generate a RootCA.  
2. The Time Zone MUST be setup correctly.

Note that Root CA can be deleted but not edited. If you want to modify the settings for a Root CA, please delete that one and create another one by clicking Create Root CA. After clicking Create Root CA, the web page will be shown as below.

RADIUS Setting >> Create Root CA

Certificate Name	Root CA
<b>Subject Name</b>	
Country (C)	<input type="text"/>
State (S)	<input type="text"/>
Location (L)	<input type="text"/>
Organization (O)	<input type="text"/>
Organization Unit (OU)	<input type="text"/>
Common Name (CN)	<input type="text"/>
Email (E)	<input type="text"/>
Key Type	RSA ▼
Key Size	1024 Bit ▼
Apply to Web HTTPS	<input type="checkbox"/>

Type in all the information and relational settings. Then click **OK**.

## 3.11 Applications

Below shows the menu items for Applications.

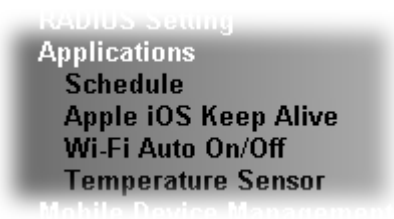

### 3.11.1 Schedule

The Vigor AP has a built-in clock which can update itself manually or automatically by means of Network Time Protocols (NTP). As a result, you can not only schedule the AP to dialup to the Internet at a specified time, but also restrict Internet access to certain hours so that users can connect to the Internet only during certain hours, say, business hours. The schedule is also applicable to other functions.

You have to set your time before set schedule. In **System Maintenance>> Time and Date** menu, press **Inquire Time** button to set the Vigor AP's clock to current time of your PC. The clock will reset once if you power down or reset the AP. There is another way to set up time. You can inquiry an NTP server (a time server) on the Internet to synchronize the AP's clock. This method can only be applied when the WAN connection has been built up.

Schedule : Current System Time 2021 Apr 21 Wed 14:39:04

| System time set | Set to Factory Default |

● Active ● Finished ● Not reached

Index	Enable	Name	Action	Time	Frequency
-------	--------	------	--------	------	-----------

OK

Add

Available settings are explained as follows:

Item	Description
<b>Current System Time</b>	Display current system time.
<b>System time set</b>	Click it to open Time and Date page for configuring the time setting.
<b>Set to Factory Default</b>	Click it to return to the factory default setting and remove all the schedule profiles.
<b>Index</b>	Display the sort number of the schedule profile.
<b>Enable</b>	Check it to enable the function of schedule configuration.
<b>Name</b>	Display the name of the schedule.
<b>Action</b>	Display the action adopted by the schedule profile.
<b>Time</b>	Display the time setting of the schedule.
<b>Frequency</b>	Display the frequency of the time schedule.

You can set up to **15** schedules. To add a schedule:

1. Check the box of **Enable Schedule**.
2. Click the **Add** button to open the following web page.

## Add Schedule

<input type="checkbox"/> Enable	
Name	<input type="text"/>
Start Date	2000 ▾ - 1 ▾ - 1 ▾ ( Year - Month - Day )
Start Time	0 ▾ : 0 ▾ ( Hour : Minute )
Duration Time	0 ▾ : 0 ▾ ( Hour : Minute )
End Time	0 ▾ : 0 ▾ ( Hour : Minute )
Action	Auto Reboot ▾
WiFi(2.4GHz)	<input type="checkbox"/> Radio <input type="checkbox"/> SSID2 <input type="checkbox"/> SSID3 <input type="checkbox"/> SSID4
How Often	Once ▾
Weekday	<input type="checkbox"/> Monday <input type="checkbox"/> Tuesday <input type="checkbox"/> Wednesday <input type="checkbox"/> Thursday <input type="checkbox"/> Friday <input type="checkbox"/> Saturday <input checked="" type="checkbox"/> Sunday

**Note:** 1. If we set WiFi schedule "Start Time" and "End Time" at exact same time, AP will execute the schedule without an end time.

2. "Internet Pause" will add Mac into ACL, so please make sure ACL isn't full before applying schedule. If ACL policy is "Disable", AP will change it to "Blocked".

OK

Cancel

Available settings are explained as follows:

Item	Description
------	-------------

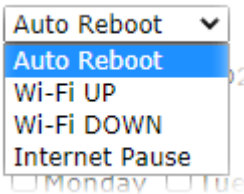
Item	Description
<b>Enable</b>	Check to enable such schedule profile.
<b>Name</b>	Enter the name of the schedule profile.
<b>Start Date</b>	Specify the starting date of the schedule.
<b>Start Time</b>	Specify the starting time of the schedule.
<b>Duration Time</b>	Specify the duration (or period) for the schedule. It is available only for the action set with WIFI UP, WIFI Down, or Internet Pause.
<b>End Time</b>	Specify the ending time of the schedule.
<b>Action</b>	Specify which action should apply the schedule.  In which, you have to specify the device object/device group profile for blocking certain wireless clients when <b>Internet Pause</b> is selected as the Action.
<b>WiFi (2.4GHz)</b>	When <b>Wi-Fi UP</b> or <b>Wi-Fi DOWN</b> is selected as <b>Action</b> , you can check the Radio or SSID 2~4 boxes to setup the network based on the schedule profile. <b>Note:</b> When Radio is selected, SSID2, SSID3 and SSID4 are not available for choosing, vice versa. Moreover, SSID2, SSID3, and SSID4 are not available for choosing if they are not enabled.
<b>How Often</b>	Specify how often the schedule will be applied. <b>Once</b> -The schedule will be applied just once <b>Weekdays</b> -Specify which days in one week should perform the schedule.
<b>Weekday</b>	Choose and check the day to perform the schedule. It is available when <b>Weekdays</b> is selected as <b>How Often</b> .

- After finishing this web page configuration, please click **OK** to save the settings. A new schedule profile has been created and displayed on the screen.

Applications >> Schedule

Schedule : Current System Time 2021 Apr 21 Wed 14:42:28

| System time set | Set to Factory Default |

Index	Enable	Name	Action	Time	Frequency
1	<input checked="" type="checkbox"/>	Formkt	Auto Reboot		Once   

OK

Add

### 3.11.2 Apple iOS Keep Alive

To keep the wireless connection (via Wi-Fi) on iOS device in alive, VigorAP 810 will send the UDP packets with 5353 port to the specific IP every five seconds.

Applications >> Apple iOS Keep Alive

Enable Apple iOS Keep Alive  
**Apple iOS Keep Alive:**  
 Apple iOS Keep Alive can keep Wifi connection of iOS device by sending UDP port 5353 packets every 5 seconds.

Index	Apple iOS Keep Alive IP Address	Index	Apple iOS Keep Alive IP Address
<a href="#">1</a>		<a href="#">2</a>	
<a href="#">3</a>		<a href="#">4</a>	
<a href="#">5</a>		<a href="#">6</a>	

Available settings are explained as follows:

Item	Description
<b>Enable Apple iOS Keep Alive</b>	Check to enable the function.
<b>Index</b>	Display the setting link. Click the index link to open the configuration page for setting the IP address.
<b>Apple iOS Keep Alive IP Address</b>	Display the IP address.

### 3.11.3 Wi-Fi Auto On/Off

When VigorAP is able or unable to ping the specified host, the Wi-Fi function will be turned on or off automatically. The purpose of such function is to avoid wireless station roaming to an AP which is unable to access Internet.

Applications >> Wi-Fi Auto On/Off

#### Wi-Fi Auto On/Off

Enable Auto Switch On/Off Wi-Fi

Ping Host

**Auto Switch On/Off Wi-Fi:**  
Turn on/off the Wi-Fi automatically when the AP is able/unable to ping the host.

OK

Available settings are explained as follows:

Item	Description
<b>Enable Auto Switch On/Off Wi-Fi</b>	Check the box to enable such function.
<b>Ping Host</b>	Type an IP address (e.g., 8.8.8.8) or a domain name (e.g., google.com) for testing if the access point is stable or not.

### 3.11.4 Temperature Sensor

A USB Thermometer is now available that complements your installed DrayTek AP installations that will help you monitor the server or data communications room environment and notify you if the server room or data communications room is overheating.



During summer in particular, it is important to ensure that your server or data communications equipment are not overheating due to cooling system failures.

The inclusion of a USB thermometer in compatible VigorAP will continuously monitor the temperature of its environment. When a pre-determined threshold is reached you will be alerted via Syslog.



## Temperature Sensor Settings

Applications >> Temperature Sensor Setting

Temperature Sensor Graph	Temperature Sensor Settings
<p><b>Display Settings</b></p> <p>Temperature Calibration Offset <input type="text" value="0.00"/> °C (-10C ~ +10C)</p> <p>Temperature Unit <input checked="" type="radio"/> Celsius <input type="radio"/> Fahrenheit</p> <p><b>Alarm Settings</b></p> <p><input checked="" type="checkbox"/> Enable Syslog Alarm</p> <p><input type="checkbox"/> Mail Alert</p> <p>Temperature High Alarm <input type="text" value="0.00"/> °C</p> <p>Temperature Low Alarm <input type="text" value="0.00"/> °C</p>	
<input type="button" value="OK"/>	

Available settings are explained as follows:

Item	Description
<b>Display Settings</b>	<p><b>Temperature Calibration Offset</b>- Type a value used for correcting the temperature error.</p> <p><b>Temperature Unit</b> - Choose the display unit of the temperature. There are two types for you to choose.</p>
<b>Alarm Settings</b>	<p><b>Enable Syslog Alarm</b> - The temperature log containing the alarm message will be recorded on Syslog if it is enabled.</p> <p><b>Mail Alert</b> - The system will send an alert mail if the temperature over the limit.</p> <p><b>Temperature High Alarm/ Temperature Low Alarm</b> - Type the upper limit and lower limit for the system to send out temperature alert.</p>

## Temperature Sensor Graph

Below shows an example of temperature graph:

USB Application >> USB Temper Record

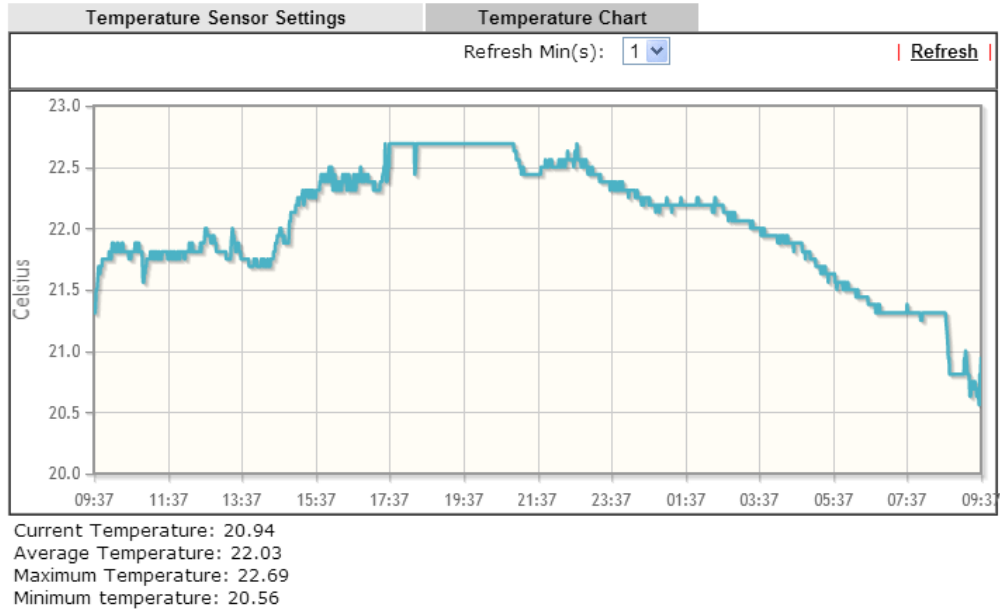

## 3.12 Mobile Device Management

Such feature can control / manage the mobile devices accessing the wireless network of VigorAP. VigorAP offers wireless LAN service for mobile device(s), PC users, MAC users or other users according to the policy selected.

Below shows the menu items for Mobile Device Management.







### 3.12.1 Detection

Such page displays mobile device(s) detected by VigorAP. Detected device(s) with Policy – **Pass** can access into the wireless LAN offered by VigorAP. Detected device(s) with Policy – **Block** are not allowed to access into Internet via VigorAP's WLAN.





Mobile Device Management >> Detection

Enable Mobile Device Management

Refresh Seconds: 10 Page: 1 [Refresh](#)

Index	OS	MAC	Vendor	Model	Policy
1		F0:DB:F8:1C:E4:9F	Apple	iPad	Pass
2		F4:F1:5A:8A:E8:89	Apple	iPhone	Pass
3		60:FA:CD:71:9B:91	Apple	Detecting	Pass
4		44:2A:60:80:15:D6	Apple	Detecting	Pass

Note : Please make sure your internet access is available before enabling MDM.

 iOS  Android  Windows  Linux  Others

Once you check/uncheck the box of **Enable Mobile Device Management** and click **OK**, VigorAP will reboot automatically to activate MDM.

At present, OS (for mobile device) categories supported by VigorAP include:

- Windows
- Linux
- iOS
- Andorid
- WindowsPhone
- BlackBerry
- Symbian.

### 3.12.2 Policies

Such page determines which devices (mobile, PC, MAC or others) allowed to make network connections via VigorAP or blocked by VigorAP.

#### Mobile Device Management >> Policy

Block Mobile Connections (OS:Android,iOS...)

Block PC Connections (OS:Windows,Linux,iMac...)

Block Unknown Connections (OS:Others)

---

WiFi(2.4GHz)       SSID1    SSID2    SSID3    SSID4

Each item is explained as follows:

Item	Description
<b>Block Mobile Connections</b>	All of mobile devices will be blocked and not allowed to access into Internet via VigorAP.
<b>Block PC Connections</b>	All of network connections based on PC, MAC or Linux platform will be blocked and terminated.
<b>Block Unknown Connections</b>	Only the unknown network connections (unable to be recognized by Vigor router) will be blocked and terminated.
<b>WiFi(2.4GHz)</b>	Specify the SSID(s) to apply such policy.

After finished the policy selection, click **OK**. VigorAP will *reboot* to activate the new policy automatically.

### 3.12.3 Statistics

The number of detected devices and the number of device(s) passed/blocked according to the policy specified in **Mobile Device Management>>Policy** can be illustrated as doughnut chart.

Mobile Device Management >> Statistics

---

#### Device OS Statistics



#### Policy Statistics



#### Trademark Notice and Attribution:

- The Android robot is reproduced or modified from work created and shared by Google and used according to the terms described in the [Creative Commons 3.0 Attribution](#) License.
- Android is a trademark of Google Inc..
- Tux logo was created by [Larry Ewing](#) and [The GIMP](#) in 1996.

## 3.13 System Maintenance

For the system setup, there are several items that you have to know the way of configuration: Status, TR-069, Administrator Password, Configuration Backup, Syslog/Mail Alert, Time and Date, Management, Reboot System, and Firmware Upgrade.

Below shows the menu items for System Maintenance.



### 3.13.1 System Status

The **System Status** provides basic network settings of Vigor modem. It includes LAN and WAN interface information. Also, you could get the current running firmware version or firmware related information from this presentation.

#### System Status

```

Model                : VigorAP810
Device Name          : VigorAP810
Firmware Version     : 1.3.4
Build Date/Time      : g961_2f4e742 Thu Sep 9 17:30:01 CST 2021
System Uptime        : 0d 01:29:13
Operation Mode       : Universal Repeater
  
```

System	
Memory Total	: 62320 kB
Memory Left	: 21028 kB
Cached Memory	: 25944 kB / 62320 kB

Wireless	
MAC Address	: 00:1D:AA:0F:2E:68
SSID	: SSID1
Channel	: 11
Driver Version	: 2.7.2.0

LAN-A	
MAC Address	: 00:1D:AA:0F:2E:68
IP Address	: 192.168.1.12
IP Mask	: 255.255.255.0

LAN-B	
MAC Address	: 00:1D:AA:0F:2E:68
IP Address	: 192.168.2.2
IP Mask	: 255.255.255.0

Universal Repeater(2.4G)	
MAC Address	: 02:1D:AA:0D:2E:68
SSID	:
Channel	: 11

**WARNING: Your AP is still set to default password. You should change it via System Maintenance menu.**

Each item is explained as follows:

Item	Description
<b>Model Name</b>	Display the model name of the modem.
<b>Firmware Version</b>	Display the firmware version of the modem.
<b>Build Date/Time</b>	Display the date and time of the current firmware build.
<b>System Uptime</b>	Display the period that such device connects to Internet.
<b>Operation Mode</b>	Display the operation mode that the device used.

<i>System</i>	
<b>Memory total</b>	Display the total memory of your system.
<b>Memory left</b>	Display the remaining memory of your system.
<i>LAN</i>	
<b>MAC Address</b>	Display the MAC address of the LAN Interface.
<b>IP Address</b>	Display the IP address of the LAN interface.
<b>IP Mask</b>	Display the subnet mask address of the LAN interface.
<i>Wireless</i>	
<b>MAC Address</b>	Display the MAC address of the WAN Interface.
<b>SSID</b>	Display the SSID of the device.
<b>Channel</b>	Display the channel that the station used for connecting with such device.

### 3.13.2 TR-069

This device supports TR-069 standard. It is very convenient for an administrator to manage a TR-069 device through an Auto Configuration Server, e.g., VigorACS.

System Maintenance >> TR-069 Settings

#### ACS Settings

URL	<input type="text"/>	Wizard
Username	<input type="text"/>	
Password	<input type="text"/>	
	Test With Inform	Event Code PERIODIC
Last Inform Response Time : <span style="color: red;">●</span>		

#### CPE Settings

Enable	<input type="checkbox"/>
SSL(HTTPS) Mode	<input type="checkbox"/>
On	LAN-A
URL	http://192.168.1.2:8069/cwm/CRN.html
Port	8069
Username	vigor
Password	*****

**Note :** SSL(HTTPS) Mode only works when Vigor ACS SI is 1.1.6 and above version.  
Please set default gateway, no matter choose LAN-A or LAN-B.

#### Periodic Inform Settings

Enable	<input checked="" type="checkbox"/>
Interval Time	900 second(s)

#### STUN Settings

<input type="radio"/> Enable <input checked="" type="radio"/> Disable	
Server Address	<input type="text"/>
Server Port	3478
Minimum Keep Alive Period	60 second(s)
Maximum Keep Alive Period	-1 second(s)

OK Cancel

Available settings are explained as follows:

Item	Description
ACS Settings	<p><b>URL/Username/Password</b> – Such data must be typed according to the ACS (Auto Configuration Server) you want to link. Please refer to Auto Configuration Server user’s manual for detailed information.</p> <p><b>Wizard</b> – Click it to enter the IP address of VigorACS server, port number and the handler.</p> <p><b>Test With Inform</b> – Click it to send a message based on the event code selection to test if such CPE is able to communicate with VigorACS server.</p> <p><b>Event Code</b> – Use the drop down menu to specify an event to perform the test.</p>



	<p><b>Last Inform Response Time</b> – Display the time that VigorACS server made a response while receiving Inform message from CPE last time.</p>
<p><b>CPE Settings</b></p>	<p>Such information is useful for Auto Configuration Server (ACS).  <b>Enable</b>– Check the box to allow the CPE Client to connect with Auto Configuration Server.  <b>SSL(HTTPS) Mode</b> - Check the box to allow the CPE client to connect with ACS through SSL.  <b>On</b> – Choose the interface (LAN-A or LAN-B) for VigorAP 810 connecting to ACS server.  <b>Port</b> – Sometimes, port conflict might be occurred. To solve such problem, you might change port number for CPE.  <b>Username/Password</b> – Type the username and password that VigorACS can use to access into such CPE.  <b>DNS Server IP Address</b> – Such field is to specify the IP address if a URL is configured with a domain name.</p> <ul style="list-style-type: none"> <li>● <b>Primary IP Address</b> –You must specify a DNS server IP address here because your ISP should provide you with usually more than one DNS Server. If your ISP does not provide it, the modem will automatically apply default DNS Server IP address: 194.109.6.66 to this field.</li> <li>● <b>Secondary IP Address</b> –You can specify secondary DNS server IP address here because your ISP often provides you more than one DNS Server. If your ISP does not provide it, the modem will automatically apply default secondary DNS Server IP address: 194.98.0.1 to this field.</li> </ul>
<p><b>Periodic Inform Settings</b></p>	<p>The default setting is <b>Enable</b>. Please set interval time or schedule time for the AP to send notification to VigorACS server. Or click <b>Disable</b> to close the mechanism of notification.  <b>Interval Time</b> – Type the value for the interval time setting. The unit is “second”.</p>
<p><b>STUN Settings</b></p>	<p>The default is <b>Disable</b>. If you click <b>Enable</b>, please type the relational settings listed below:  <b>Server Address</b> – Type the IP address of the STUN server.  <b>Server Port</b> – Type the port number of the STUN server.  <b>Minimum Keep Alive Period</b> – If STUN is enabled, the CPE must send binding request to the server for the purpose of maintaining the binding in the Gateway. Please type a number as the minimum period. The default setting is “60 seconds”.  <b>Maximum Keep Alive Period</b> – If STUN is enabled, the CPE must send binding request to the server for the purpose of maintaining the binding in the Gateway. Please type a number as the maximum period. A value of “-1” indicates that no maximum period is specified.</p>

After finishing this web page configuration, please click **OK** to save the settings.

### 3.13.3 Administrator Password

This page allows you to set new password for accessing into web user interface of VigorAP.

System Maintenance >> Administration Password

#### Administrator Settings

Account	<input type="text" value="admin"/>
Old Password	<input type="password" value="....."/>
New Password	<input type="password" value="....."/>
Confirm Password	<input type="password" value="....."/>
Password Strength:	<input type="button" value="Weak"/> <input checked="" type="button" value="Medium"/> <input type="button" value="Strong"/>
Strong password requirements: 1. Have at least one upper-case letter and one lower-case letter. 2. Including non-alphanumeric characters is a plus.	

**Note :** Authorization Account can contain only a-z A-Z 0-9 , ~ ` ! @ \$ % ^ \* ( ) \_ - + = { } [ ] | ; < > . ?  
 Authorization Password can contain only a-z A-Z 0-9 , ~ ` ! @ # \$ % ^ & \* ( ) \_ - + = { } [ ] | \ ; < > . ? /

Available settings are explained as follows:

Item	Description
<b>Account</b>	Type the name for accessing into Web User Interface.
<b>Password</b>	Type in new password in this filed.
<b>Confirm Password</b>	Type the new password again for confirmation.
<b>Password Strength</b>	The system will display the password strength (represented with the word of weak, medium or strong) of the password specified above.

When you click **OK**, the login window will appear. Please use the new password to access into the web user interface again.

### 3.13.4 Configuration Backup

#### Backup the Configuration

Follow the steps below to backup your configuration.

1. Go to **System Maintenance >> Configuration Backup**. The following windows will be popped-up, as shown below.

System Maintenance >> Configuration Backup

**Configuration Backup / Restoration**

**Restoration**

Select a configuration file.

未選擇任何檔案

Please enter the password and click Restore to upload the configuration file.

Password (optional):

**Note:** 1. You will need the same password to do configuration restoration.  
2. The configuration file from the supported model list would be adopted.

---

**Backup**

Please specify a password and click Backup to download current configuration as an encrypted file.

Protect with password

Password  (Max. 23 characters allowed)

Confirm Password

**Note:** Password can contain only a-z A-Z 0-9 , ! @ \$ % ^ \_ - + = { } [ ] . ? /

**Supported Model List**

Model	Note
AP800	All the wireless LAN(5G) functions of AP800 would not be applied to AP810.

2. Click **Backup** button to get into the following dialog. Click **Save** button to open another dialog for saving configuration as a file.

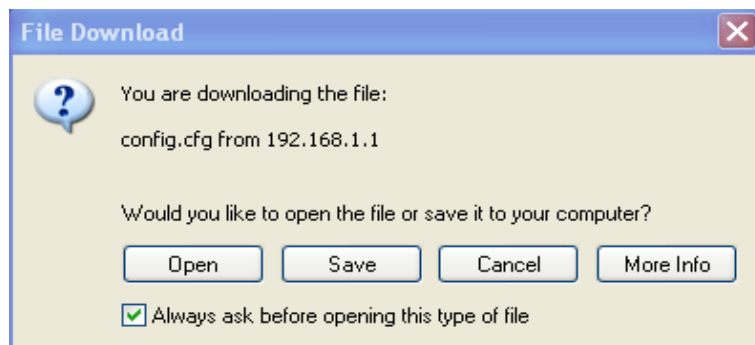

3. In **Save As** dialog, the default filename is **config.cfg**. You could give it another name by yourself.

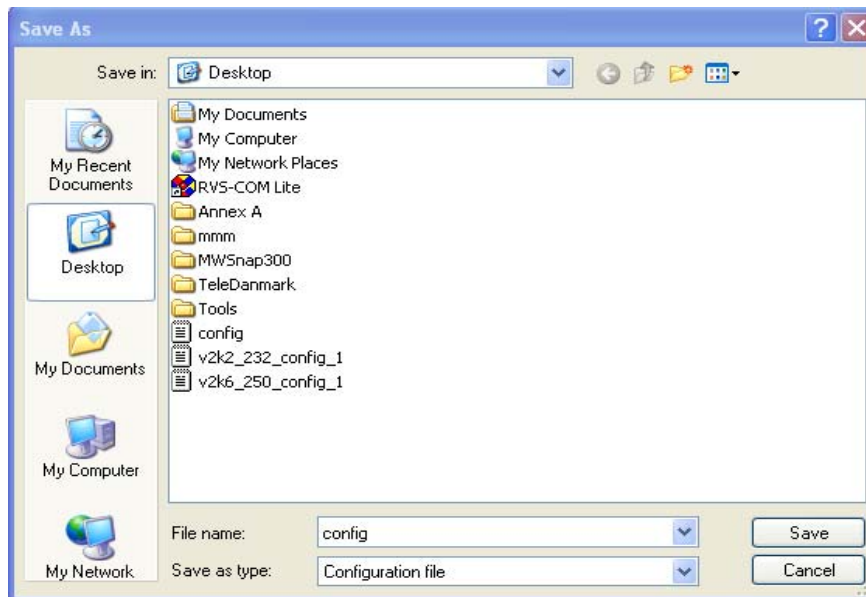

4. Click **Save** button, the configuration will download automatically to your computer as a file named **config.cfg**.

The above example is using **Windows** platform for demonstrating examples. The **Mac** or **Linux** platform will appear different windows, but the backup function is still available.

**Note:** Backup for Certification must be done independently. The Configuration Backup does not include information of Certificate.

## Restore Configuration

1. Go to **System Maintenance >> Configuration Backup**. The following windows will be popped-up, as shown below.

System Maintenance >> Configuration Backup

### Configuration Backup / Restoration

**Restoration**

Select a configuration file.

未選擇任何檔案

Please enter the password and click Restore to upload the configuration file.

Password (optional):

**Note:** 1. You will need the same password to do configuration restoration.  
2. The configuration file from the supported model list would be adopted.

---

**Backup**

Please specify a password and click Backup to download current configuration as an encrypted file.

Protect with password

Password  (Max. 23 characters allowed)

Confirm Password

**Note:** Password can contain only a-z A-Z 0-9 , ! @ \$ % ^ \_ - + = { } [ ] . ? /

### Supported Model List

Model	Note
AP800	All the wireless LAN(5G) functions of AP800 would not be applied to AP810.

2. Click **Browse** button to choose the correct configuration file for uploading to the

modem.

3. Click **Restore** button and wait for few seconds, the system will tell you that the restoration procedure is successful.

### 3.13.5 Syslog/Mail Alert

Syslog function is provided for users to monitor router.

System Maintenance >> Syslog / Mail Alert Setup

#### Syslog Access Setup

Enable	<input type="checkbox"/>
Server IP Address	<input type="text"/>
Destination Port	<input type="text" value="514"/>
Log Level	<input type="text" value="All"/>

#### Mail Alert Setup

Enable	<input type="checkbox"/>
SMTP Server	<input type="text"/>
SMTP Server Port	<input type="text"/>
Mail To	<input type="text"/>
Mail From	<input type="text"/>
User Name	<input type="text"/>
Password	<input type="text"/>
Use TLS	<input checked="" type="checkbox"/>
Enable E-Mail Alert:	
<input checked="" type="checkbox"/> When Admin Login AP	

Available parameters are explained as follows:

Item	Description
<b>SysLog Access Setup</b>	<p><b>Enable</b> - Check <b>Enable</b> to activate function of Syslog.</p> <p><b>Server IP Address</b> -The IP address of the Syslog server.</p> <p><b>Destination Port</b> - Assign a port for the Syslog protocol.</p> <p><b>Log Level</b> – Specify log type on this web page to send the corresponding message of info, warning, error or all.</p>
<b>Mail Alert Setup</b>	<p>Check <b>Enable</b> to activate function of mail alert.</p> <p><b>SMTP Server</b> - The IP address of the SMTP server.</p> <p><b>Mail To</b> - Assign a mail address for sending mails out.</p> <p><b>Mail From</b> - Assign a path for receiving the mail from outside.</p> <p><b>User Name</b> - Type the user name for authentication.</p> <p><b>Password</b> - Type the password for authentication.</p> <p><b>Use TLS</b> – Check this box to encrypt alert mail. However, if the SMTP server specified here does not support TLS protocol, the alert mail with encrypted data will not be received by the receiver.</p>

Item	Description
	<b>Enable E-mail Alert</b> - Check the box to send alert message to the e-mail box while the router detecting the item(s) you specify here.

### 3.13.6 Time and Date

It allows you to specify where the time of the AP should be inquired from.

System Maintenance >> Time and Date

**Time Information**

Current System Time: 2021 Apr 21 Wed 15:03:18

**Time Setting**

Enable NTP Client

Time Zone: (GMT+08:00) China Beijing, Chongqing

NTP Server: pool.ntp.org

Daylight Saving:

NTP synchronization: 1 day

Available parameters are explained as follows:

Item	Description
<b>Current System Time</b>	Click <b>Inquire Time</b> to get the current time.
<b>Use NTP Client</b>	Select to inquire time information from Time Server on the Internet using assigned protocol. This is default setting.
<b>Time Zone</b>	Select a time protocol.
<b>NTP Server</b>	Type the IP address of the time server. <b>Use Default</b> – Click it to choose the default NTP server.
<b>Daylight Saving</b>	Check the box to enable the daylight saving. Such feature is available for certain area.
<b>NTP synchronization</b>	Select a time interval for updating from the NTP server.

Click **OK** to save these settings.

### 3.13.7 SNMP

This page allows you to configure settings for SNMP and SNMPV3 services.

The SNMPv3 is **more secure than** SNMP through the authentication method (support MD5) for the management needs.

System Maintenance >> SNMP

#### SNMP Agent

<input type="checkbox"/>	Enable SNMPv1 / SNMPv2c Agent	
	Get Community	<input type="text" value="public"/>
<input type="checkbox"/>	Enable SNMPv3 Agent	
	USM User	<input type="text"/>
	Auth Algorithm	<input type="text" value="No Auth"/>
	Auth Password	<input type="text"/>

Note: SNMP V1/V2c is read-only and SNMP V3 is read-write.

Available settings are explained as follows:

Item	Description
<b>Enable SNMPv1 / SNMPv2c Agent</b>	Check it to enable this function.
<b>Enable SNMPV3 Agent</b>	Check it to enable this function.
<b>USM User</b>	USM means user-based security mode. Type a username which will be used for authentication. The maximum length of the text is limited to 23 characters.
<b>Auth Algorithm</b>	Choose one of the encryption methods listed below as the authentication algorithm.
<b>Auth Password</b>	Type a password for authentication. The maximum length of the text is limited to 23 characters.

Click **OK** to save these settings.

### 3.13.8 Management

This page allows you to manage the port settings for HTTP and HTTPS.

System Maintenance >> Management

Device Name

---

**Access Control**

Allow management from WLAN

Enable Telnet Server

manage disable reset btn

**Port Setup**

HTTP Port  ( Default:80 )

HTTPS Port  ( Default:443 )

---

**Access List**

Enable access list

List	IP	Mask
1.	<input type="text"/>	<input type="text" value="255.255.255.255 / 32"/> ▼
2.	<input type="text"/>	<input type="text" value="255.255.255.255 / 32"/> ▼
3.	<input type="text"/>	<input type="text" value="255.255.255.255 / 32"/> ▼
4.	<input type="text"/>	<input type="text" value="255.255.255.255 / 32"/> ▼
5.	<input type="text"/>	<input type="text" value="255.255.255.255 / 32"/> ▼

Available parameters are explained as follows:

Item	Description
<b>Device Name</b>	The default setting is VigorAP 1000C. Change the name if required.
<b>Access Control</b>	<b>Allow management from WLAN</b> - Enable the checkbox to allow system administrators to login from wireless LAN. <b>Enable Telnet Server</b> – The administrator / user can access into the command line interface of VigorAP remotely for configuring settings.
<b>Access List</b>	<b>Enable access list</b> – Check the box to specify that the system administrator can only login from a specific host or network defined in the list. A maximum of five IPs/subnet masks is allowed.
<b>Port Setup</b>	<b>HTTP port/HTTPS port</b> -Specify user-defined port numbers for the HTTP and HTTPS servers.

Click **OK** to save these settings.



### 3.13.9 Reboot System

The Web Configurator may be used to restart your modem. Click **Reboot System** from **System Maintenance** to open the following page.

System Maintenance >> Reboot System

#### Reboot System

Do You want to reboot your AP ?

Using current configuration  
 Using factory default configuration

OK

If you want to reboot the modem using the current configuration, check **Using current configuration** and click **OK**. To reset the modem settings to default values, check **Using factory default configuration** and click **OK**. The modem will take 5 seconds to reboot the system.

**Note:** When the system pops up Reboot System web page after you configure web settings, please click **OK** to reboot your modem for ensuring normal operation and preventing unexpected errors of the modem in the future.

### 3.13.10 Firmware Upgrade

Before upgrading your modem firmware, you need to install the Modem Tools. The **Firmware Upgrade Utility** is included in the tools. The following web page will guide you to upgrade firmware by using an example. Note that this example is running over Windows OS (Operating System).

Download the newest firmware from DrayTek's web site or FTP site. The DrayTek web site is [www.draytek.com](http://www.draytek.com) (or local DrayTek's web site) and FTP site is [ftp.draytek.com](ftp://ftp.draytek.com).

Click **System Maintenance>> Firmware Upgrade** to launch the Firmware Upgrade Utility.

System Maintenance >> Firmware Upgrade

#### Firmware Update

Select a firmware file.

未選擇任何檔案

Click Upgrade to upload the file.

#### Firmware Version Status

[Refresh Latest Firmware](#)

Current Firmware Version	: 1.3.4
The Latest Firmware Version	: 1.3.4

Click **Browse** to locate the newest firmware from your hard disk and click **Upgrade**.

## 3.14 Diagnostics

Diagnostic Tools provide a useful way to **view** or **diagnose** the status of your VigorAP 810.

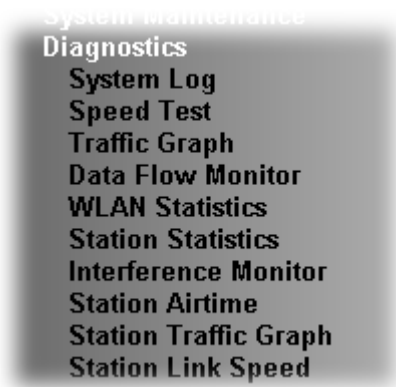

### 3.14.1 System Log

At present, only **System Log** is offered.

Diagnostics >> System Log

System Log Information | [Clear](#) | [Refresh](#) |  Line wrap |

```
Apr 21 15:01:30 syslog: [LPD] Restart lpd server.
Apr 21 15:01:34 syslog: [LPD] Restart lpd server.
Apr 21 15:01:37 syslog: [LPD] Restart lpd server.
Apr 21 15:01:40 syslog: [LPD] Restart lpd server.
Apr 21 15:01:44 syslog: [LPD] Restart lpd server.
Apr 21 15:01:47 syslog: [LPD] Restart lpd server.
Apr 21 15:01:51 syslog: [LPD] Restart lpd server.
Apr 21 15:01:54 syslog: [LPD] Restart lpd server.
Apr 21 15:01:57 syslog: [LPD] Restart lpd server.
Apr 21 15:02:01 syslog: [LPD] Restart lpd server.
Apr 21 15:02:04 syslog: [LPD] Restart lpd server.
Apr 21 15:02:07 syslog: [LPD] Restart lpd server.
Apr 21 15:02:11 syslog: [LPD] Restart lpd server.
Apr 21 15:02:14 syslog: [LPD] Restart lpd server.
Apr 21 15:02:18 syslog: [LPD] Restart lpd server.
Apr 21 15:02:21 syslog: [LPD] Restart lpd server.
Apr 21 15:02:24 syslog: [LPD] Restart lpd server.
```

### 3.14.2 Speed Test

Click the **Start** button on the page to test the speed. Such feature can help you to find the best installation place for Vigor AP.

Diagnostics >> Speed Test

#### Speed Test

Welcome to VigorAP810 Speed Test.

This test allows you to find out the best place for VigorAP810. You can execute the speed test at different places of the building and select the best location for it. The performance test result is only for your reference.

Start

### 3.14.3 Traffic Graph

Click **Traffic Graph** to open the web page. Choose one of the managed Access Points, daily or weekly for viewing data transmission chart. Click **Refresh** to renew the graph at any time.

Diagnostics >> Traffic Graph

Show Chart:

LAN-A

Daily

Refresh

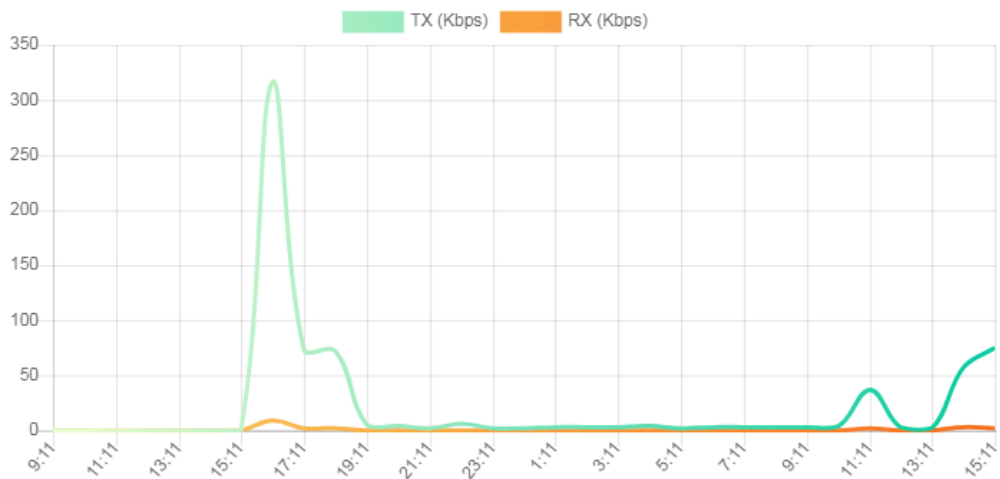

The horizontal axis represents time; the vertical axis represents the transmission rate (in kbps).

### 3.14.4 Data Flow Monitor

This page displays general information for the client connecting to VigorAP 810.

Diagnostics >> Data Flow Monitor

Index	MAC Address	Station	TX rate(Kbps)	RX rate(Kbps)	Action
1					
2					
3					
4					
5					
6					
7					
8					
9					
10					
11					
12					
13					
14					
15					
Total			0	0	

Available parameters are explained as follows:

Item	Description
<b>Auto-refresh</b>	After checking this box, Vigor system will refresh such page periodically.
<b>Refresh</b>	Click this link to refresh this page immediately.
<b>Index</b>	Display the number of the data flow.
<b>MAC Address</b>	Display the MAC address of the monitored device.
<b>Station</b>	Display the IP address/host name of the wireless client.
<b>TX rate (kbps)</b>	Display the transmission speed of the monitored device.
<b>RX rate (kbps)</b>	Display the receiving speed of the monitored device.
<b>Action</b>	<b>DeAuth</b> – Deauthenticate a wireless station.

### 3.14.5 WLAN Statistics

Such page is used for debug by RD only.

Diagnostics >> WLAN Statistics

Auto-Refresh

Tx success	1662	Rx success	148245
Tx retry count	0	Rx with CRC	300131
Tx fail to Rcv ACK after retry	0	Rx drop due to out of resource	0
RTS Success Rcv CTS	0	Rx duplicate frame	0
RTS Fail Rcv CTS	0	False CCA (one second)	1842
TransmitCountFromOS	415	MulticastReceivedFrameCount	0
TransmittedFragmentCount	1662	RealFcsErrCount	300131
TransmittedFrameCount	1662	WEPUndecryptableCount	0
MulticastTransmittedFrameCount	0	MultipleRetryCount	0
TransmittedAMSDUCount	0	ACKFailureCount	0
TransmittedOctetsInAMSDU	0	ReceivedAMSDUCount	0
TransmittedAMPDUCount	0	ReceivedOctetsInAMSDUCount	0
TransmittedMPDUsInAMPDUCount	0	MPDUInReceivedAMPDUCount	0
TransmittedOctetsInAMPDUCount	0	fAnyStaFortyIntolerant	0

	SSID1 (SSID1)	SSID2 (SSID2)	SSID3 (N/A)	SSID4 (N/A)
Packets Received	0	0	N/A	N/A
Packets Sent	0	0	N/A	N/A
Bytes Received	0	0	N/A	N/A
Byte Sent	0	0	N/A	N/A
Error Packets Received	0	0	N/A	N/A
Drop Received Packets	0	0	N/A	N/A

### 3.14.6 Station Statistics

Such page is used for debug or for the user to observe network traffic and network quality.

Diagnostics >> Station Statistics

Show Chart:

[Refresh](#)

Hourly Nearby & Connected Number

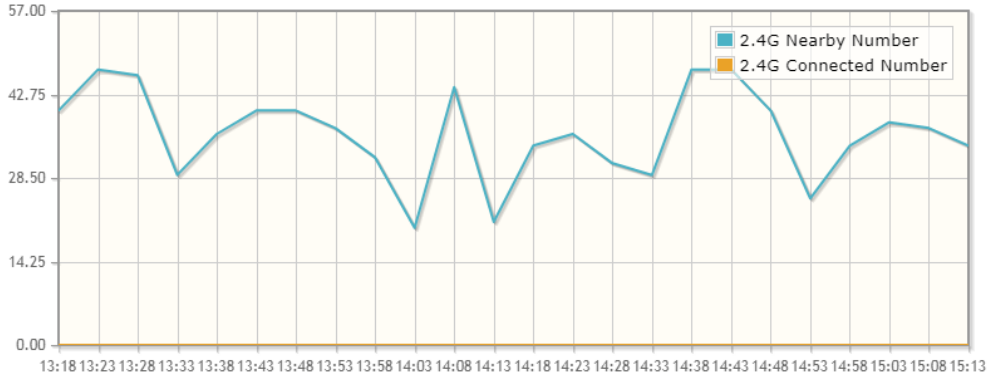

Daily Nearby & Connected Number

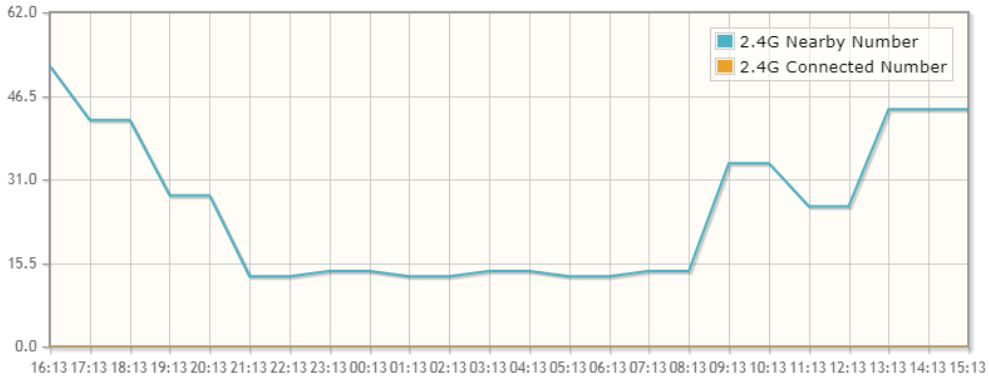

Weekly Nearby & Connected Number

Available parameters are explained as follows:

Item	Description
Show Chart	<p>Choose one of the items to display the statistics chart for wireless stations.</p> <p>Show Chart: <input type="text" value="Nearby &amp; Connected Number"/></p> <p><u>Hourly Nearby</u>. <input type="text" value="Nearby &amp; Connected Number"/></p> <p><input type="text" value="Nearby &amp; Connected Number"/></p> <p><input type="text" value="Visiting &amp; Passing Number"/></p> <p><input type="text" value="Visiting Time"/></p> <p><b>Nearby &amp; Connected Number</b> – Choose it to have the statistics of the wireless stations which is nearby and connected to VigorAP 810.</p> <p><b>Visiting &amp; Passing Number</b> – Choose it to have the statistics of the wireless stations which is visiting and passing to VigorAP 810.</p> <p><b>Visiting Time</b> - Choose it to have the statistics of the wireless stations which is visiting VigorAP 810.</p>

**Daily Connected Number Analysis / Daily Visiting Number Analysis**

Click this button to get analysis pie chart for daily connected wireless stations / daily visiting wireless station.

Daily 2.4G Connected & Not Connected Number Analysis

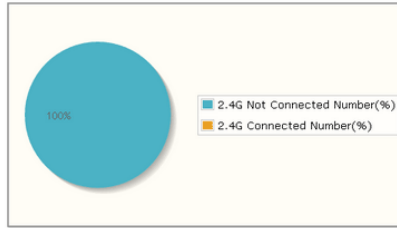

**Peak of Connected Station Number:**  
Time: 14:58-13:58 Number: 0

**Off-peak of Connected Station Number:**  
Time: 14:58-13:58 Number: 0

**Peak of Nearby Station Number:**  
Time: 19:58-20:58 Number: 12

**Off-peak of Nearby Station Number:**  
Time: 14:58-17:58 Number: 0

Daily 5G Connected & Not Connected Number Analysis

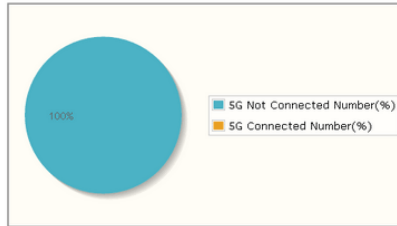

**Peak of Connected Station Number:**  
Time: 14:58-13:58 Number: 0

**Off-peak of Connected Station Number:**  
Time: 14:58-13:58 Number: 0

**Peak of Nearby Station Number:**  
Time: 19:58-20:58 Number: 3  
Time: 13:58 Number: 3

**Off-peak of Nearby Station Number:**  
Time: 14:58-17:58 Number: 0

**Weekly Connected Number Analysis / Weekly Visiting Number Analysis**

Click this button to get analysis pie chart for weekly connected wireless stations / weekly visiting wireless station.

Weekly 2.4G Connected & Not Connected Number Analysis

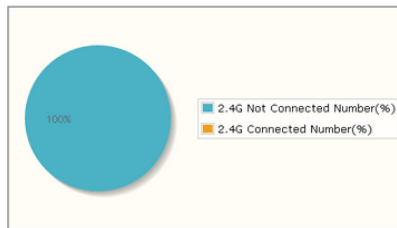

**Peak of Connected Station Number:**  
Time: 2015-8-22(Sun)-2015-9-3(Thu) Number: 0

**Off-peak of Connected Station Number:**  
Time: 2015-8-22(Sun)-2015-9-3(Thu) Number: 0

**Peak of Nearby Station Number:**  
Time: 2015-9-2(Wed) Number: 4

**Off-peak of Nearby Station Number:**  
Time: 2015-8-22(Sun)-2015-9-2(Wed) Number: 0  
Time: 2015-9-3(Thu) Number: 0

Weekly 5G Connected & Not Connected Number Analysis

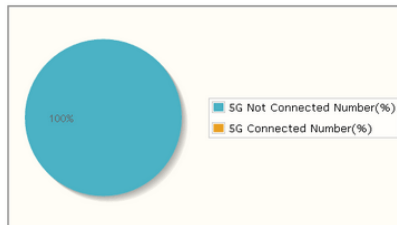

**Peak of Connected Station Number:**  
Time: 2015-8-22(Sun)-2015-9-3(Thu) Number: 0

**Off-peak of Connected Station Number:**  
Time: 2015-8-22(Sun)-2015-9-3(Thu) Number: 0

**Peak of Nearby Station Number:**  
Time: 2015-9-2(Wed) Number: 1

**Off-peak of Nearby Station Number:**  
Time: 2015-8-22(Sun)-2015-9-2(Wed) Number: 0  
Time: 2015-9-3(Thu) Number: 0

### 3.14.7 Interference Monitor

As an interference detector, VigorAP can detect all of the environmental interference factors for certain channel used or for all of the wireless channels.

#### Current Channel

The analysis page with information about wireless band, channel, transmission power, bandwidth, wireless mode, and country code chosen will be displayed on this page. Also, channel status can be seen easily from this page.

Diagnostics >> Interference Monitor

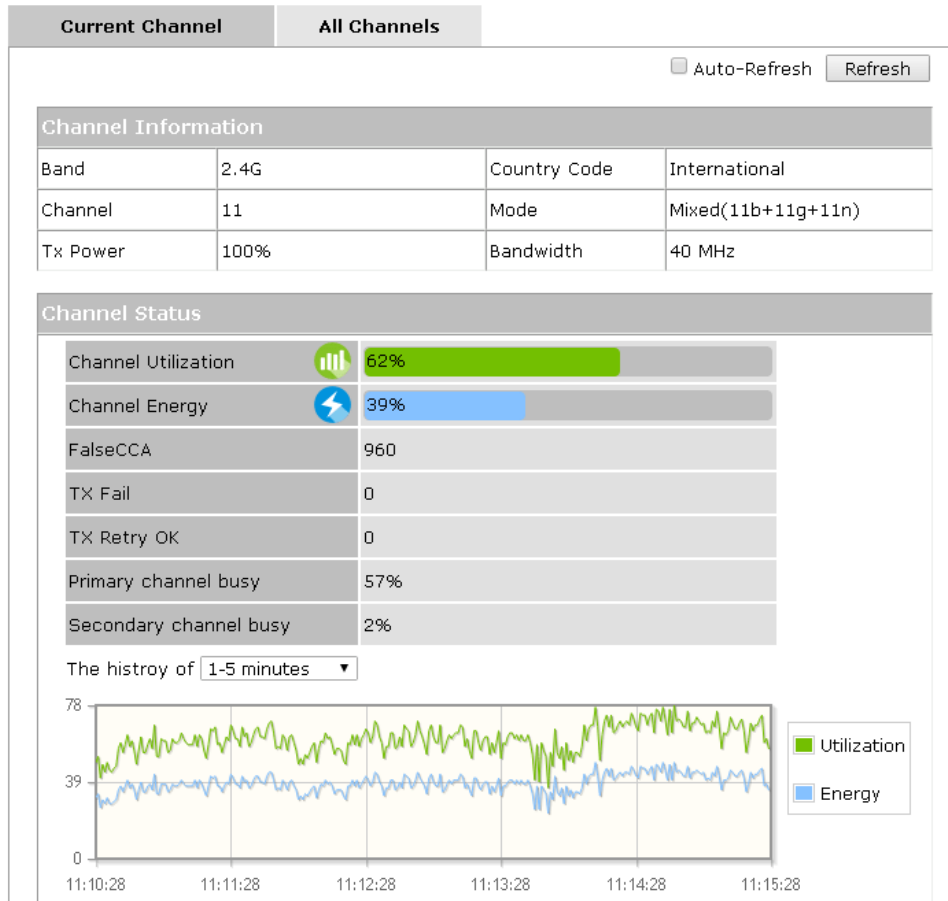



## All Channels

This page displays the utilization and energy result for all channels. Click **Refresh** to get the newly update interference situation.

Diagnostics >> Interference Monitor

**Current Channel** | **All Channels**

Band : 2.4G Refresh

Recommended channel for usage: 8

Channel	Channel Utilization	Channel Energy	APs
1	86%	55%	7
2	45%	33%	0
3	14%	9%	0
4	5%	3%	0
5	5%	3%	0
6	48%	30%	8
7	9%	6%	0
8	11%	7%	3
9	7%	4%	0
10	15%	9%	0
11	63%	40%	9
12	12%	7%	0
13	6%	4%	1

Last updated: 03/17 11:17:50

**Note:** During the scanning process, no station is allowed to connect with the AP.

### 3.14.8 Station Airtime

This page displays the operation status for 2.4GHz wireless stations within 30 minutes.

Diagnostics >> Station Airtime

Display: 2.4GHz  and the history of  Airtime

| [Refresh](#) |

#### 2.4GHz Tx Airtime

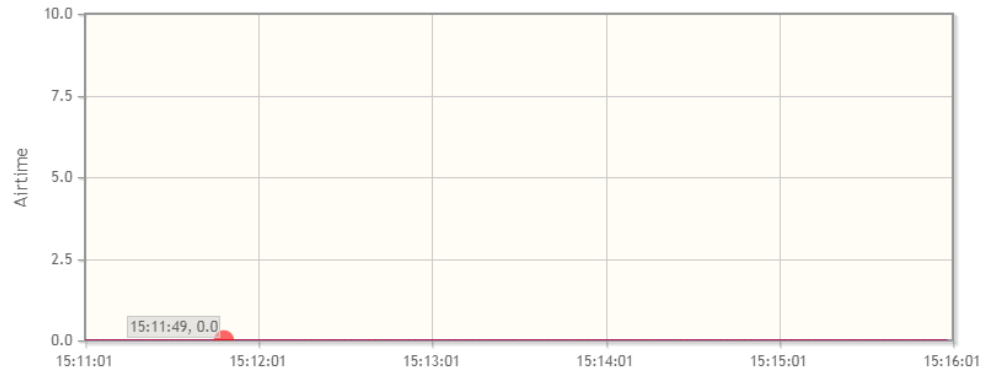

#### 2.4GHz Rx Airtime

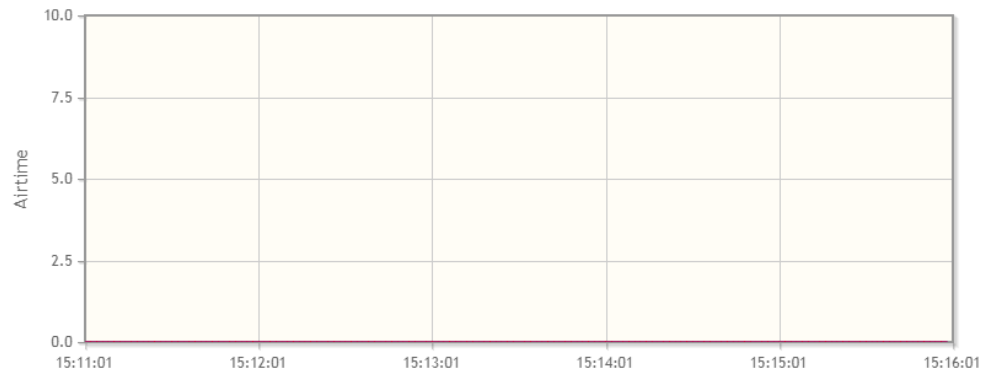

### 3.14.9 Station Traffic Graph

This page displays the data traffic (receiving/transmitting) status for 2.4GHz wireless stations within 30 minutes with a run chart.

Diagnostics >> Station Traffic Graph

Display: 2.4GHz  and the history of  Throughput

[Refresh](#)

2.4GHz Tx Throughput

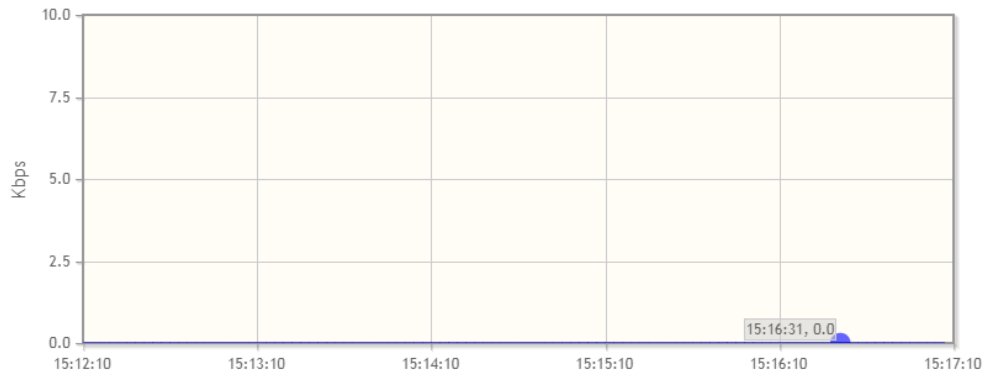

2.4GHz Rx Throughput

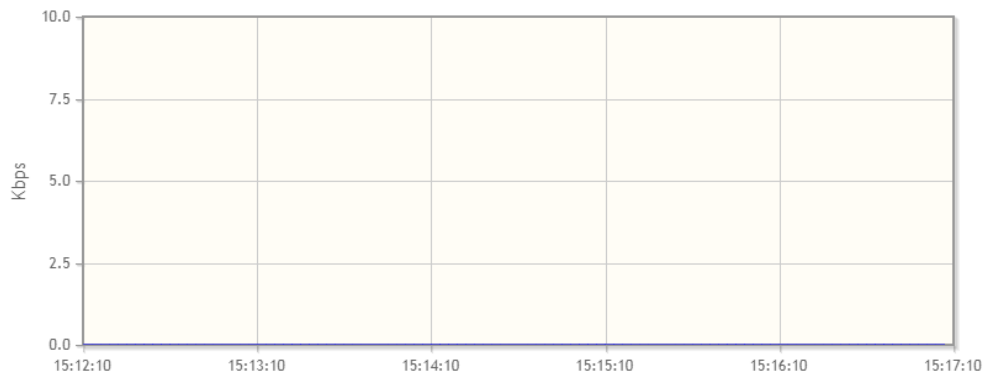

### 3.14.10 Station Link Speed

This page displays the link rate status for 2.4GHz/5GHz wireless stations within one hour with a run chart.

Diagnostics >> Station Link Speed

Display:  Link rate

[Refresh](#)

2.4GHz Link Speed

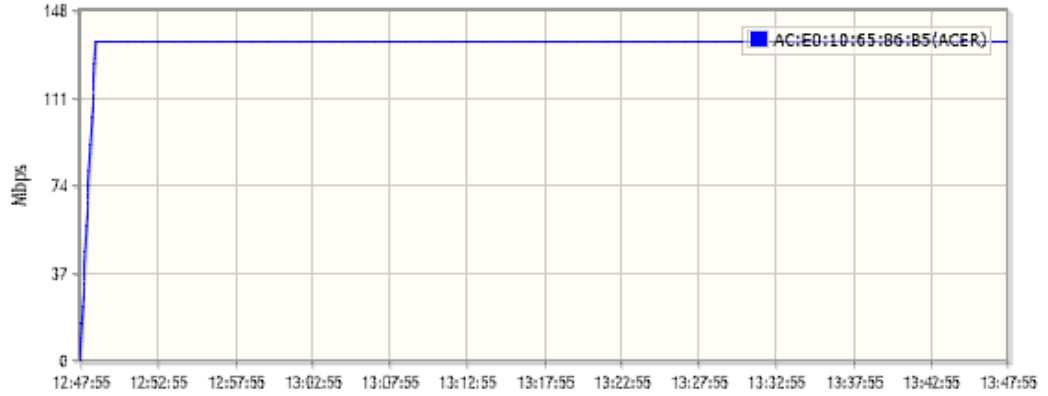

### 3.15 Support Area

When you click the menu item under **Support Area**, you will be guided to visit [www.draytek.com](http://www.draytek.com) and open the corresponding pages directly.

**Support Area**  
Knowledge Base  
Product Registration  
All Rights Reserved.

# 4 Application and Examples

## 4.1 How to set different segments for different SSIDs in VigorAP 810

VigorAP 810 supports two network segments, LAN-A and LAN-B for different SSIDs. With such feature, the user can dispatch SSIDs with different network segments for reaching the target of managing wireless network. See the following figure.

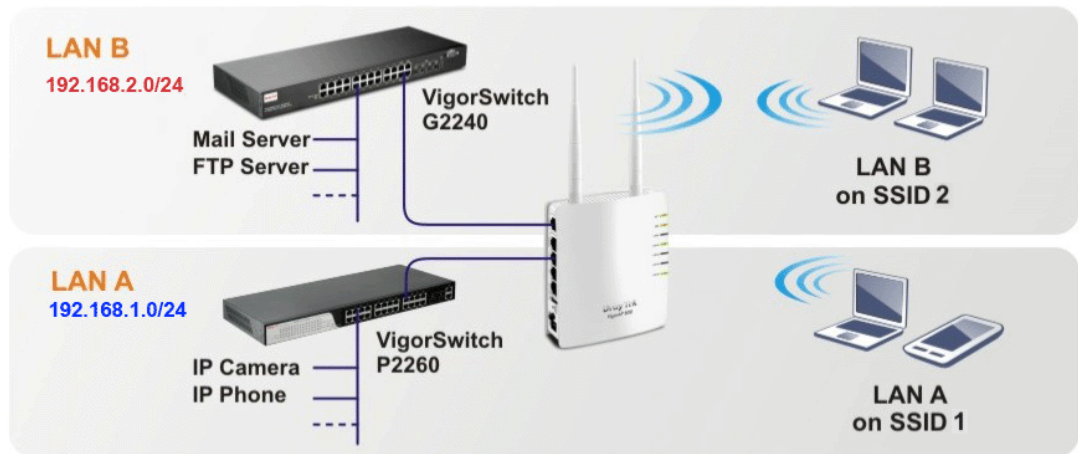

In the above figure, VigorAP 810 is used to control the wireless network connection. It can separate the wireless traffic between accessing internal server and the usage of video. Wireless station connecting to VigorAP 810 with SSID 2 can get the IP address with the network segment of 192.168.1.0/24 (LAN-A); wireless station connecting to VigorAP 810 with SSID 1 can get the IP address with the same network segment of 192.168.2.0/24 (LAN-B).

LAN-B : 192.168.2.0/24 →for internal server

LAN-A : 192.168.1.0/24 →for music, video traffic

Below shows you how to configure the web page for VigorAP 810:

1. In the page of **Operation Mode**, click **AP** mode.

Operation Mode Configuration

---

**Wireless LAN (2.4GHz)**

**AP :**  
VigorAP acts as a bridge between wireless devices and wired Ethernet network, and exchanges data between them.

**Station-Infrastructure :**  
Enable the Ethernet device as a wireless station and join a wireless network through an AP.

**AP Bridge-Point to Point :**  
VigorAP will connect to another VigorAP which uses the same mode, and all wired Ethernet clients of both VigorAPs will be connected together.

**AP Bridge-Point to Multi-Point :**  
VigorAP will connect to up to four VigorAPs which uses the same mode, and all wired Ethernet clients of every VigorAPs will be connected together.

**AP Bridge-WDS :**  
VigorAP will connect to up to four VigorAPs which uses the same mode, and all wired Ethernet clients of every VigorAPs will be connected together.  
This mode is still able to accept wireless clients.

**Universal Repeater :**  
VigorAP can act as a wireless repeater; it can be Station and AP at the same time.

OK

2. Open **Wireless LAN>> General Setup**. Choose the subnet **LAN-B** for SSID 1 and choose **LAN-A** for SSID 2. Specify the wireless channel. Then, click **OK** to save the configuration.

Wireless LAN >> General Setup

---

**General Setting ( IEEE 802.11 )**

Enable Wireless LAN  
 Enable Client Limit  (3 ~ 64, default: 64)  
 Enable Client Limit per SSID (3 ~ 64, default: 64)

---

Mode :   
Channel :   
Extension Channel :

---

Enable 2 Subnet (Simulate 2 APs)

	Enable	Hide SSID	SSID	Subnet	Isolate LAN	Isolate Member	VLAN ID
1	<input type="checkbox"/>	<input type="checkbox"/>	<input type="text" value="SSID1"/>	<input type="text" value="LAN-B"/>	<input type="checkbox"/>	<input type="checkbox"/>	<input type="text" value="0"/>
2	<input checked="" type="checkbox"/>	<input type="checkbox"/>	<input type="text" value="SSID2"/>	<input type="text" value="LAN-A"/>	<input type="checkbox"/>	<input type="checkbox"/>	<input type="text" value="0"/>
3	<input type="checkbox"/>	<input type="checkbox"/>	<input type="text"/>	<input type="text" value="LAN-A"/>	<input type="checkbox"/>	<input type="checkbox"/>	<input type="text" value="0"/>
4	<input type="checkbox"/>	<input type="checkbox"/>	<input type="text"/>	<input type="text" value="LAN-A"/>	<input type="checkbox"/>	<input type="checkbox"/>	<input type="text" value="0"/>

**Hide SSID:** Prevent SSID from being scanned.  
**Isolate LAN:** Wireless clients (stations) with the same SSID cannot access wired PCs on LAN.  
**Isolate Member:** Wireless clients (stations) with the same SSID cannot access for each other.  
**Isolate Exception:** Isolate Exception can be created by adding the MAC from [Device Object](#).

OK      Cancel

- Open **Wireless LAN >> Security Settings**. Set the encryption method and set the password for SSID 1 and SSID 2 respectively.

Wireless LAN >> Security Settings

SSID 1	SSID 2	SSID 3	SSID 4
SSID	SSID1		
Mode	WPA2/WPA Enterprise		
Set up <b>RADIUS Server</b> if 802.1x is enabled.			
<b>WPA</b>			
WPA Algorithms	<input type="radio"/> TKIP <input checked="" type="radio"/> AES <input type="radio"/> TKIP/AES		
Pass Phrase	<input type="password" value="....."/>		
Key Renewal Interval	3600	seconds	
EAPOL Key Retry	<input checked="" type="radio"/> Enable <input type="radio"/> Disable		
<b>WEP</b>			
<input type="radio"/> Key 1 :	<input type="text"/>		Hex
<input checked="" type="radio"/> Key 2 :	<input type="text"/>		Hex
<input type="radio"/> Key 3 :	<input type="text"/>		Hex
<input type="radio"/> Key 4 :	<input type="text"/>		Hex

- Open **LAN>General Setup** to configure the settings for enabling DHCP server on LAN-A/LAN-B. If there is a DHCP server configured in the same network segment, skip this step.

LAN >> General Setup

Ethernet TCP / IP and DHCP Setup

<b>LAN-A IP Network Configuration</b>		<b>DHCP Server Configuration</b>	
<input checked="" type="checkbox"/> Enable DHCP Client		<input checked="" type="radio"/> Enable Server <input type="radio"/> Disable Server	
IP Address	192.168.1.2	<input type="radio"/> Relay Agent	
Subnet Mask	255.255.255.0	For DHCP Client	
Default Gateway		Start IP Address	192.168.1.10
<input type="checkbox"/> Enable Management VLAN		End IP Address	192.168.1.100
VLAN ID	0	Subnet Mask	255.255.255.0
		Default Gateway	192.168.1.2
		Lease Time	86400
		Primary DNS Server	168.95.1.1
		Secondary DNS Server	168.95.192.1
<b>LAN-B IP Network Configuration</b>		<b>DHCP Server Configuration</b>	
<input type="checkbox"/> Enable DHCP Client		<input checked="" type="radio"/> Enable Server <input type="radio"/> Disable Server	
IP Address	192.168.2.2	<input type="radio"/> Relay Agent	
Subnet Mask	255.255.255.0	For DHCP Client	
<input type="checkbox"/> Enable Management VLAN		Start IP Address	192.168.2.10
VLAN ID	0	End IP Address	192.168.2.100
		Subnet Mask	255.255.255.0
		Default Gateway	192.168.2.2
		Lease Time	86400
		Primary DNS Server	168.95.1.1
		Secondary DNS Server	168.95.192.1
<b>DNS Server IP Address</b>			
Primary IP Address	<input type="text"/>		
Secondary IP Address	<input type="text"/>		

5. After finishing the above settings, the wireless equipment connecting to VigorAP 810 with SSID 1 can get the IP address assigned by LAN-B 192.168.2.0/24 for accessing the internal server. The wireless equipment connecting to VigorAP 810 with SSID 2 can get the IP address assigned by LAN-A 192.168.1.0/24 for using the video/audio uploading and downloading services.



# 5

## Trouble Shooting

This section will guide you to solve abnormal situations if you cannot access into the Internet after installing the modem and finishing the web configuration. Please follow sections below to check your basic installation status stage by stage.

- Checking if the hardware status is OK or not.
- Checking if the network connection settings on your computer are OK or not.
- Pinging the modem from your computer.
- Checking if the ISP settings are OK or not.
- Backing to factory default setting if necessary.

If all above stages are done and the modem still cannot run normally, it is the time for you to contact your dealer for advanced help.

### 5.1 Checking If the Hardware Status Is OK or Not

Follow the steps below to verify the hardware status.

1. Check the power line and cable connections.  
Refer to “**1.3 Hardware Installation**” for details.
2. Power on the modem. Make sure the **POWER LED**, **ACT LED** and **LAN LED** are bright.
3. If not, it means that there is something wrong with the hardware status. Simply back to “**1.3 Hardware Installation**” to execute the hardware installation again. And then, try again.

## 5.2 Checking If the Network Connection Settings on Your Computer Is OK or Not

Sometimes the link failure occurs due to the wrong network connection settings. After trying the above section, if the link is still failed, please do the steps listed below to make sure the network connection settings is OK.

### For Windows



The example is based on Windows 7 (Professional Edition). As to the examples for other operation systems, please refer to the similar steps or find support notes in [www.draytek.com](http://www.draytek.com).

1. Open **All Programs>>Getting Started>>Control Panel**. Click **Network and Sharing Center**.



2. In the following window, click **Change adapter settings**.

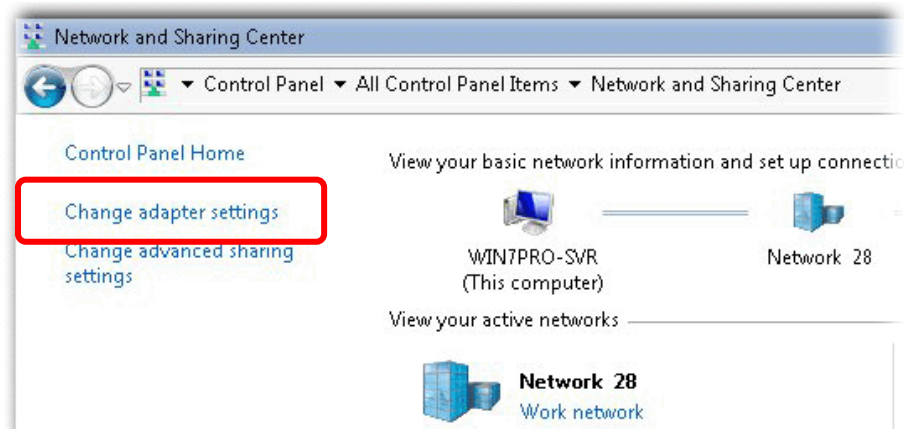

3. Icons of network connection will be shown on the window. Right-click on **Local Area Connection** and click on **Properties**.

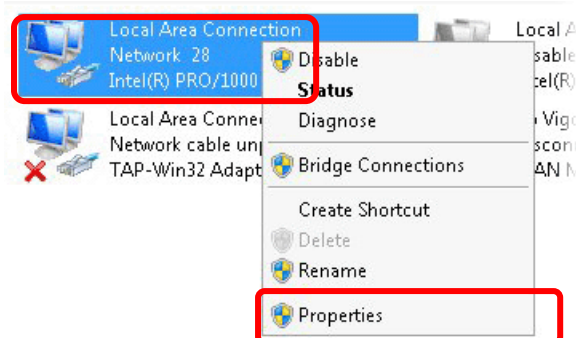

4. Select **Internet Protocol Version 4 (TCP/IP)** and then click **Properties**.

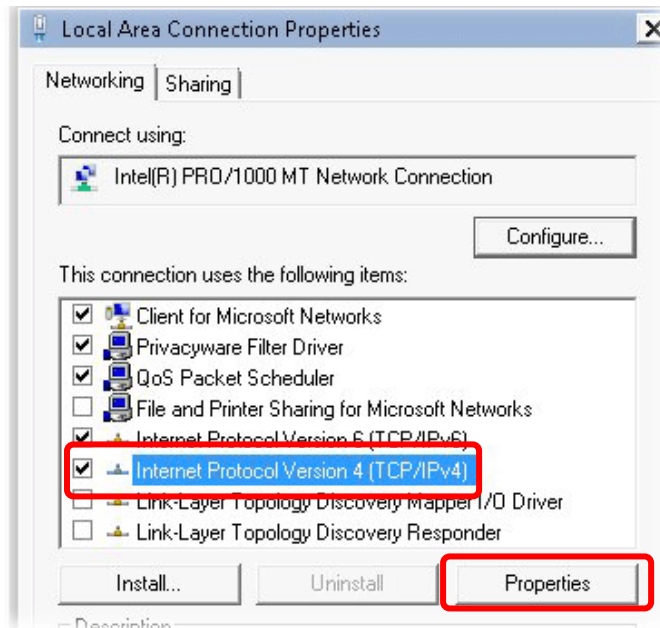

5. Select **Obtain an IP address automatically** and **Obtain DNS server address automatically**. Finally, click **OK**.

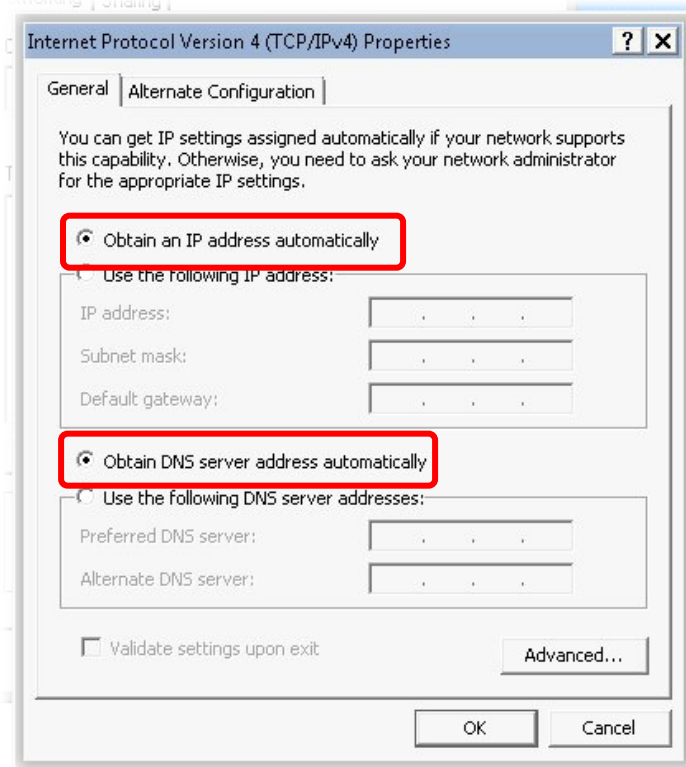

### For Mac Os

1. Double click on the current used Mac Os on the desktop.
2. Open the **Application** folder and get into **Network**.
3. On the **Network** screen, select **Using DHCP** from the drop down list of Configure IPv4.

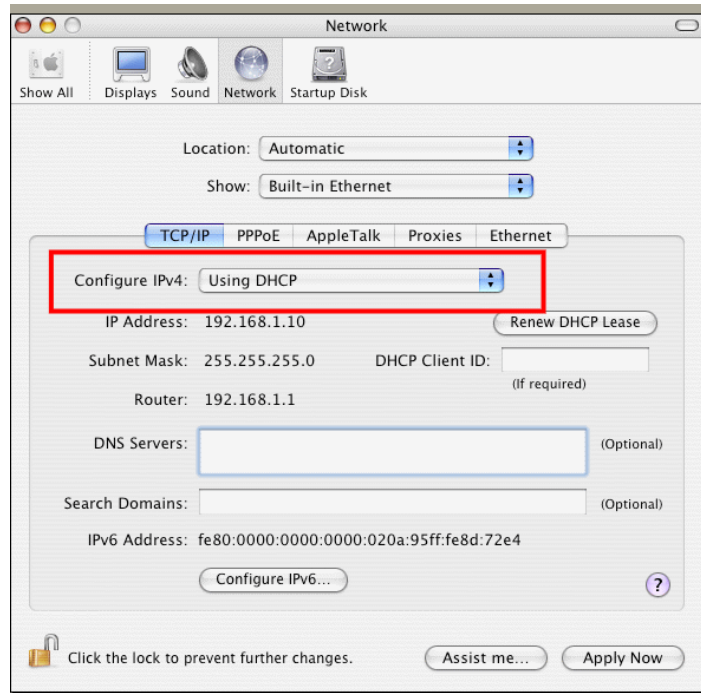

## 5.3 Pinging the Modem from Your Computer

The default gateway IP address of the modem is 192.168.1.2. For some reason, you might need to use “ping” command to check the link status of the modem. **The most important thing is that the computer will receive a reply from 192.168.1.2.** If not, please check the IP address of your computer. We suggest you setting the network connection as **get IP automatically**. (Please refer to the section 5.2)

Please follow the steps below to ping the modem correctly.

### For Windows

1. Open the **Command Prompt** window (from **Start menu**> **Run**).
2. Type **command** (for Windows 95/98/ME) or **cmd** (for Windows NT/ 2000/XP/Vista/7). The DOS command dialog will appear.

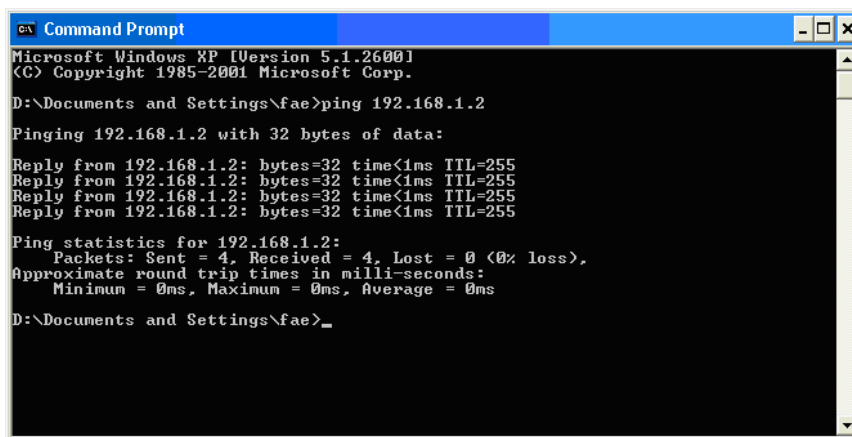

```
ex Command Prompt
Microsoft Windows XP [Version 5.1.2600]
(C) Copyright 1985-2001 Microsoft Corp.

D:\Documents and Settings\fae>ping 192.168.1.2
Pinging 192.168.1.2 with 32 bytes of data:
Reply from 192.168.1.2: bytes=32 time<1ms TTL=255
Reply from 192.168.1.2: bytes=32 time<1ms TTL=255
Reply from 192.168.1.2: bytes=32 time<1ms TTL=255
Reply from 192.168.1.2: bytes=32 time<1ms TTL=255

Ping statistics for 192.168.1.2:
    Packets: Sent = 4, Received = 4, Lost = 0 (0% loss),
    Approximate round trip times in milli-seconds:
        Minimum = 0ms, Maximum = 0ms, Average = 0ms

D:\Documents and Settings\fae>_
```

3. Type ping 192.168.1.2 and press [Enter]. If the link is OK, the line of “**Reply from 192.168.1.2:bytes=32 time<1ms TTL=255**” will appear.
4. If the line does not appear, please check the IP address setting of your computer.

### For Mac Os (Terminal)

1. Double click on the current used Mac Os on the desktop.
2. Open the **Application** folder and get into **Utilities**.
3. Double click **Terminal**. The Terminal window will appear.
4. Type **ping 192.168.1.2** and press [Enter]. If the link is OK, the line of “**64 bytes from 192.168.1.2: icmp\_seq=0 ttl=255 time=xxxx ms**” will appear.

```
Terminal — bash — 80x24
Last login: Sat Jan  3 02:24:18 on ttys1
Welcome to Darwin!
Vigor10:~ draytek$ ping 192.168.1.1
PING 192.168.1.1 (192.168.1.1): 56 data bytes
64 bytes from 192.168.1.1: icmp_seq=0 ttl=255 time=0.755 ms
64 bytes from 192.168.1.1: icmp_seq=1 ttl=255 time=0.697 ms
64 bytes from 192.168.1.1: icmp_seq=2 ttl=255 time=0.716 ms
64 bytes from 192.168.1.1: icmp_seq=3 ttl=255 time=0.731 ms
64 bytes from 192.168.1.1: icmp_seq=4 ttl=255 time=0.72 ms
^C
--- 192.168.1.1 ping statistics ---
5 packets transmitted, 5 packets received, 0% packet loss
round-trip min/avg/max = 0.697/0.723/0.755 ms
Vigor10:~ draytek$
```

## 5.4 Backing to Factory Default Setting If Necessary

Sometimes, a wrong connection can be improved by returning to the default settings. Try to reset the modem by software or hardware.



**Warning:** After pressing **factory default setting**, you will lose all settings you did before. Make sure you have recorded all useful settings before you pressing. The password of factory default is null.

### Software Reset

You can reset the modem to factory default via Web page.

Go to **System Maintenance** and choose **Reboot System** on the web page. The following screen will appear. Choose **Using factory default configuration** and click **OK**. After few seconds, the modem will return all the settings to the factory settings.

System Maintenance >> Reboot System

---

Reboot System

Do You want to reboot your AP ?

Using current configuration  
 Using factory default configuration

OK

### Hardware Reset

While the modem is running, press the **Factory Reset** button and hold for more than 5 seconds. When you see the **ACT** LED blinks rapidly, please release the button. Then, the modem will restart with the default configuration.

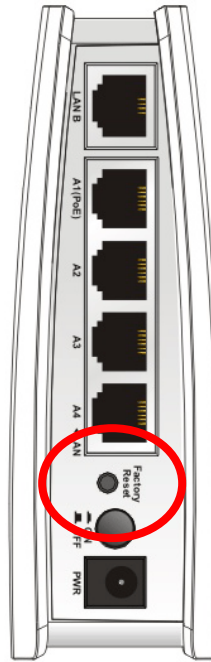

After restore the factory default setting, you can configure the settings for the modem again to fit your personal request.

## 5.5 Contacting DrayTek

If the modem still cannot work correctly after trying many efforts, please contact your dealer for further help right away. For any questions, please feel free to send e-mail to [support@draytek.com](mailto:support@draytek.com).