

DrayTek

Vigor300B

Multi-WAN Load Balancer



Quick Start Guide

V1.01

Vigor300B Multi-WAN Load Balancer Quick Start Guide

Version: 1.01

Firmware Version: V1.0.0_RC3

Date: 15/11/2012

Copyright Information

Copyright Declarations

Copyright 2012 All rights reserved. This publication contains information that is protected by copyright. No part may be reproduced, transmitted, transcribed, stored in a retrieval system, or translated into any language without written permission from the copyright holders.

Trademarks

The following trademarks are used in this document:

- Microsoft is a registered trademark of Microsoft Corp.
- Windows, Windows 95, 98, Me, NT, 2000, XP and Explorer are trademarks of Microsoft Corp.
- Apple and Mac OS are registered trademarks of Apple Computer Inc.
- Other products may be trademarks or registered trademarks of their respective manufacturers.

Safety Instructions and Approval

Safety Instructions

- Read the installation guide thoroughly before you set up the router.
- The router is a complicated electronic unit that may be repaired only by authorized and qualified personnel. Do not try to open or repair the router yourself.
- Do not place the router in a damp or humid place, e.g. a bathroom.
- Do not stack the routers.
- The router should be used in a sheltered area, within a temperature range of +5 to +40 Celsius.
- Do not expose the router to direct sunlight or other heat sources. The housing and electronic components may be damaged by direct sunlight or heat sources.
- Do not deploy the cable for LAN connection outdoor to prevent electronic shock hazards.
- Keep the package out of reach of children.
- When you want to dispose of the router, please follow local regulations on conservation of the environment.

Warranty

We warrant to the original end user (purchaser) that the router will be free from any defects in workmanship or materials for a period of two (2) years from the date of purchase from the dealer. Please keep your purchase receipt in a safe place as it serves as proof of date of purchase. During the warranty period, and upon proof of purchase, should the product have indications of failure due to faulty workmanship and/or materials, we will, at our discretion, repair or replace the defective products or components, without charge for either parts or labor, to whatever extent we deem necessary to restore the product to proper operating condition. Any replacement will consist of a new or re-manufactured functionally equivalent product of equal value, and will be offered solely at our discretion. This warranty will not apply if the product is modified, misused, tampered with, damaged by an act of God, or subjected to abnormal working conditions. The warranty does not cover the bundled or licensed software of other vendors. Defects which do not significantly affect the usability of the product will not be covered by the warranty. We reserve the right to revise the manual and online documentation and to make changes from time to time in the contents hereof without obligation to notify any person of such revision or changes.

Be a Registered Owner

Web registration is preferred. You can register your Vigor router via <http://www.draytek.com>.

Firmware & Tools Updates

Due to the continuous evolution of DrayTek technology, all routers will be regularly upgraded. Please consult the DrayTek web site for more information on newest firmware, tools and documents.

<http://www.draytek.com>

European Community Declarations

Manufacturer: DrayTek Corp.
Address: No. 26, Fu Shing Road, HuKou Township, HsinChu Industrial Park, Hsin-Chu County,
Taiwan 303
Product: Vigor300B Router

DrayTek Corp. declares that Vigor300B of routers are in compliance with the following essential requirements and other relevant provisions of R&TTE Directive 1999/5/EEC.

The product conforms to the requirements of Electro-Magnetic Compatibility (EMC) Directive 2004/108/EEC by complying with the requirements set forth in EN55022/Class A and EN55024/Class A.

The product conforms to the requirements of Low Voltage (LVD) Directive 2006/95/EEC by complying with the requirements set forth in EN60950-1.

Regulatory Information

Federal Communication Commission Interference Statement

This equipment has been tested and found to comply with the limits for a Class A digital device, pursuant to Part 15 of the FCC Rules. These limits are designed to provide reasonable protection against harmful interference in a residential installation. This equipment generates, uses and can radiate radio frequency energy and, if not installed and used in accordance with the instructions, may cause harmful interference to radio communications. However, there is no guarantee that interference will not occur in a particular installation. If this equipment does cause harmful interference to radio or television reception, which can be determined by turning the equipment off and on, the user is encouraged to try to correct the interference by one of the following measures:

- Reorient or relocate the receiving antenna.
- Increase the separation between the equipment and receiver.
- Connect the equipment into an outlet on a circuit different from that to which the receiver is connected.
- Consult the dealer or an experienced radio/TV technician for help.

This device complies with Part 15 of the FCC Rules. Operation is subject to the following two conditions:

- (1) This device may not cause harmful interference, and
- (2) This device may accept any interference received, including interference that may cause undesired operation.

<http://www.draytek.com/user/SupportDLRTTECE.php#>

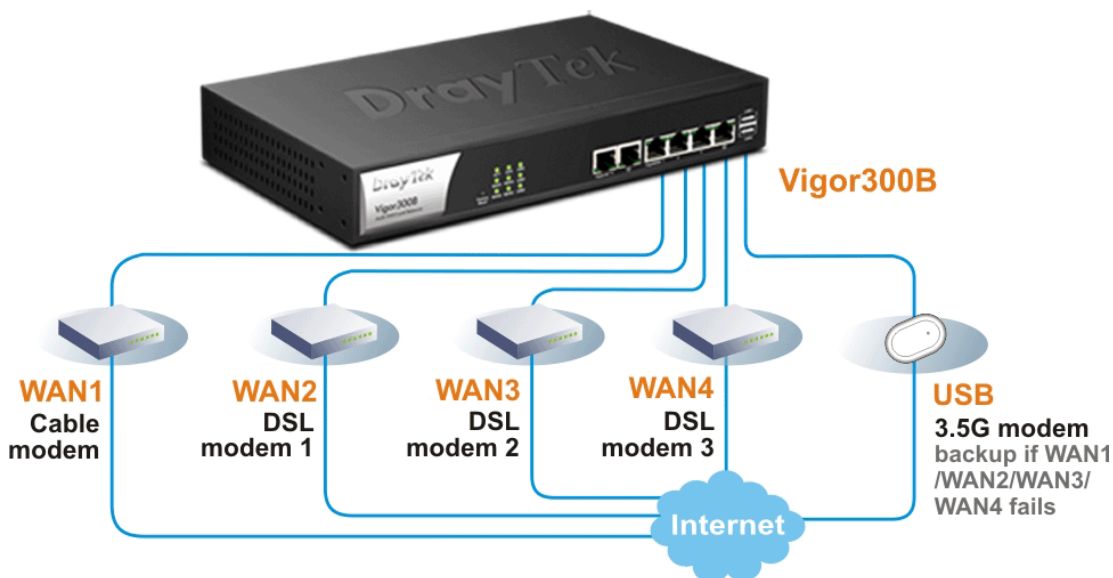

Table of Contents

| | |
|---|-----------|
| 1. Introduction..... | 1 |
| 1.1 Panel Explanation | 3 |
| 1.2 Package Content..... | 5 |
| 2. Installing Your Router..... | 7 |
| 2.1 Hardware Installation..... | 7 |
| 2.2 Rack-Mount and Wall-Mount Installation | 8 |
| 2.3 Printer Installation..... | 10 |
| 3. Configuring Web Pages | 15 |
| 3.1 Accessing Web Page | 15 |
| 3.2 Changing the Password | 16 |
| 3.3 Quick Start Wizard..... | 17 |
| 3.4 Check the Connection Status..... | 24 |
| 4. Trouble Shooting | 25 |
| 4.1 Checking If the Hardware Status Is OK or Not..... | 25 |
| 4.2 Checking If the Network Connection Settings on Your Computer Is OK or Not | 26 |
| 4.3 Pinging the Router from Your Computer | 28 |
| 4.4 Checking If the ISP Settings are OK or Not | 30 |
| 4.5 Backing to Factory Default Setting If Necessary..... | 31 |
| 4.6 Contacting Your Dealer | 32 |

1. Introduction

Vigor300B, a firewall broadband router with multi-WAN interface, can connect to xDSL/cable/VDSL2/Ethernet FTTx. The multi-WAN and LAN switch facilitate unified communication applications in business CO/remote site to handle large data from subscribed fatter pipe. The state-of-art routing feature, and multi-WAN provide integrated benefits for professional users and small offices.



Vigor300B provides policy-based load-balance, fail-over and BOD (Bandwidth on Demand), also it integrates IP layer QoS, NAT session/bandwidth management to help users control works well with large bandwidth.

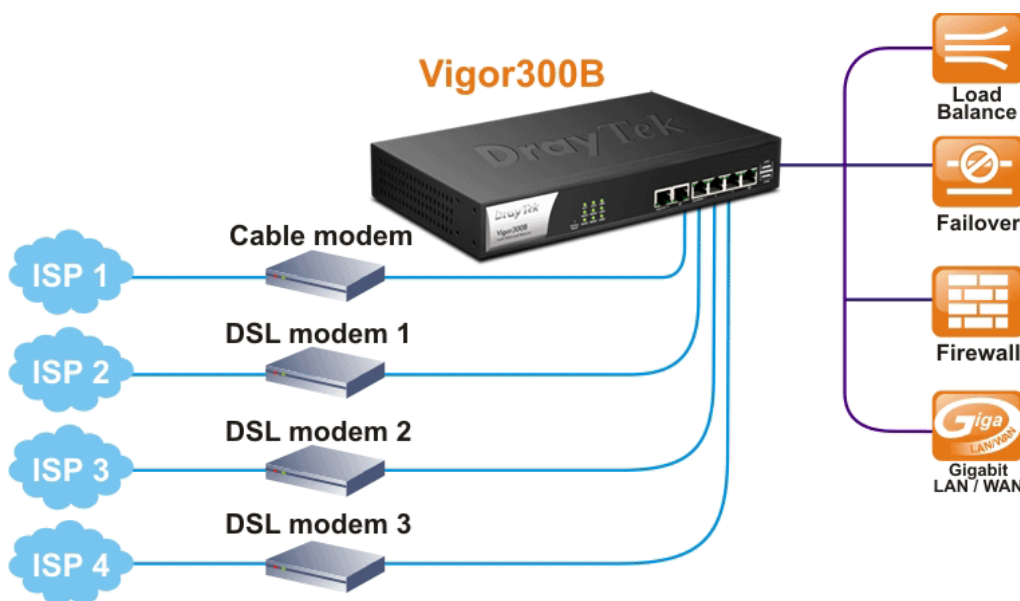

The Object-based design used in SPI (Stateful Packet Inspection) firewall allows users to set firewall policy with ease. CSM (Content Security Management) provides users control and management in IM (Instant Messenger), P2P (Peer to Peer), URL Content Filter and

Web Content Filter more efficiency than before. By the way, DoS/DDoS prevention and URL/Web content filter strengthen the security outside and control inside.

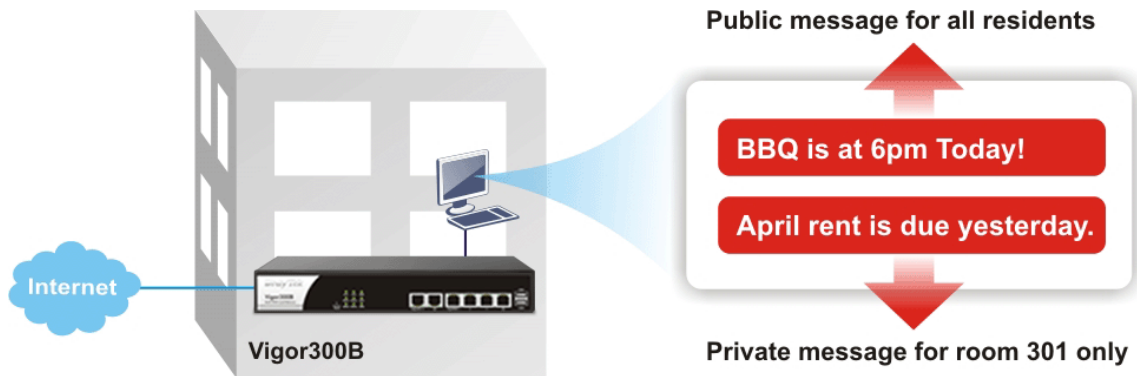

1.1 Panel Explanation

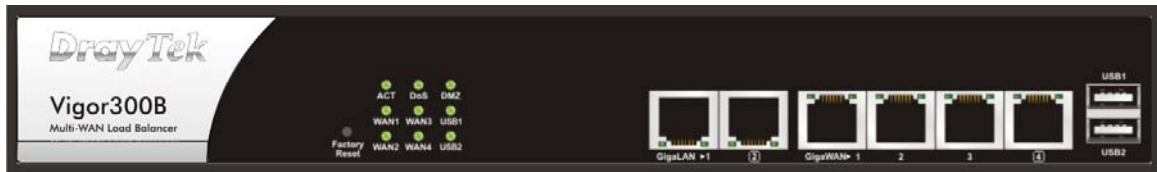

| LED | Status | Explanation |
|----------------|----------|--|
| ACT (Activity) | Blinking | The router is powered on and running normally. |
| | Off | The router is powered off. |
| DoS | On | The DoS/DDoS function is active. |
| | Blinking | It will blink while detecting an attack. |
| DMZ | On | DMZ Host is specified in certain site. |
| | Off | DMZ Host is inactive. |
| WAN1 ~ WAN4 | On | The WAN1 or WAN2 connection is ready. |
| | Blinking | It will blink while transmitting data. |
| USB1 ~ USB2 | On | USB device is connected and ready for use. |
| | Blinking | The data is transmitting. |

LED on Connector

| | | | |
|-----------------------|----------------------|----------|---|
| LAN 1/2 (Giga) | Left LED (Green) | On | The port is connected. |
| | | Off | The port is disconnected. |
| | | Blinking | The data is transmitting. |
| | Right LED (Green) | On | The port is connected with 1000Mbps. |
| | | Off | The port is disconnected with 10/100Mbps. |
| | | Blinking | The data is transmitting. |
| WAN 1/2/3/4 (Giga) | Left LED (Green) | On | The port is connected. |
| | | Off | The port is disconnected. |
| | | Blinking | The data is transmitting. |
| | Right LED (Green) | On | The port is connected with 1000Mbps. |
| | | Off | The port is disconnected with 10/100Mbps. |
| | | Blinking | The data is transmitting. |



| Interface | Description |
|---|---|
| Factory Reset | Restore the default settings. Usage: Turn on the router (ACT LED is blinking). Press the hole and keep for more than 5 seconds. When you see the ACT LED begins to blink rapidly than usual, release the button. Then the router will restart with the factory default configuration. |
| LAN1/2 (Giga) | Connectors for local networked devices. |
| WAN1/2/3/4 (Giga) | Connectors for remote networked devices. |
| USB1/2 | Connector for Mobile HDD, 3G Modem or printer. |
|  | Connector for a power cord. ON/OFF - Power switch. |

1.2 Package Content



1 Quick Start Guide

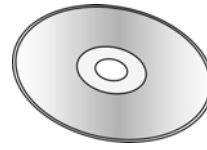

2 CD



3 RJ-45 Cable (Ethernet)

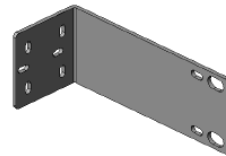

4 Rack mount kit (brackets)

5 The type of the power adapter depends on the country that the router will be installed:



UK-type power cord



EU-type power cord



USA/Taiwan-type power cord



AU/NZ-type power cord

* The maximum power consumption is *20 Watt*.

This page is left blank.

2. Installing Your Router

This section will guide you to install the router through hardware connection and configure the router's settings through web browser.

2.1 Hardware Installation

Before starting to configure the router, you have to connect your devices correctly.

1. Connect one end of an Ethernet cable (RJ-45) to one of the **LAN** ports of Vigor300B.
2. Connect the other end of the cable (RJ-45) to the Ethernet port on your computer (that device also can connect to other computers to form a small area network). The **LAN** LED for that port on the front panel will light up.
3. Connect the cable Modem/DSL Modem/Media Converter to any WAN port of router with Ethernet cable (RJ-45).
4. Connect the power cord to Vigor300B's power port on the rear panel, and the other side into a wall outlet.
5. Power on the device by pressing down the power switch on the rear panel. The **PWR** LED should be **ON**.
6. The system starts to initiate. After completing the system test, the **ACT** LED will light up and start blinking.

(For the detailed information of LED status, please refer to section 1.1.)

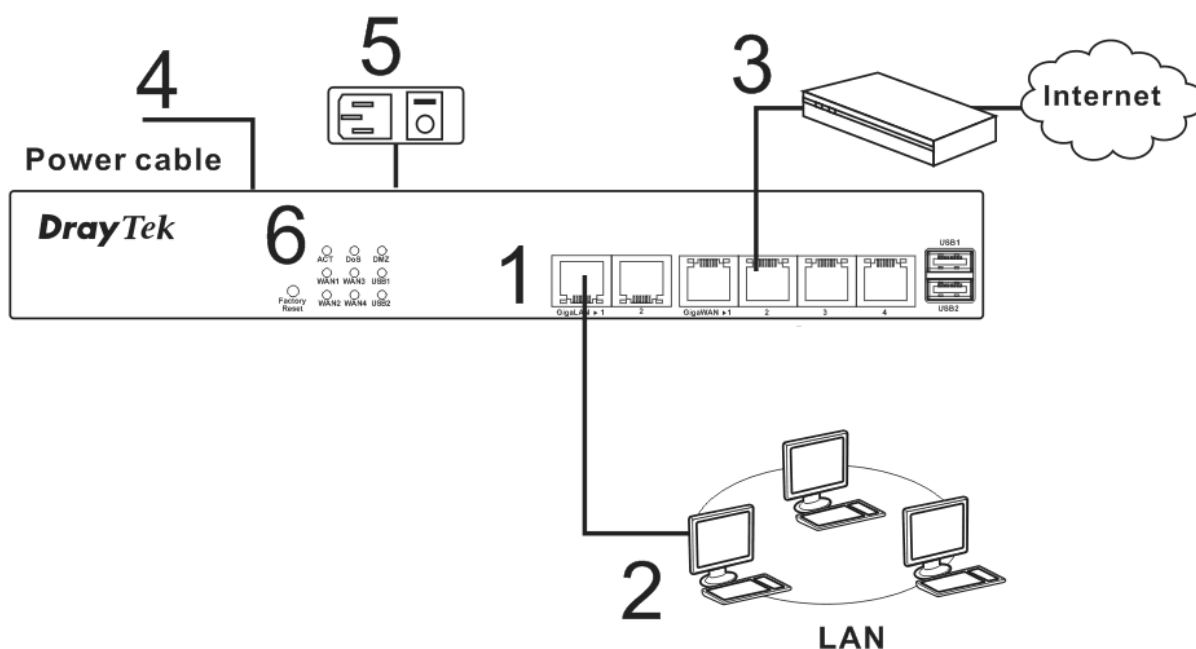

2.2 Rack-Mount and Wall-Mount Installation

The Vigor300B can be mounted on the wall by using standard brackets shown below.

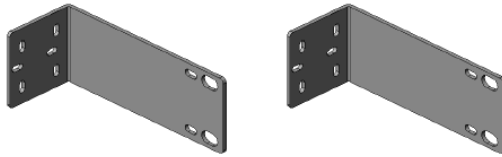

Before mounting the router on the wall or the rack, you have to make sure that power is OFF. Remember to remove the power cable and all network interface cables, and consider the cable limitations and the wall structure when choosing a wall for mounting.

Do the following steps to mount the router on rack:

1. Attach the brackets on each side of the chassis by using the machine screws. Each side requires four screws.

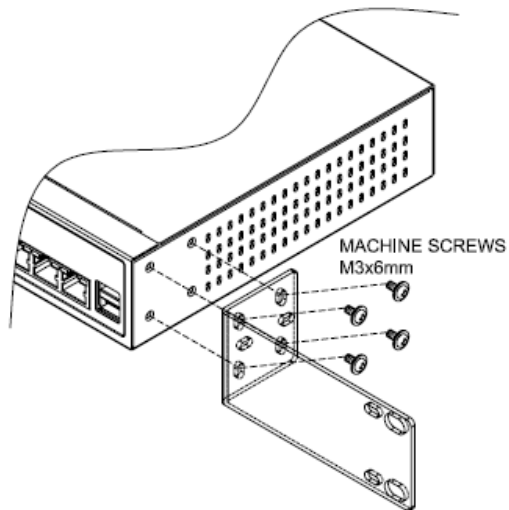

2. Make the holes on the brackets align to the holes on the rack. Use machine screws to fasten the brackets on the rack. Each side requires two screws.

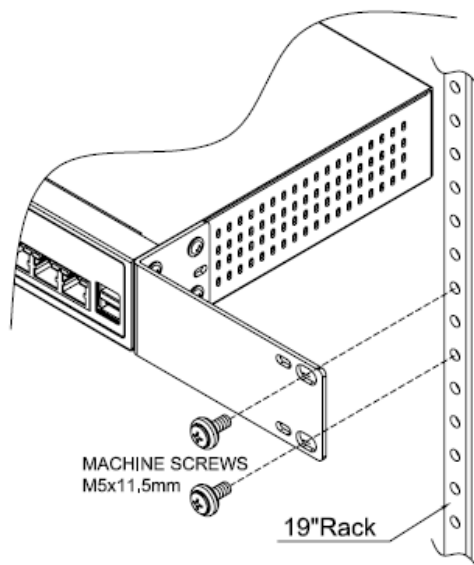

Do the following steps to mount the router on wall:

1. Attach the brackets on each side of the chassis by using the machine screws. Each side requires two screws.

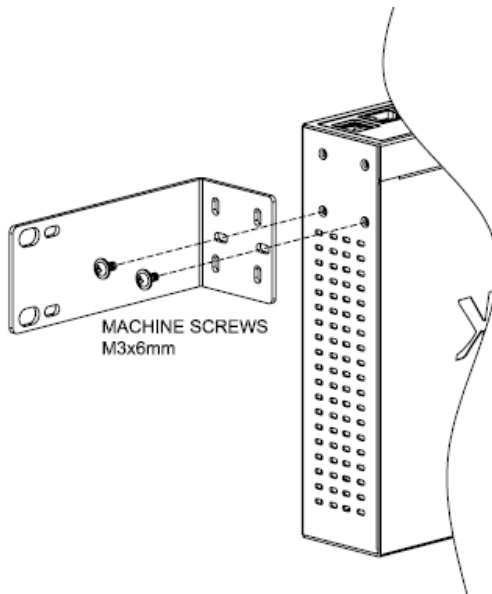

2. Locate the wall studs for attaching the router. Drill wall-mount screw holes and put the studs on the holes first.
3. Make the reserved holes on the brackets align to the studs on the wall. Use machine screws to fasten the brackets on the wall. Each side requires two screws.

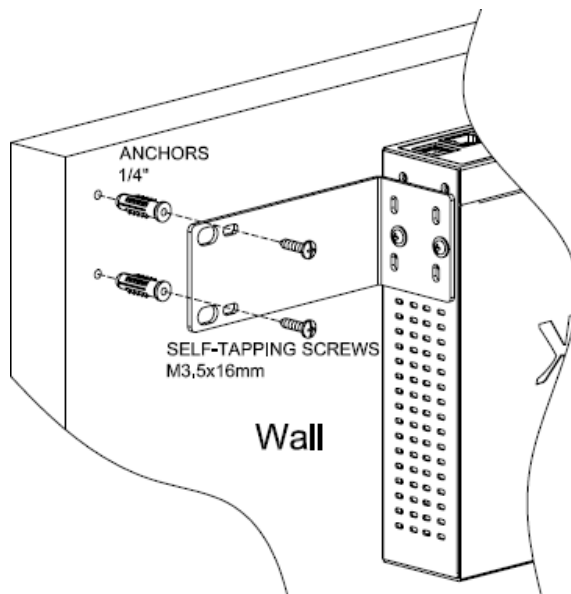

Note: Make the front and the rear of the chassis being perpendicular to the floor. The front panel should be installed upward that you can read the LEDs.

2.3 Printer Installation

You can install a printer onto the router for sharing printing. All the PCs connected this router can print documents via the router. The example provided here is made based on Windows XP/2000. For Windows 98/SE/Vista, please visit www.draytek.com.

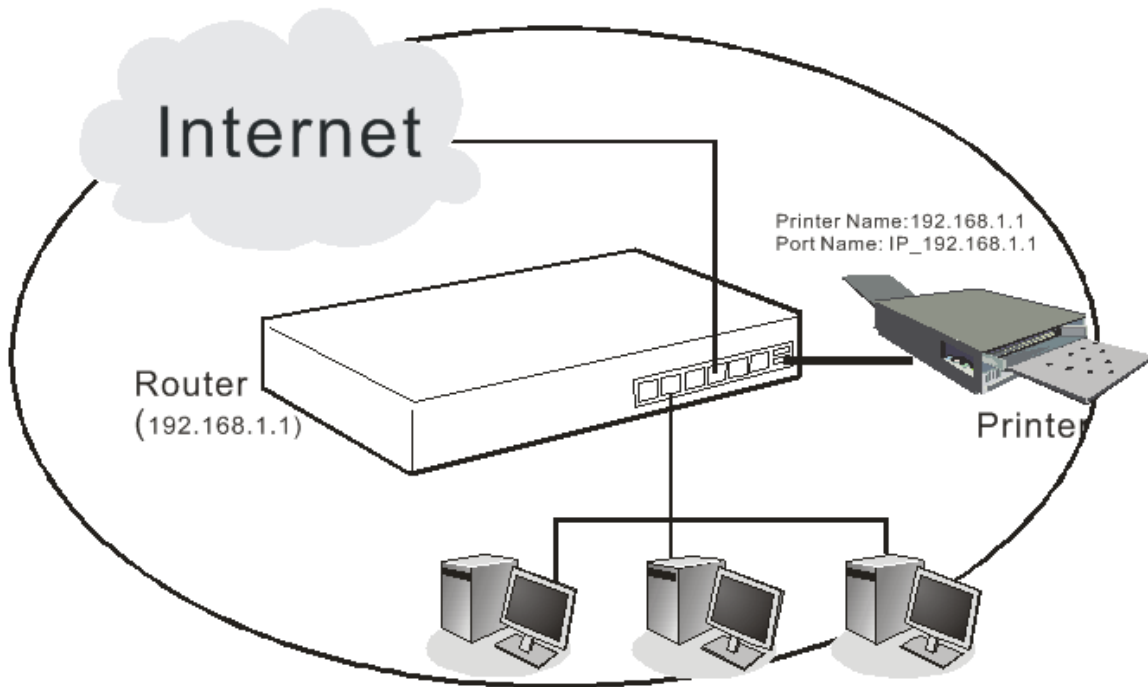

Before using it, please follow the steps below to configure settings for connected computers (or wireless clients).

1. Connect the printer with the router through USB port.
2. Open **Start->Settings-> Printer and Faxes**.

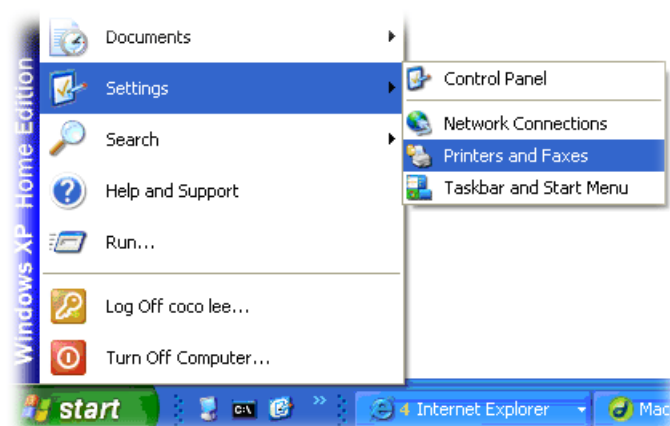

3. Open **File->Add a New Computer**. A welcome dialog will appear. Please click **Next**.

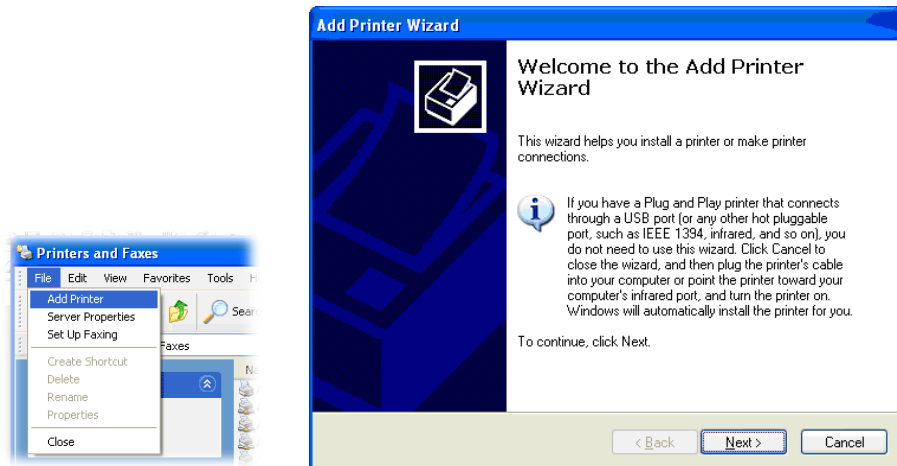

4. Click **Local printer attached to this computer** and click **Next**.



5. In this dialog, choose **Create a new port Type of port** and use the drop down list to select **Standard TCP/IP Port**. Click **Next**.

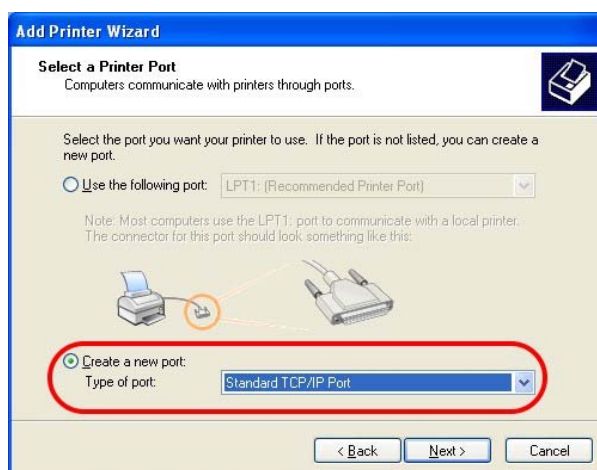

6. In the following dialog, type **192.168.1.1** (router's LAN IP) in the field of **Printer Name or IP Address** and type **IP_192.168.1.1** as the port name. Then, click **Next**.

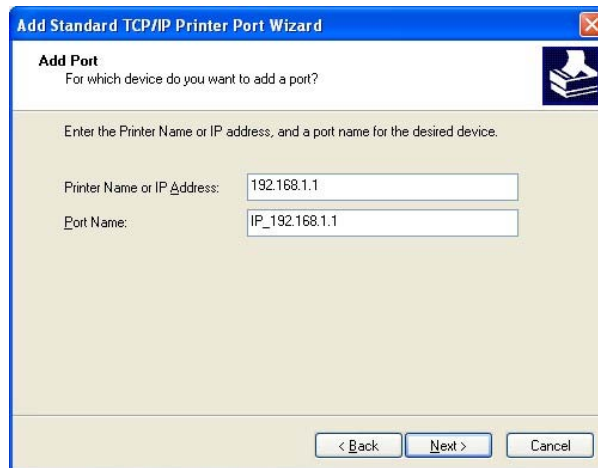

7. Click **Standard** and choose **Generic Network Card**.

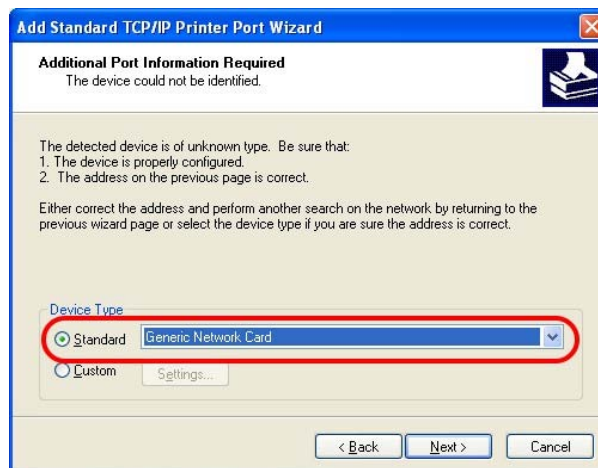

8. Then, in the following dialog, click **Finish**.



- Now, your system will ask you to choose right name of the printer that you installed onto the router. Such step can make correct driver loaded onto your PC. When you finish the selection, click **Next**.

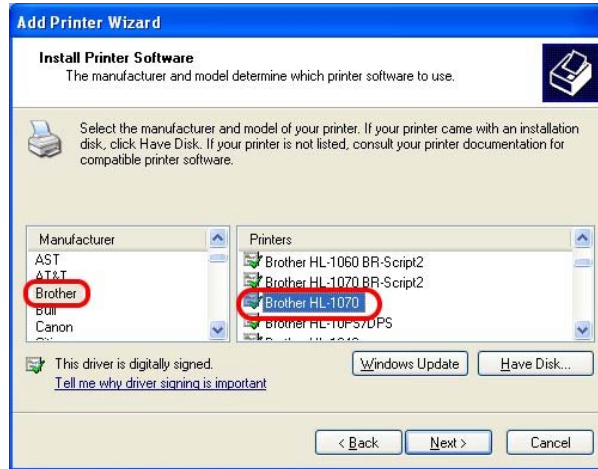

- For the final stage, you need to go back to **Control Panel-> Printers** and edit the property of the new printer you have added.

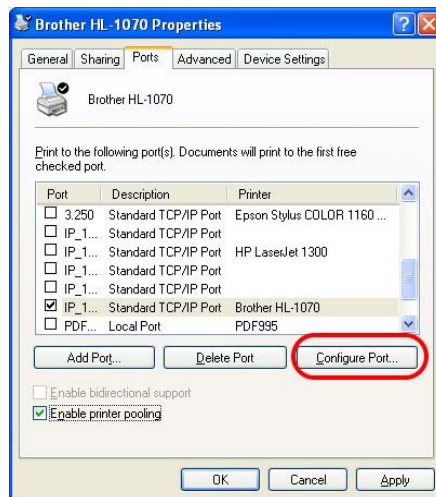

- Select "**LPR**" on Protocol, type **p1** (number 1) as Queue Name. Then click **OK**. Next please refer to the red rectangle for choosing the correct protocol and LPR name.

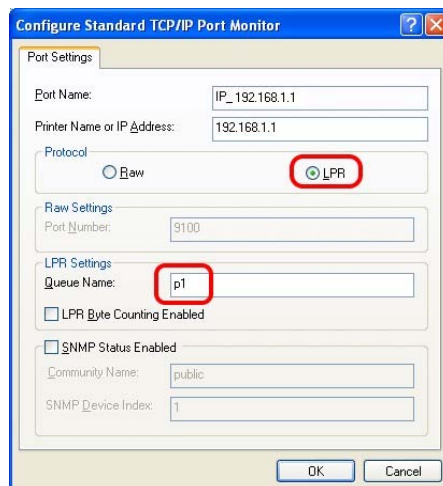

The printer can be used for printing now. Most of the printers with different manufacturers are compatible with vigor router.

Note 1: Some printers with the fax/scanning or other additional functions are not supported. If you do not know whether your printer is supported or not, please visit www.draytek.com to find out the printer list. Open **Support >FAQ**; find out the link of **Printer Server** and click it; then click the **What types of printers are compatible with Vigor router?** link.

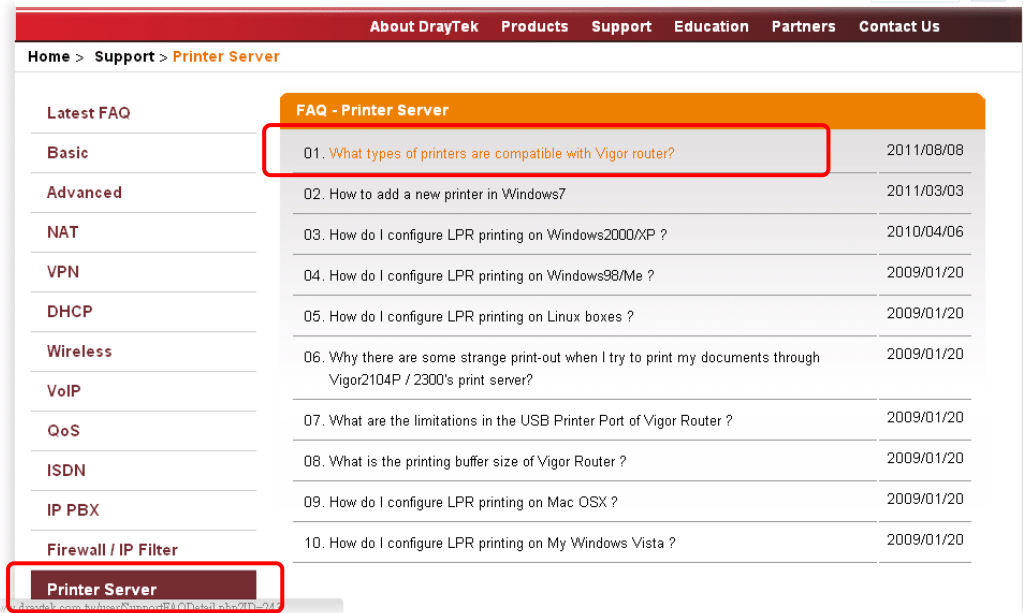

Note 2: Vigor router supports printing request from computers via LAN ports but not WAN port.

3. Configuring Web Pages

To access Internet, please finish basic configuration after completing the hardware installation.

3.1 Accessing Web Page

1. Make sure your PC connects to the router correctly.



Notice: You may either simply set up your computer to get IP dynamically from the router or set up the IP address of the computer to be the same subnet as **the default IP address of Vigor router 192.168.1.1**. For the detailed information, please refer to the later section - Trouble Shooting of the guide.

2. Open a web browser on your PC and type **http://192.168.1.1**. The following window will be open to ask for username and password.



3. Please type “admin/admin” on Username/Password and click **Login**.



Notice: If you fail to access to the web configuration, please go to “Trouble Shooting” for detecting and solving your problem.

4. The web page can be logged out according to the chosen condition. The default setting is **5Min**, which means the web configuration system will logout after five minutes without any operation. Change the setting for your necessity.

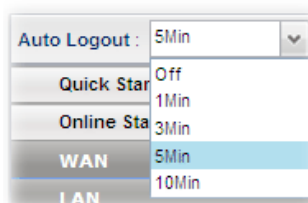

5. Now, the **Main Screen** will pop up.



3.2 Changing the Password

The first job that you have to do is changing the user password. Follow the steps below to modify:

1. Go to **System Maintenance** page and choose **Administrator Password**.

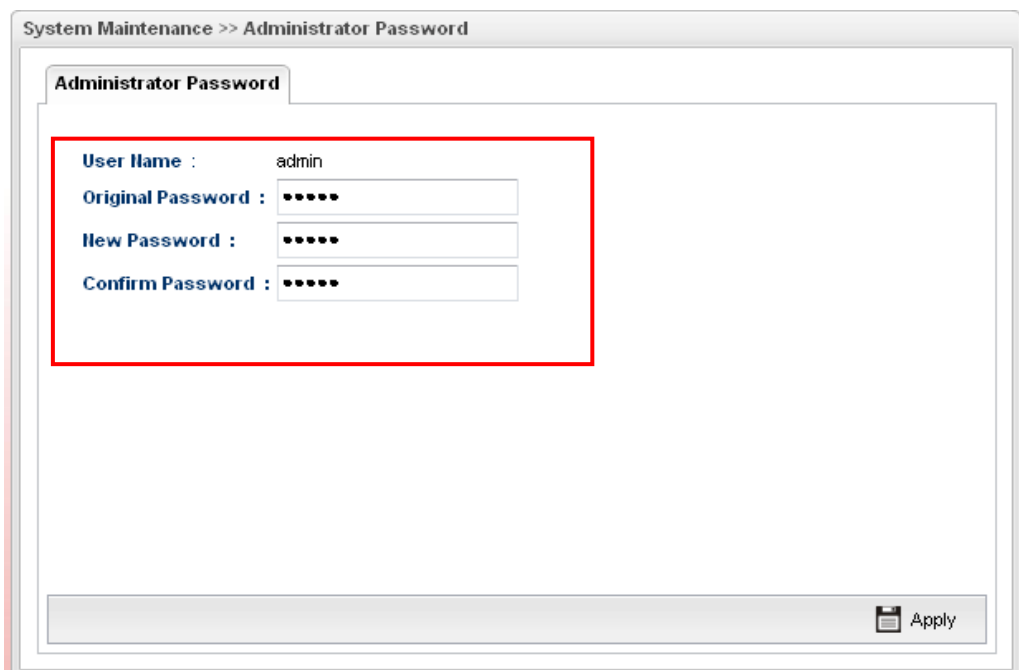

2. Enter the login password on the field of **Original Password**. Type a new one in the field of **New Password** and retype it on the field of **Confirm Password**. Then click **Apply** to continue.
3. Now, the password has been changed. Next time, use the new password to access the Web Configurator for this router.

3.3 Quick Start Wizard

Quick Setup is a wizard which is designed for configuring your router accessing Internet with simply steps. In the **Quick Setup** group, you can configure the router to access the Internet with different modes such as Static, DHCP, PPPoE, or PPTP modes.

Step 1

In the first page of Quick Start Wizard, please create a WAN profile.

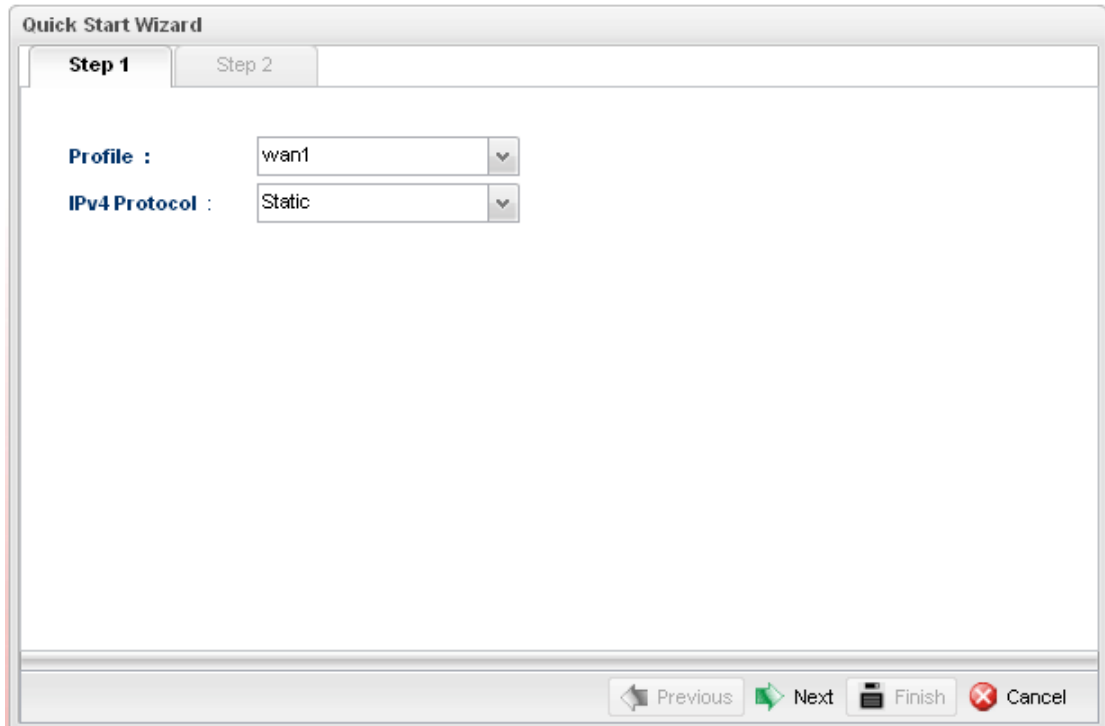

Available settings are explained as follows:

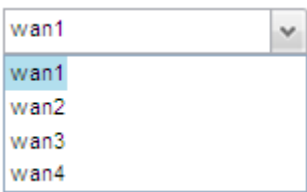
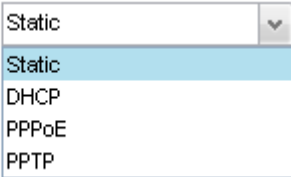
| Item | Description |
|---------------------------|---|
| Profile | <p>Use the drop down list to choose one WAN profile for configuration.</p>  |
| IPv4 Protocol Type | <p>Use the drop down list to choose a connection mode for such WAN profile.</p> <p>IPv4 Protocol : </p> <p>Static - If Static is selected, you can manually assign a static IP address to the WAN interface and complete the</p> |

| Item | Description |
|------|---|
| | <p>configuration by applying the settings and rebooting your router. Please type in values for IP address, Subnet Mask, Gateway IP Address and DNS Server IP Address specified by your ISP, and then click Next.</p> <p>DHCP - It allows a user to obtain an IP address automatically from a DHCP server on the Internet. If you choose DHCP mode, the DHCP server of your ISP will assign a dynamic IP address for Vigor300B automatically. It is not necessary for you to assign any setting. (Host Name and Domain Name are required for some ISPs).</p> <p>PPTP - This mode lets user get the IP group information by a DSL modem with PPTP service from ISP. Your service provider will give you user name, password, and authentication mode for a PPTP setting. Click PPTP as the protocol. Type in all the information that your ISP provides for this protocol.</p> <p>If your ISP offers you PPTP (Point-to-Point Tunneling Protocol) mode, please select PPTP for this router. Next, enter the required information provided by your ISP on the web page.</p> <p>PPPoE - PPPoE stands for Point-to-Point Protocol over Ethernet. It relies on two widely accepted standards: PPP and Ethernet. It connects users through an Ethernet to the Internet with a common broadband medium, such as a single DSL line, wireless device or cable modem. All the users over the Ethernet can share a common connection.</p> <p>PPPoE is used for most of DSL modem users. All local users can share one PPPoE connection for accessing the Internet. Your service provider will provide you information about user name, password, and authentication mode.</p> <p>If your ISP provides you the PPPoE (Point-to-Point Protocol over Ethernet) connection, please select PPPoE for this router to get the following page. Enter the username and password provided by your ISP on the web page.</p> |

When you finish the above settings, please click **Next** to go to next page.

Step 2



After clicking **Next**, you can see the following page which will vary according to the IPv4 protocol type selected in Step 1.

- For Static type, the page will be displayed as follows:

The screenshot shows the 'Quick Start Wizard' interface at 'Step 2'. The 'IP Address' field is set to 172.16.3.103. The 'Subnet Mask' is set to 255.255.0.0. The 'Gateway IP Address' is set to 172.16.1.1 with a trash icon and '(Optional)' next to it. Below these fields is a table for 'DNS Server IP Address' with 'Add' and 'Save' buttons. The table is currently empty, showing 'No items to show.'. At the bottom, there are 'Previous', 'Next', 'Finish', and 'Cancel' buttons.

Available settings are explained as follows:

| Item | Description |
|------------------------------|---|
| IP Address | Type the IP address of the router for the WAN profile. |
| Subnet Mask | Choose the static mask from the drop down list. |
| Gateway IP Address | Type a public gateway address for such WAN profile.  - click it to remove the IP address if you are not satisfied with it. |
| DNS Server IP Address | Type a public IP address as the primary DNS (Domain Name Server). To add a new IP address, simply Add . Four boxes will appear for you to type the IP address. When you finish the settings, click Save . |

| Item | Description |
|-----------------|---|
| |  <p>Add – Click this button to have a field for adding a new IP address.</p> <p>Save – Click this button to save the configuration.</p> <p> – click the icon to remove the selected entry.</p> |
| Previous | Click it to return to previous setting page. |
| Finish | Click it to save the configuration and exit the dialog. |
| Cancel | Click it to exit the dialog without saving the configuration. |

After finishing the above configuration, click **Finish**.

- For DHCP type, the page will be displayed as follows:

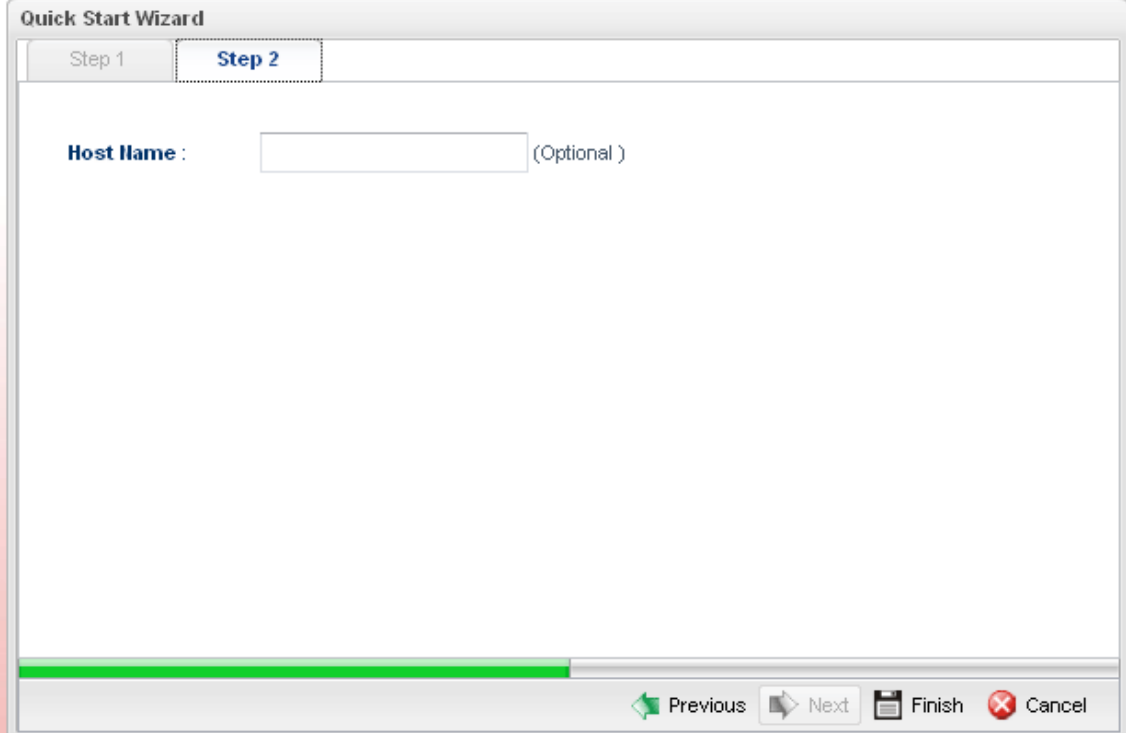

Quick Start Wizard

Step 1 Step 2

Host Name : (Optional)

Previous Next Finish Cancel

An optional setting is offered for you to type. Fill it and click **Finish**.

- For PPPoE type, the page will be displayed as follows:

Available settings are explained as follows:

| Item | Description |
|-----------------|---|
| Username | Type in the username provided by ISP in this field |
| Password | Type in the password provided by ISP in this field. |
| Previous | Click it to return to previous setting page. |
| Finish | Click it to save the configuration and exit the dialog. |
| Cancel | Click it to exit the dialog without saving the configuration. |

After finishing the above configuration, click **Finish**.

- For PPTP type, the page will be displayed as follows:

The screenshot shows the 'Quick Start Wizard' window at 'Step 2'. The configuration fields are as follows:

- PPTP Over :** Static (dropdown menu)
- Server Address :** 0.0.0.0
- Username :** [Empty text box]
- Password :** [Empty text box]
- IP Address :** 0 . 0 . 0 . 0
- Subnet Mask :** 255.255.255.0 (dropdown menu)
- Gateway IP Address :** [Empty text boxes] (Optional)
- DNS Server IP Address :** A table with the header 'DNS Server IP Address' and the content 'No items to show.' Below the table are 'Add' and 'Save' buttons.

At the bottom of the wizard, there are navigation buttons: 'Previous', 'Next', 'Finish', and 'Cancel'.

Available settings are explained as follows:

| Item | Description |
|---------------------------|--|
| PPTP Over | <p>Usually ISP dynamically assigns IP address to you each time you connect to it and request. In some case, your ISP provides service to always assign you the same IP address whenever you request. In this case, you can fill in this IP address in the Fixed IP field. Please contact your ISP before you want to use this function.</p> <p>PPTP Over : </p> <p>Server Address : </p> <p>Static – Specify the IP address. DHCP - Obtain the IP address automatically.</p> |
| Server Address | Type a remote IP address of PPTP server. |
| Username | Type in the username provided by ISP in this field. |
| Password | Type in the password provided by ISP in this field. |
| IP Address | Type a public IP address for such WAN profile. |
| Subnet Mask | Choose the static mask from the drop down list. |
| Gateway IP Address | <p>Type a public gateway address for such WAN profile.</p> <p> - click it to remove the IP address if you are not satisfied with it.</p> |

| Item | Description |
|------------------------------|---|
| DNS Server IP Address | <p>Type a public IP address as the primary DNS (Domain Name Server). To add a new IP address, simply Add. Four boxes will appear for you to type the IP address. When you finish the settings, click Save.</p> <div data-bbox="774 427 1222 584" style="text-align: center;"> </div> <p>Add – Click this button to have a field for adding a new IP address. Save – Click this button to save the configuration.  – click the icon to remove the selected entry.</p> |
| Previous | Click it to return to previous setting page. |
| Finish | Click it to save the configuration and exit the dialog. |
| Cancel | Click it to exit the dialog without saving the configuration. |

After finishing the above configuration, click **Finish**.

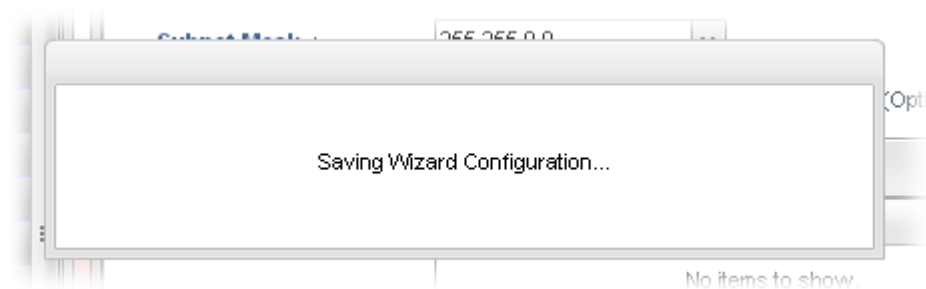

When the following screen appears, it means you have finished the Quick Start Wizard configuration.

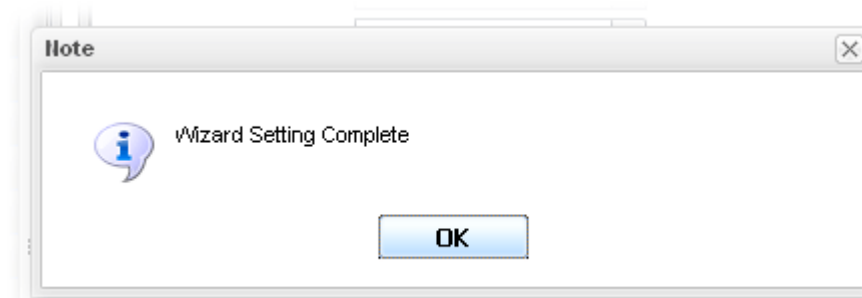

Later, you can surf the Internet at any time.

3.4 Check the Connection Status

After finishing the WAN connection, please check the connection status to ensure the network connection has been made successfully.

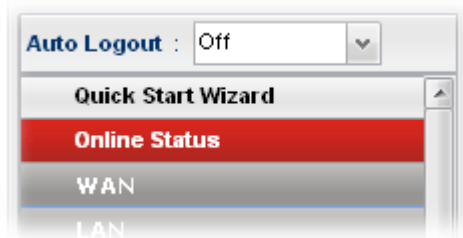

Please open **Online Status** to display the information for all the WAN interfaces at the same time, including Device Information, System Information and IPv4/IPv6 configurations.

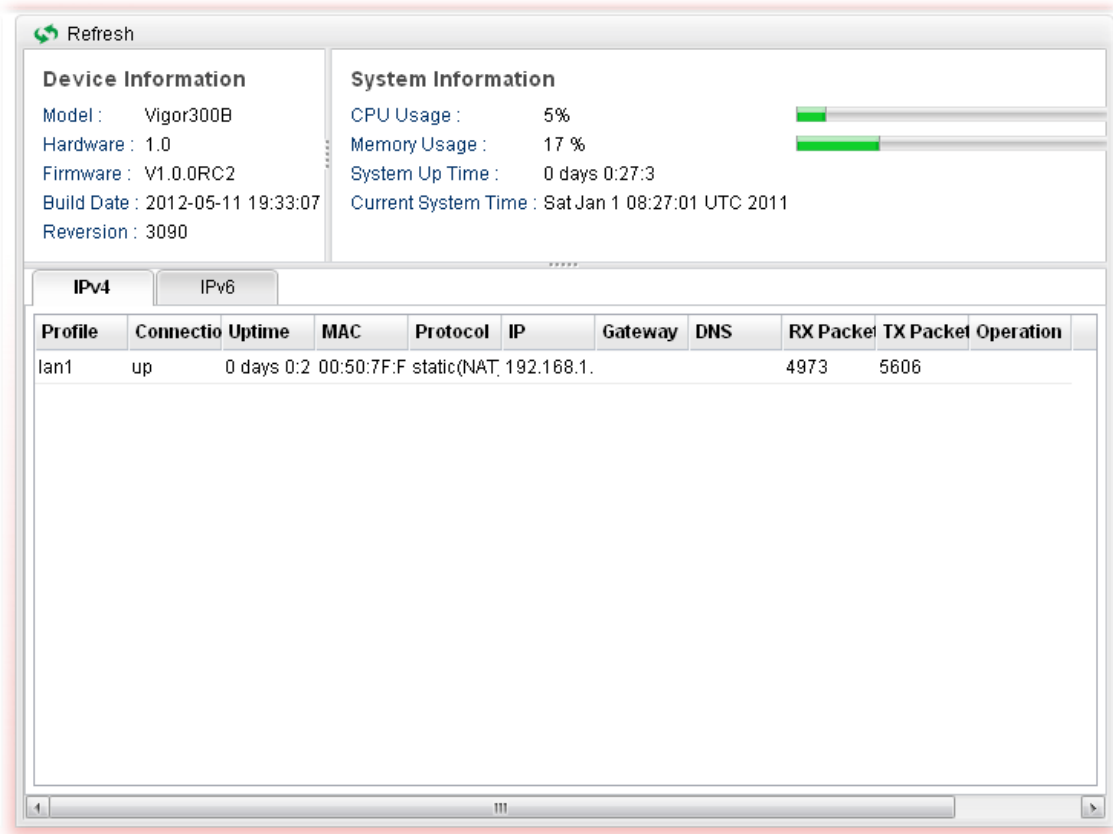

The screenshot shows the 'Online Status' page with a 'Refresh' button at the top left. It is divided into two main sections: 'Device Information' and 'System Information'.

Device Information:

- Model : Vigor300B
- Hardware : 1.0
- Firmware : V1.0.0RC2
- Build Date : 2012-05-11 19:33:07
- Reversion : 3090

System Information:

- CPU Usage : 5% (with a green progress bar)
- Memory Usage : 17 % (with a green progress bar)
- System Up Time : 0 days 0:27:3
- Current System Time : Sat Jan 1 08:27:01 UTC 2011

Below these sections, there are tabs for 'IPv4' and 'IPv6'. The 'IPv4' tab is active, showing a table of WAN connections.

| Profile | Connectio | Uptime | MAC | Protocol | IP | Gateway | DNS | RX Packet | TX Packet | Operation |
|---------|-----------|------------|------------|-------------|------------|---------|-----|-----------|-----------|-----------|
| lan1 | up | 0 days 0:2 | 00:50:7F:F | static(NAT) | 192.168.1. | | | 4973 | 5606 | |

From the above figure, wan1 connection for Internet has been built successfully for the word – **up** has been displayed on the field of **Connection**.

4. Trouble Shooting

This section will guide you to solve abnormal situations if you cannot access into the Internet after installing the router and finishing the web configuration. Please follow sections below to check your basic installation status stage by stage.

- Checking if the hardware status is OK or not.
- Checking if the network connection settings on your computer are OK or not.
- Pinging the router from your computer.
- Checking if the ISP settings are OK or not.
- Backing to factory default setting if necessary.

If all above stages are done and the router still cannot run normally, it is the time for you to contact your dealer for advanced help.

4.1 Checking If the Hardware Status Is OK or Not

Follow the steps below to verify the hardware status.

1. Check the power line and LAN cable connections. Refer to “**2.1 Hardware Installation**” for details.
2. Turn on the router. Make sure the **ACT LED** blink once per second.



3. If not, it means that there is something wrong with the hardware status. Simply back to “**2.1 Hardware Installation**” to execute the hardware installation again. And then, try again.

4.2 Checking If the Network Connection Settings on Your Computer Is OK or Not

Sometimes the link failure occurs due to the wrong network connection settings. After trying the above section, if the link is still failed, please do the steps listed below to make sure the network connection settings is OK.

For Windows



The example is based on Windows XP. As to the examples for other operation systems, please refer to the similar steps or find support notes in www.draytek.com.

1. Go to **Control Panel** and then double-click on **Network Connections**.



2. Right-click on **Local Area Connection** and click on **Properties**.

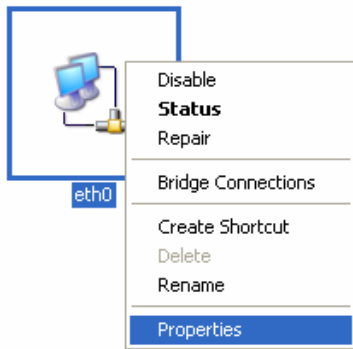

3. Select **Internet Protocol (TCP/IP)** and then click **Properties**.

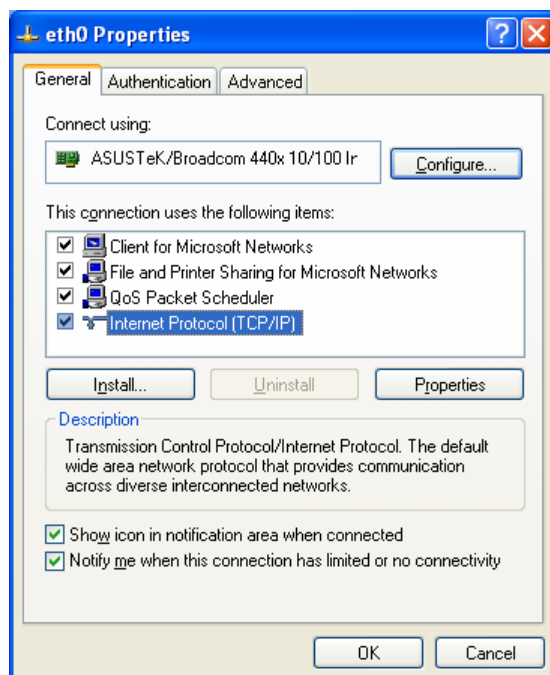

4. Select **Obtain an IP address automatically** and **Obtain DNS server address automatically**.

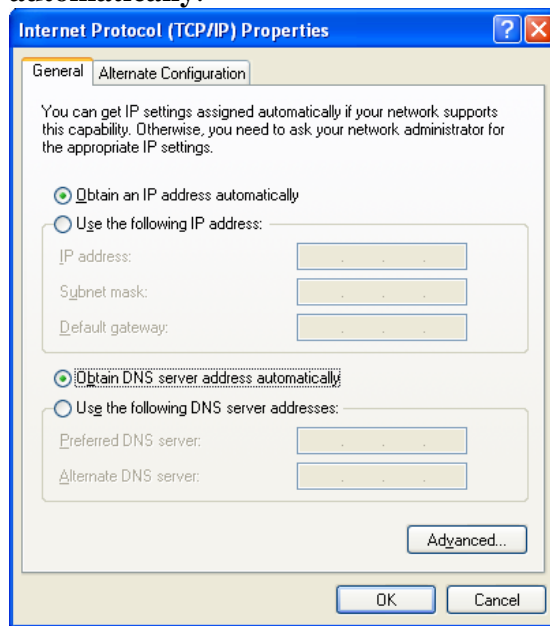

For Mac OS

1. Double click on the current used Mac OS on the desktop.
2. Open the **Application** folder and get into **Network**.
3. On the **Network** screen, select **Using DHCP** from the drop down list of Configure IPv4.

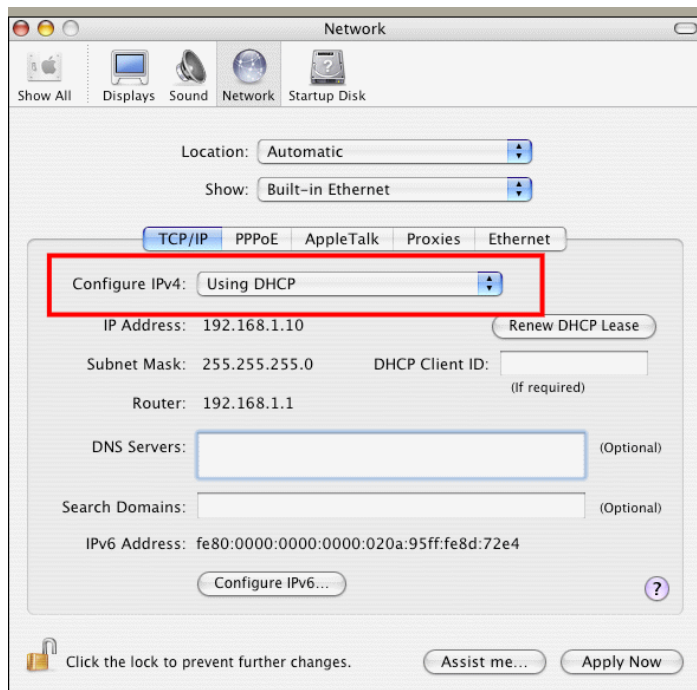

4.3 Pinging the Router from Your Computer

The default gateway IP address of the router is 192.168.1.1. For some reason, you might need to use “ping” command to check the link status of the router. **The most important thing is that the computer will receive a reply from 192.168.1.1.** If not, please check the IP address of your computer. We suggest you setting the network connection as **get IP automatically**. (Please refer to the section 4.2)

Please follow the steps below to ping the router correctly.

For Windows

1. Open the **Command Prompt** window (from **Start menu**> **Run**).
2. Type **command** (for Windows 95/98/ME) or **cmd** (for Windows NT/2000/XP/Vista/7). The DOS command dialog will appear.

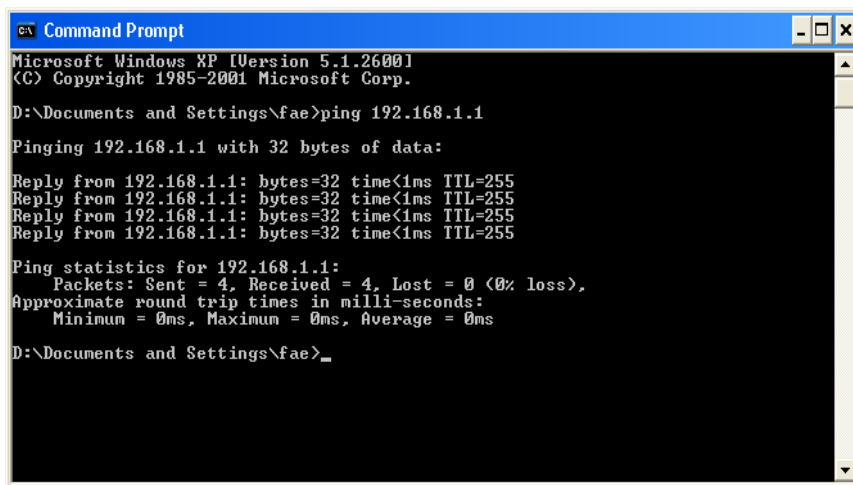

```
Microsoft Windows XP [Version 5.1.2600]
(C) Copyright 1985-2001 Microsoft Corp.

D:\Documents and Settings\fae>ping 192.168.1.1

Pinging 192.168.1.1 with 32 bytes of data:

Reply from 192.168.1.1: bytes=32 time<1ms TTL=255
Reply from 192.168.1.1: bytes=32 time<1ms TTL=255
Reply from 192.168.1.1: bytes=32 time<1ms TTL=255
Reply from 192.168.1.1: bytes=32 time<1ms TTL=255

Ping statistics for 192.168.1.1:
    Packets: Sent = 4, Received = 4, Lost = 0 (0% loss),
    Approximate round trip times in milli-seconds:
        Minimum = 0ms, Maximum = 0ms, Average = 0ms

D:\Documents and Settings\fae>
```

3. Type **ping 192.168.1.1** and press [Enter]. If the link is OK, the line of “**Reply from 192.168.1.1:bytes=32 time<1ms TTL=255**” will appear.
4. If the line does not appear, please check the IP address setting of your computer.

For Mac OS (Terminal)

1. Double click on the current used Mac OS on the desktop.
2. Open the **Application** folder and get into **Utilities**.
3. Double click **Terminal**. The Terminal window will appear.
4. Type **ping 192.168.1.1** and press [Enter]. If the link is OK, the line of “**64 bytes from 192.168.1.1: icmp_seq=0 ttl=255 time=xxxx ms**” will appear.

```
Terminal — bash — 80x24
Last login: Sat Jan  3 02:24:18 on ttty1
Welcome to Darwin!
Vigor10:~ draytek$ ping 192.168.1.1
PING 192.168.1.1 (192.168.1.1): 56 data bytes
64 bytes from 192.168.1.1: icmp_seq=0 ttl=255 time=0.755 ms
64 bytes from 192.168.1.1: icmp_seq=1 ttl=255 time=0.697 ms
64 bytes from 192.168.1.1: icmp_seq=2 ttl=255 time=0.716 ms
64 bytes from 192.168.1.1: icmp_seq=3 ttl=255 time=0.731 ms
64 bytes from 192.168.1.1: icmp_seq=4 ttl=255 time=0.72 ms
^C
--- 192.168.1.1 ping statistics ---
5 packets transmitted, 5 packets received, 0% packet loss
round-trip min/avg/max = 0.697/0.723/0.755 ms
Vigor10:~ draytek$
```

4.4 Checking If the ISP Settings are OK or Not

Open **Online Status** to check current network status. Be careful to check if the settings coming from your ISP have been typed correctly or not.

The screenshot shows the 'Online Status' page for a Vigor300B device. It includes a 'Refresh' button at the top left. The page is divided into two main sections: 'Device Information' and 'System Information'. Below these, there are tabs for 'IPv4' and 'IPv6'. A table displays network profiles with columns for Profile, Connecti, Uptime, MAC, Protocol, IP, Gateway, DNS, RX Packe, TX Packe, and Operation.

| Profile | Connecti | Uptime | MAC | Protocol | IP | Gateway | DNS | RX Packe | TX Packe | Operation |
|---------|----------|-------------------|-----------|-----------|----|---------|-----|----------|----------|-----------|
| lan1 | up | 0 days 0:00:50:7F | static(NA | 192.168.1 | | | | 271 | 270 | |

If there is something wrong with the configuration, please go to **WAN** page and choose **General Setup** again to modify the WAN connection.

The screenshot shows the 'WAN >> General Setup' page in the DrayTek Vigor300B web interface. The page has a red header with the DrayTek logo, 'Vigor300B', the time '15:54:43', and 'Login: Admin'. On the left, there is a navigation menu with 'General Setup' highlighted. The main content area shows a table of WAN profiles with columns for Profile, Enable This, Description, VLAN ID, VLAN Tag, Port, IPv4 Protocol, and IPv6 Protocol.

| Profile | Enable This | Description | VLAN ID | VLAN Tag | Port | IPv4 Protocol | IPv6 Protocol |
|---------|-------------|-------------|---------|----------|------|---------------|---------------|
| wan1 | false | | 10 | Disable | WAN1 | None | Link-Local |
| wan2 | false | | 11 | Disable | WAN2 | None | Link-Local |
| wan3 | false | | 12 | Disable | WAN3 | None | Link-Local |
| wan4 | false | | 13 | Disable | WAN4 | None | Link-Local |

4.5 Backing to Factory Default Setting If Necessary

Sometimes, a wrong connection can be improved by returning to the default settings. Try to reset the router by software or hardware.



Warning: After pressing **factory default setting**, you will lose all settings you did before. Make sure you have recorded all useful settings before you pressing. The password of factory default is null.

Software Reset

You can reset the router to factory default via Web page.

Go to **System Maintenance** and choose **Reboot System** on the web page. The following screen will appear. Choose **Reboot with Factory Default Configuration** and click **Reboot**. After few seconds, the router will return all the settings to the factory settings.

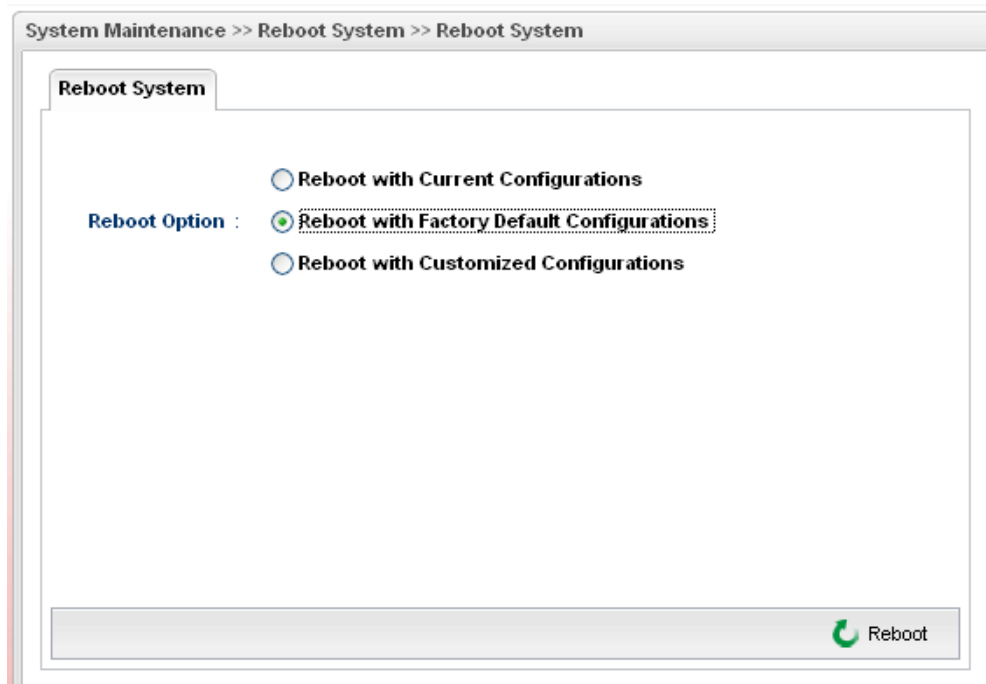

Hardware Reset

While the router is running (ACT LED blinking), press the **Factory Reset** button and hold for more than 5 seconds. When you see the **ACT** LED blinks rapidly, please release the button. Then, the router will restart with the default configuration.



After restore the factory default setting, you can configure the settings for the router again to fit your personal request.

4.6 Contacting Your Dealer

If the router still cannot work correctly after trying many efforts, please contact your dealer for further help right away. For any questions, please feel free to e-mail to support@draytek.com.