

DrayTek

Vigor2962 Series

2.5G Security VPN Router



QUICK START GUIDE

V1.5

Vigor2962 Series 2.5G Security VPN Router Quick Start Guide

Version:1.5

Firmware Version: V4.3.2.4

(For future update, please visit DrayTek web site)

Date: July 7, 2023

Intellectual Property Rights (IPR) Information

Copyrights

© All rights reserved. This publication contains information that is protected by copyright. No part may be reproduced, transmitted, transcribed, stored in a retrieval system, or translated into any language without written permission from the copyright holders.

Trademarks

The following trademarks are used in this document:

- Microsoft is a registered trademark of Microsoft Corp.
- Windows, Windows 8, 10, 11 and Explorer are trademarks of Microsoft Corp.
- Apple and Mac OS are registered trademarks of Apple Inc.
- Other products may be trademarks or registered trademarks of their respective manufacturers.

Safety Instructions and Approval

Safety Instructions

- Read the installation guide thoroughly before you set up the router.
- The router is a complicated electronic unit that may be repaired only by authorized and qualified personnel. Do not try to open or repair the router yourself.
- Do not place the router in a damp or humid place, e.g. a bathroom.
- Do not stack the routers.
- The router should be used in a sheltered area, within a temperature range of +5 to +40 Celsius.
- Do not expose the router to direct sunlight or other heat sources. The housing and electronic components may be damaged by direct sunlight or heat sources.
- Do not deploy the cable for LAN connection outdoor to prevent electronic shock hazards.
- Do not power off the device when saving configurations or firmware upgrades. It may damage the data in a flash. Please disconnect the Internet connection on the device before powering it off when a TR-069/ACS server manages the device.
- Keep the package out of reach of children.
- When you want to dispose of the router, please follow local regulations on conservation of the environment.

Warranty

We warrant to the original end user (purchaser) that the router will be free from any defects in workmanship or materials for a period of two (2) years from the date of purchase from the dealer. Please keep your purchase receipt in a safe place as it serves as proof of date of purchase. During the warranty period, and upon proof of purchase, should the product have indications of failure due to faulty workmanship and/or materials, we will, at our discretion, repair or replace the defective products or components, without charge for either parts or labor, to whatever extent we deem necessary to restore the product to proper operating condition. Any replacement will consist of a new or re-manufactured functionally equivalent product of equal value, and will be offered solely at our discretion. This warranty will not apply if the product is modified, misused, tampered with, damaged by an act of God, or subjected to abnormal working conditions. The warranty does not cover the bundled or licensed software of other vendors. Defects which do not significantly affect the usability of the product will not be covered by the warranty. We reserve the right to revise the manual and online documentation and to make changes from time to time in the contents hereof without obligation to notify any person of such revision or changes.



EU Declaration of Conformity

We DrayTek Corp., office at No.26, Fushing Rd., Hukou, Hsinchu Industrial Park, Hsinchu 303, Taiwan, declare under our sole responsibility that the product

- Product name: 2.5G Security VPN Router
- Model number: Vigor2962, Vigor2962P
- Manufacturer: DrayTek Corp.
- Address: No.26, Fushing Rd., Hukou, Hsinchu Industrial Park, Hsinchu 303, Taiwan

is in conformity with the relevant Union harmonisation legislation:

EMC Directive 2014/30/EU, Low Voltage Directive 2014/35/EU and RoHS 2011/65/EU with reference to the following standards

Standard	Version / Issue date
EN 55032	2015+AC:2016 class A
EN 61000-3-3	2013+A1:2019
EN 55035	2017
EN 62368-1	2014+A11:2017
EN IEC 63000:2018	2018



Hsinchu
(place)

9th September, 2020
(date)

Calvin Ma / President
(Legal Signature)



Declaration of Conformity

We DrayTek Corp., office at No.26, Fushing Rd., Hukou, Hsinchu Industrial Park, Hsinchu 303, Taiwan, declare under our sole responsibility that the product

- Product name: 2.5G Security VPN Router
- Model number: Vigor2962, Vigor2962P
- Manufacturer: DrayTek Corp.
- Address: No.26, Fushing Rd., Hukou, Hsinchu Industrial Park, Hsinchu 303, Taiwan.
- Importer: CMS Distribution Ltd: Bohola Road, Kiltimagh, Co Mayo, Ireland

is in conformity with the relevant UK Statutory Instruments:

The Electromagnetic Compatibility Regulations 2016 (SI 2016 No.1091), The Electrical Equipment (Safety) Regulations 2016 (SI 2016 No.1101), and The Restriction of the Use of Certain Hazardous Substances in Electrical and Electronic Equipment Regulations 2012 (SI 2012 No. 3032) with reference to the following standards:

Standard	Version / Issue date
EN 55032	2015+A1:2016 class A
EN 61000-3-3	2013+A1:2019
EN 55035	2017
EN 62368-1	2014/A11:2017
EN IEC 63000:2018	2018



Hsinchu
(place)

2nd August, 2021
(date)

Calvin Ma / President
(Legal Signature)

Regulatory Information

Federal Communication Commission Interference Statement

This equipment has been tested and found to comply with the limits for a Class A digital device, pursuant to Part 15 of the FCC Rules. These limits are designed to provide reasonable protection against harmful interference in a residential installation. This equipment generates, uses and can radiate radio frequency energy and, if not installed and used in accordance with the instructions, may cause harmful interference to radio communications. However, there is no guarantee that interference will not occur in a particular installation. If this equipment does cause harmful interference to radio or television reception, which can be determined by turning the equipment off and on, the user is encouraged to try to correct the interference by one of the following measures:

- Reorient or relocate the receiving antenna.
- Increase the separation between the equipment and receiver.
- Connect the equipment into an outlet on a circuit different from that to which the receiver is connected.
- Consult the dealer or an experienced radio/TV technician for help.

This device complies with Part 15 of the FCC Rules. Operation is subject to the following two conditions:

- (1) This device may not cause harmful interference, and
- (2) This device may accept any interference received, including interference that may cause undesired operation.



More update, please visit www.draytek.com.

USA Local Representative	Company name	ABP International Inc.		
	Address	13988 Diplomat Drive Suite 180 Dallas TX 75234		
	ZIP Code	75234	E-mail	itadmin@abptech.com
	Contact Person	Mr. Henry N Castillo	Tel.	(972)831-1600 140

Table of Contents

1. Package Content	1
2. Panel Explanation.....	2
2.1 LED for Vigor2962 and Vigor2962P	2
2.2 Connectors for Vigor2962 and Vigor2962P	3
3. Hardware Installation	4
3.1 Connecting Device	4
3.2 Wall-Mounted and Rack-Mounted Installation	5
4. Software Configuration	6
4.1 Quick Start Wizard for Network Connection.....	6
5. Customer Service	13
Be a Registered Owner	13
Firmware & Tools Updates	13

1. Package Content

Take a look at the package content. If there is anything missed or damaged, please contact DrayTek or dealer immediately.



Vigor router

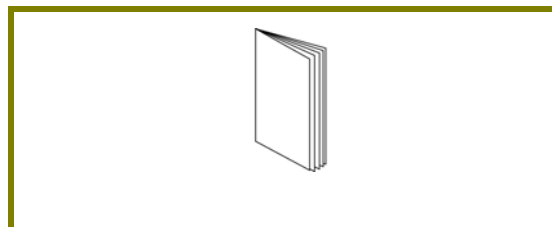

Quick Start Guide

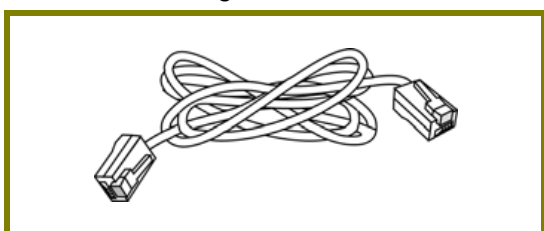

RJ-45 Cable (Ethernet)

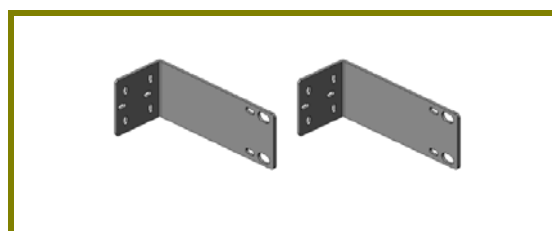

Standard brackets

The type of the power cord depends on the country that the router will be installed.

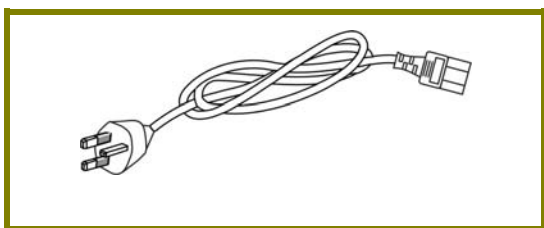

UK-type Power Cord

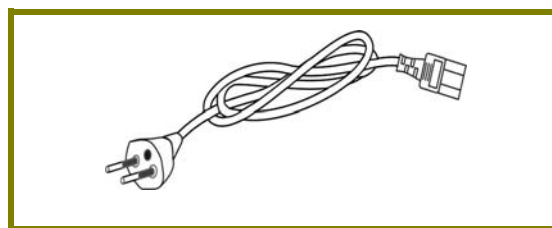

EU-type Power Cord

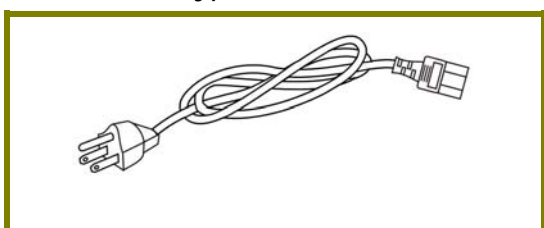

USA/Taiwan-type Power Cord

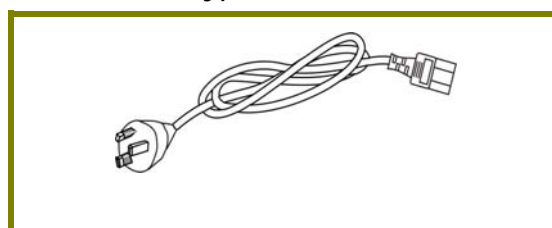

AU/NZ-type Power Cord



Note

Input Rated for Vigor2962: 100~240V, 50/60Hz, 0.7A
Input Rated for Vigor2962P: 100~240V, 50/60Hz, 1.5A

2. Panel Explanation

2.1 LED for Vigor2962 and Vigor2962P

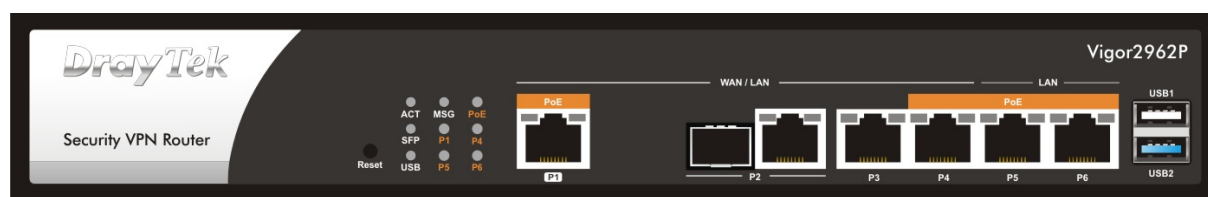
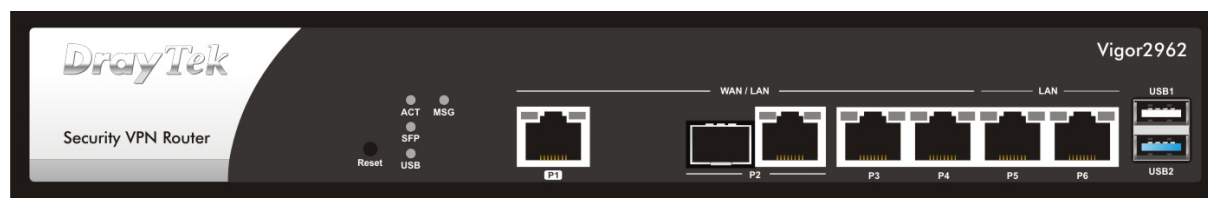

LED	Status	Explanation	
ACT	Blinking	The router is powered on and running normally.	
	Off	The router is powered off.	
SFP	On	The fiber connection is established.	
	Blinking	The data is transmitting.	
	Off	No fiber connection is established or the system is hanged.	
USB	On	The USB device is installed and ready.	
	Off	No USB device is installed.	
MSG	On / Off / Blinking	MSG means this LED is user-defined. It will be on / off / blinking according to the rule defined on WUI.	
PoE (for 2962P)	On	Power sourcing equipment for PoE is enabled.	
	Off	Power sourcing equipment for PoE is disabled.	
P1, P4, P5, P6 (for 2962P)	On	A PoE equipment is connected to port P1, P4, P5 or P6.	
	Off	No PoE equipment connected.	
P1	Left	On	The Ethernet link is established.
		Off	No Ethernet link is established.
		Blinking	The data is transmitting.
	Right	On	The Ethernet link is established with 1/2.5Gbps.
		Off	The Ethernet link is established with less than 1Gbps.
		Blinking	The data is transmitting.
P2 (Right) ~P6	Left	On	The Ethernet link is established on corresponding port.
		Off	No Ethernet link is established.
		Blinking	The data is transmitting.
	Right	On	The Ethernet link is established on corresponding port with 1Gbps.
		Off	The Ethernet link is established on corresponding port with less than 1Gbps.
		Blinking	The data is transmitting.

2.2 Connectors for Vigor2962 and Vigor2962P

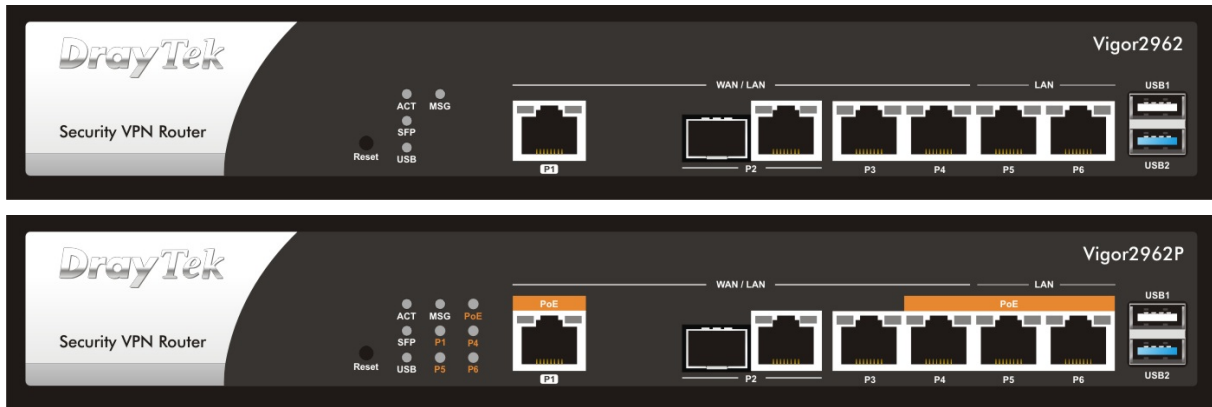

Interface	Description
Reset	The Factory Reset button is used to restore the default settings. Turn on the router (ACT LED is blinking). Press the hole and keep for more than 5 seconds. When you see the ACT LED begins to blink rapidly than usual, release the button. Then the router will restart with the factory default configuration.
P1	Connector for local network devices (LAN) or a modem for accessing Internet (WAN).
P2 (Left)	Connector for SFP module with the rate of 1G bps.
P2 (Right)~P4	Connectors for remote network devices or local network devices (WAN/LAN) with the rate of 1G/100M/10M bps. Or connector for a modem for accessing Internet (WAN).
P5~P6	Connectors for local network devices (LAN) with the rate of 1G/100M/10M bps.
USB1~2	Connector for the USB device.
	Connector for a power cord. ON/OFF - Power switch.



Note 1

P1 to P4 port can be configurable as WAN / LAN interface. At least, up to two of them can be set as the WAN port at one time.
For Vigor2962P, P1, P4, P5 and P6 also can be connected by PoE equipments.

Note 2

The PoE Power budget is up to 60W.

3. Hardware Installation

This section will guide you to install the router through hardware connection and configure the router's settings through web browser.

3.1 Connecting Device

Before starting to configure the router, you have to connect your devices correctly.

1. Connect a modem to any WAN port of Vigor2962 with Ethernet cable (RJ-45) to access Internet.
2. Connect the other end of the cable (RJ-45) to the Ethernet port on your computer (that device also can connect to other computers to form a small area network). The LAN LED for that port on the front panel will light up.
3. Connect the power cord to Vigor2962's power port on the rear panel, and the other side into a wall outlet.
4. Power on the device by pressing down the power switch on the rear panel. The PWR LED should be ON.
5. The system starts to initiate. After completing the system test, the ACT LED will light up and start blinking.

Below shows an outline of the hardware installation for your reference.

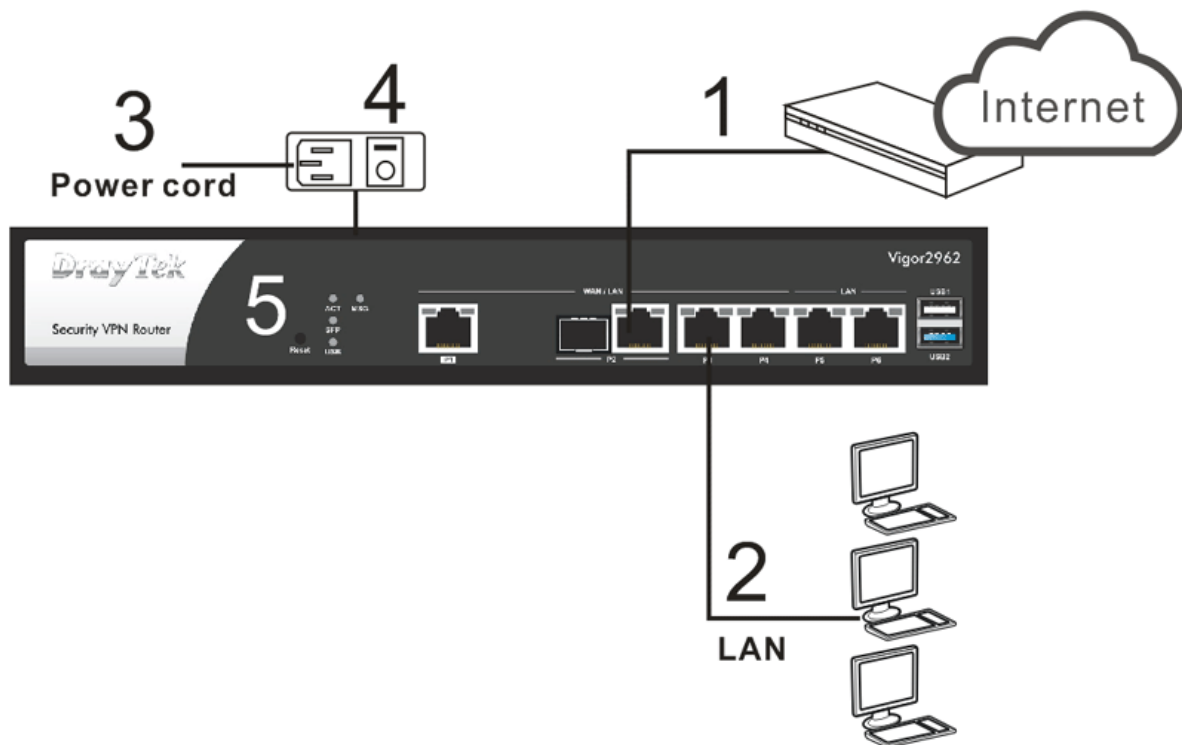

3.2 Wall-Mounted and Rack-Mounted Installation

The Vigor2962 Series can be mounted on the shelf or on the wall by using standard brackets shown below.

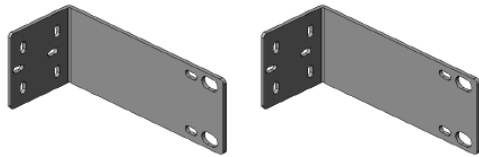

Wall-Mounted

1. Choose a flat surface (on the wall) which is suitable for placing the router. Make the screw holes on the short side of the bracket aim at the screw holes on the router. Next, fasten both the bracket and the router with two screws; and fasten both the wall and the bracket with another two screws. Refer to the following figure.
2. Then, continue to fasten the screws on the other side of the router and the wall with other screws.
3. When you finished about procedure, the router has been mounted on the wall firmly.

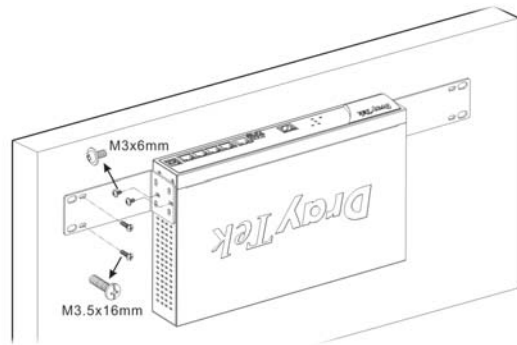

Rack-Mounted

1. Fasten the rack mount kit on both sides of the Vigor router using specific screws.
2. Then, install the Vigor router (with rack mount kit) on the 19-inch chassis by using other four screws.

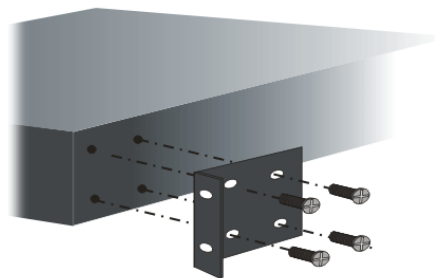

4. Software Configuration

To access Internet, please finish basic configuration after completing the hardware installation.

4.1 Quick Start Wizard for Network Connection

The **Quick Start Wizard** is designed for you to easily set up your router for Internet access. You can directly access the **Quick Start Wizard** via Web User Interface. Make sure your PC connects to the router correctly.



Note

You may either simply set up your computer to get IP dynamically from the router or set up the IP address of the computer to be the same subnet as the **default IP address of Vigor router 192.168.1.1**. For the detailed information, please refer to - Trouble Shooting of the user's guide.

Open a web browser on your PC and type **http://192.168.1.1**. A pop-up window will open to ask for username and password. Please enter "admin/admin" as the Username/Password and click **Login**.

DrayTek
Vigor2962

Username
admin

Password
.....

Login

Copyright © 2021 DrayTek Corp



Note

If you fail to access to the web configuration, please go to "Trouble Shooting" on User's Guide for detecting and solving your problem.

Now, the Main Screen will pop up. Click **Wizards>>Quick Start Wizard**.

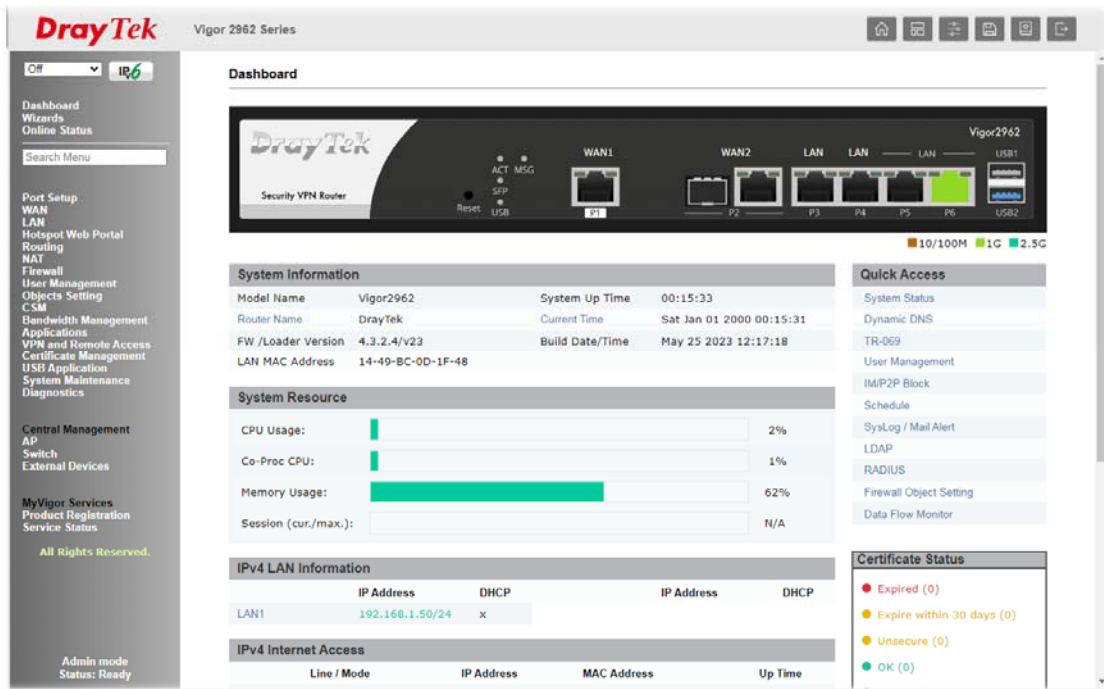

Note

The home page will change slightly in accordance with the router you have.

If your router can be under an environment with high speed NAT, the configuration provide here can help you to deploy and use the router quickly. The first screen of **Quick Start Wizard** is entering login password. After typing the password, please click **Next**.

Quick Start Wizard

Enter login password

Please enter an alpha-numeric string as your **Password** (Max 83 characters)

Old Password

New Password

Confirm Password

Password Strength: Weak Medium Strong

Strong password requirements:

1. Have at least one upper-case letter and one lower-case letter.
2. Including non-alphanumeric characters is a plus.

Hint: If you want to keep the password unchanged, leave the password blank and press "Next" button to skip this process.

< Back Next > Finish Cancel

On the next page as shown below, please select the WAN interface that you use. Then click Next for next step.

Quick Start Wizard

Select WAN Interface

Select WAN Interface:	<input type="text" value="WAN1"/>
Display Name:	<input type="text"/>
Physical Mode:	Ethernet
Physical Type:	<input type="text" value="Auto negotiation"/>

You have to select the appropriate Internet access type (PPPoE, Static IP or DHCP) according to the information from your ISP.

Here we take PPPoE and DHCP modes for WAN connection as examples.

For PPPoE Connection

1. Choose WAN1 as WAN Interface and click the Next button; you will get the following page.

Quick Start Wizard

Connect to Internet

WAN 1
Select one of the following Internet Access types provided by your ISP.

PPPoE
 Static IP
 DHCP

< Back Next > Finish Cancel

2. Select PPPoE and click Next to get the following page.

Quick Start Wizard

PPPoE Client Mode

WAN 1
Enter the user name and password provided by your ISP.

Service Name (optional)	<input type="text"/>
Username	<input type="text" value="84005657@hinet.net"/>
Password	<input type="password" value="*****"/>
Confirm Password	<input type="password" value="*****"/>

< Back Next > Finish Cancel

3. Enter the Username/Password provided by your ISP. Then click **Next** for viewing the summary of such connection.

Quick Start Wizard

Please confirm your settings:

WAN Interface:	WAN1
Physical Mode:	Ethernet
Internet Access:	PPPoE

Click **Back** to modify changes if necessary. Otherwise, click **Finish** to save the current settings and restart the Vigor router.

4. Click **Finish**. A page of **Quick Start Wizard Setup OK!!!** will appear. Then, the system status of this protocol will be shown.

Quick Start Wizard Setup OK!

5. Now, you can enjoy surfing on the Internet.

For DHCP Connection

1. Choose WAN1 as WAN Interface and click the Next button; you will get the following page.

Quick Start Wizard

Connect to Internet

WAN 1
Select one of the following Internet Access types provided by your ISP.

PPPoE
 Static IP
 DHCP

2. Select DHCP and click Next to get the following page.

Quick Start Wizard

DHCP Client Mode

WAN 1
If your ISP requires you to enter a specific host name or specific MAC address, please enter it in.

Host Name (optional)

MAC - - - - - (optional)

3. Enter the hostname and / or MAC address provided by your ISP. Then click **Next** for viewing summary of such connection.

Quick Start Wizard

Please confirm your settings:

WAN Interface:	WAN1
Physical Mode:	Ethernet
Internet Access:	DHCP

Click **Back** to modify changes if necessary. Otherwise, click **Finish** to save the current settings and restart the Vigor router.

4. Click **Finish**. A page of **Quick Start Wizard Setup OK!!!** will appear. Then, the system status of this protocol will be shown.

Quick Start Wizard Setup OK!

5. Now, you can enjoy surfing on the Internet.

5. Customer Service

If the router cannot work correctly after trying many efforts, please contact your dealer for further help right away. For any questions, please feel free to send e-mail to support@draytek.com.

Be a Registered Owner

Web registration is preferred. You can register your Vigor router via <https://myvigor.draytek.com>.

Firmware & Tools Updates

Due to the continuous evolution of DrayTek technology, all routers will be regularly upgraded. Please consult the DrayTek web site for more information on newest firmware, tools and documents.

<https://www.draytek.com>

GPL Notice

This DrayTek product uses software partially or completely licensed under the terms of the GNU GENERAL PUBLIC LICENSE. The author of the software does not provide any warranty. A Limited Warranty is offered on DrayTek products. This Limited Warranty does not cover any software applications or programs.

To download source codes please visit:

<http://gplsource.draytek.com>

GNU GENERAL PUBLIC LICENSE:

<https://gnu.org/licenses/gpl-2.0>

Version 2, June 1991

For any question, please feel free to contact DrayTek technical support at support@draytek.com for further information.