

DrayTek

Vigor2133

Gigabit Broadband Router



Quick Start Guide

V1.1

Vigor2133

Gigabit Broadband Router

Quick Start Guide

Version: 1.1

Firmware Version: V3.8.7

(For future update, please visit [DrayTek web site](#))

Date: March 6, 2018

Intellectual Property Rights (IPR) Information

Copyrights

© All rights reserved. This publication contains information that is protected by copyright. No part may be reproduced, transmitted, transcribed, stored in a retrieval system, or translated into any language without written permission from the copyright holders.

Trademarks

The following trademarks are used in this document:

- Microsoft is a registered trademark of Microsoft Corp.
- Windows, Windows 95, 98, Me, NT, 2000, XP, Vista, 7, 8 and Explorer are trademarks of Microsoft Corp.
- Apple and Mac OS are registered trademarks of Apple Inc.
- Other products may be trademarks or registered trademarks of their respective manufacturers.

Safety Instructions and Approval

Safety Instructions

- Read the installation guide thoroughly before you set up the router.
- The router is a complicated electronic unit that may be repaired only by authorized and qualified personnel. Do not try to open or repair the router yourself.
- Do not place the router in a damp or humid place, e.g. a bathroom.
- Do not stack the routers.
- The router should be used in a sheltered area, within a temperature range of 0 to +45 Celsius.
- Do not expose the router to direct sunlight or other heat sources. The housing and electronic components may be damaged by direct sunlight or heat sources.
- Do not deploy the cable for LAN connection outdoor to prevent electronic shock hazards.
- Keep the package out of reach of children.
- When you want to dispose of the router, please follow local regulations on conservation of the environment.

Warranty

We warrant to the original end user (purchaser) that the router will be free from any defects in workmanship or materials for a period of two (2) years from the date of purchase from the dealer. Please keep your purchase receipt in a safe place as it serves as proof of date of purchase. During the warranty period, and upon proof of purchase, should the product have indications of failure due to faulty workmanship and/or materials, we will, at our discretion, repair or replace the defective products or components, without charge for either parts or labor, to whatever extent we deem necessary to restore the product to proper operating condition. Any replacement will consist of a new or re-manufactured functionally equivalent product of equal value, and will be offered solely at our discretion. This warranty will not apply if the product is modified, misused, tampered with, damaged by an act of God, or subjected to abnormal working conditions. The warranty does not cover the bundled or licensed software of other vendors. Defects which do not significantly affect the usability of the product will not be covered by the warranty. We reserve the right to revise the manual and online documentation and to make changes from time to time in the contents hereof without obligation to notify any person of such revision or changes.



EU Declaration of Conformity

We DrayTek Corp. , office at No.26, Fu Shing Road, HuKou County, Hsin-Chu Industry Park, Hsinchu 300, Taiwan , R.O.C., declare under our sole responsibility that the product

- **Product name:** Gigabit Broadband Router
- **Model number:** Vigor2133
- **Manufacturer:** DrayTek Corp.
- **Address:** No.26, Fu Shing Road, HuKou County, Hsin-Chu Industry Park, Hsinchu 300, Taiwan , R.O.C.

is in conformity with the relevant Union harmonisation legislation:

EMC Directive 2014/30/EU , Low Voltage Directive 2014/35/EU , ErP 2009/125/EC and RoHS 2011/65/EU with reference to the following standards

Standard	Version / Issue date
EN 55032	2012+AC:2013 class B
EN 61000-3-2	2014 Class A
EN 61000-3-3	2013
EN 55024	2010+A1:2015
EN 60950-1	2006 +A11:2009 +A1:2010 +A12:2011+ A2:2013
EC No. 1275/2008	2008

Hsinchu
(place)

22nd June, 2017
(date)

Calvin Ma / President
(Legal Signature)



Regulatory Information

Federal Communication Commission Interference Statement

This equipment has been tested and found to comply with the limits for a Class B digital device, pursuant to Part 15 of the FCC Rules. These limits are designed to provide reasonable protection against harmful interference in a residential installation. This equipment generates, uses and can radiate radio frequency energy and, if not installed and used in accordance with the instructions, may cause harmful interference to radio communications. However, there is no guarantee that interference will not occur in a particular installation. If this equipment does cause harmful interference to radio or television reception, which can be determined by turning the equipment off and on, the user is encouraged to try to correct the interference by one of the following measures:

- Reorient or relocate the receiving antenna.
- Increase the separation between the equipment and receiver.
- Connect the equipment into an outlet on a circuit different from that to which the receiver is connected.
- Consult the dealer or an experienced radio/TV technician for help.

This device complies with Part 15 of the FCC Rules. Operation is subject to the following two conditions:

(1) This device may not cause harmful interference, and

(2) This device may accept any interference received, including interference that may cause undesired operation.

Any changes or modifications not expressly approved by the party responsible for compliance could void the user's authority to operate this equipment.

This equipment complies with FCC radiation exposure limits set forth for an uncontrolled environment. This equipment should be installed and operated with minimum distance 20cm between the radiator and your body.



More update, please visit www.draytek.com.

Be a Registered Owner

Web registration is preferred. You can register your Vigor router via <http://www.draytek.com>.

Firmware & Tools Updates

Due to the continuous evolution of DrayTek technology, all routers will be regularly upgraded. Please consult the DrayTek web site for more information on newest firmware, tools and documents.

<http://www.draytek.com>

Table of Contents

1. Introduction.....	1
2. Package Content	2
3. Panel Explanation.....	3
4. Hardware Installation	5
4.1 Network Connection	5
4.2 Wall-Mounted Installation	6
5. Software Configuration	7
6. Customer Service	11

1. Introduction

The Vigor2133 features advanced bandwidth control mechanism such as IP-layer QoS, NAT Session Limitation, Bandwidth Borrowed, etc., to allow easy, flexible, reliable access control and bandwidth management.

The SPI (Stateful Packet Inspection) firewall uses object-based design to make settings of firewall policies easy. The CSM (Content Security Management) feature allows more precise and efficient access control for URL/Web Content Filtering, IM (Instant Messenger) and P2P (Peer to Peer) applications.

Vigor2133 supports up to 2 VPN tunnels using advanced protocols such as IPSec/PPTP/L2TP/L2TP over IPSec with AES/DES/3DES for encryption and MD5/SHA-1 for authentication.

In addition, Vigor2133 supports USB interface for connecting USB printer to share printer or USB storage device for sharing files. Vigor2133 series provides two-level management to simplify the configuration of network connection. The user mode allows user accessing into WEB interface via simple configuration. However, if users want to have advanced configurations, they can access into WEB interface through admin mode.

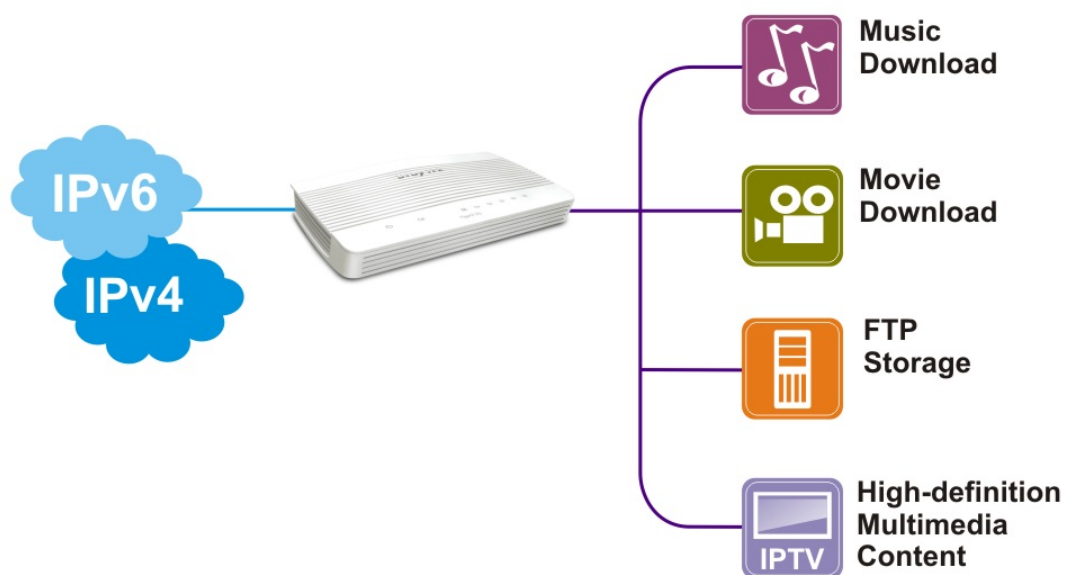

2. Package Content

Take a look at the package content. If there is anything missed or damaged, please contact DrayTek or dealer immediately.



Vigor Router

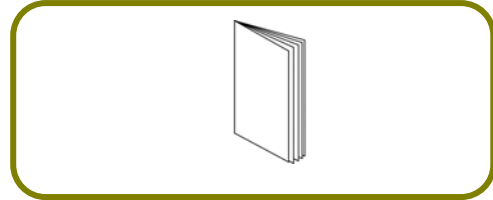

Quick Start Guide



RJ-45 Cat-5 Ethernet Cable

The type of the power adapter depends on the country that the router will be installed. * The maximum power consumption is *17-23 Watt*.

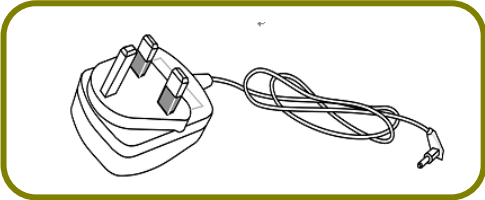

UK-type Power Adapter

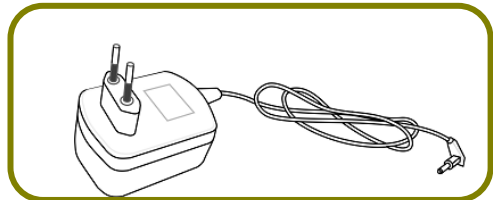

EU-type Power Adapter

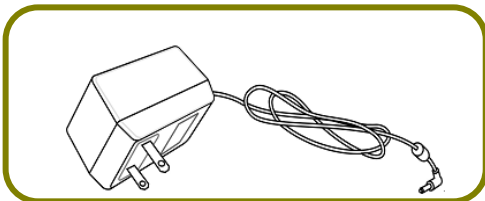



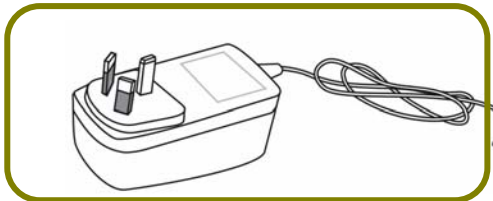



USA/Taiwan-type Power Adapter

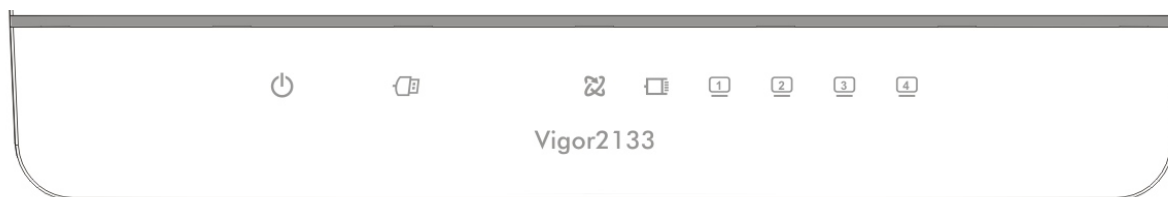

AU/NZ-type Power Adapter

3. Panel Explanation



LED	Status	Explanation
 (Activity)	Blinking	The router is powered on and running normally.
	Blinking	When ACT and WLAN LEDs blink quickly and simultaneously is enabled and the system waits for wireless station of connection.
	Off	The router is powered off.
 USB	On	A USB device is connected and active.
	Blinking	The data is transmitting.
 WAN	On	Internet connection is ready.
	Blinking	The data is transmitting.
	Off	Internet connection is not ready.
	On	The WAN port is connected with Ethernet cable.
	Blinking	The data is transmitting through WAN port.
	Off	The WAN port is disconnected.
 LAN1/2/3/4	On	The LAN port is connected.
	Blinking	The data is transmitting.
	Off	The LAN port is disconnected.

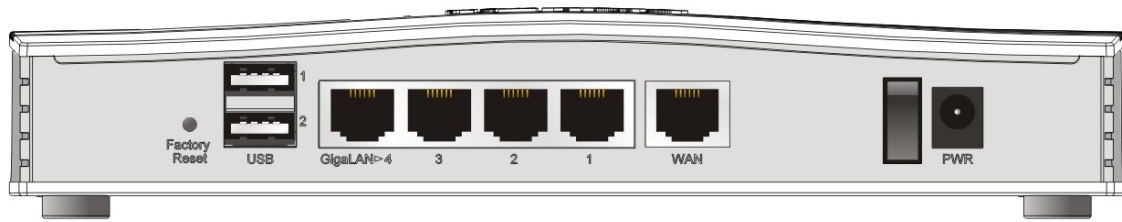

Interface	Description
Factory Reset	Restore the default settings. Usage: Turn on the router (ACT LED is blinking). Press the hole and keep for more than 5 seconds. When you see the ACT LED begins to blink rapidly than usual, release the button. Then the router will restart with the factory default configuration.
USB1~USB2	Connector for a USB device (for 3G/4G USB Modem or printer).
GigaLAN1~LAN4	Connectors for local networked devices.
WAN	Connector for remote networked devices.
ON/OFF	Power Switch.
PWR	Connector for a power adapter.

4. Hardware Installation

This section will guide you to install the router through hardware connection and configure the router's settings through web browser.

Before starting to configure the router, you have to connect your devices correctly.

4.1 Network Connection

1. Connect the cable Modem/DSL Modem/Media Converter to any WAN port of router with Ethernet cable (RJ-45).
2. Connect one port of 4-port switch to your computer with a RJ-45 cable. This device allows you to connect 4 PCs directly.
3. Connect one end of the power cord to the power port of this device. Connect the other end to the wall outlet of electricity.
4. Power on the router.
5. Check the **ACT** and **WAN**, **LAN** LEDs to assure network connection.

(For the detailed information of LED status, please refer to section 3. Panel Explanation)

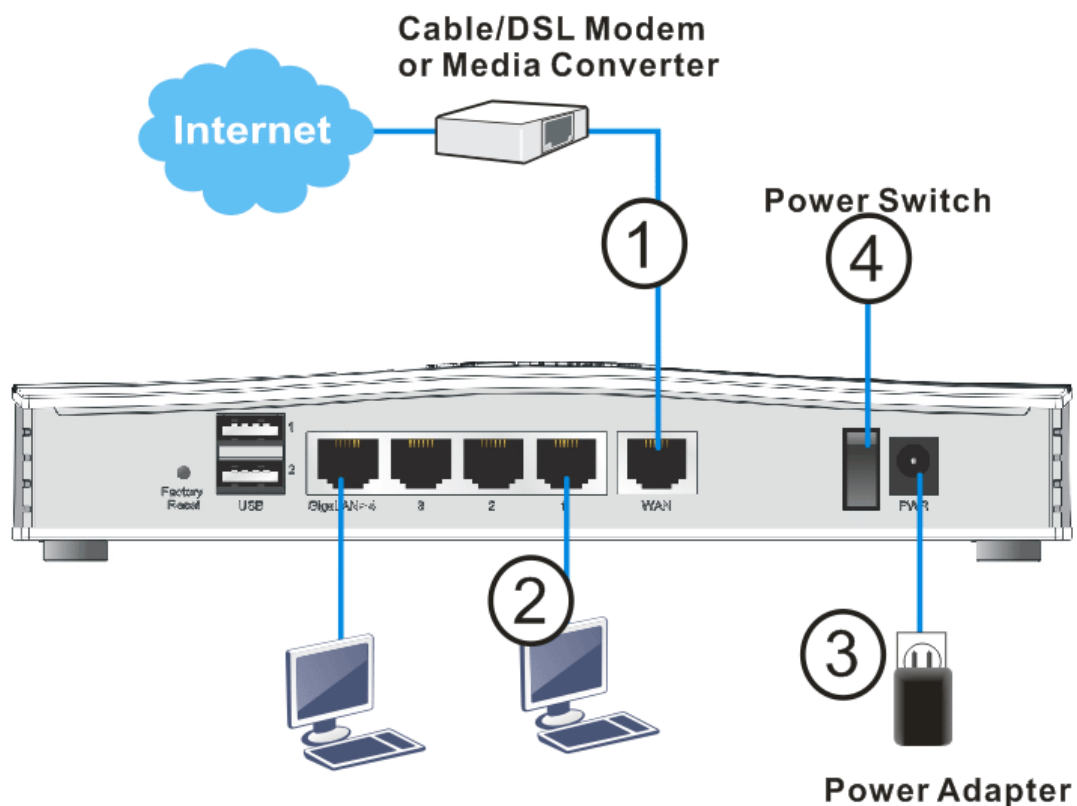

4.2 Wall-Mounted Installation

Vigor2133 has keyhole type mounting slots on the underside.

1. A template is provided on the Vigor2133 packaging box to enable you to space the screws correctly on the wall.
2. Place the template on the wall and drill the holes according to the recommended instruction.
3. Fit screws into the wall using the appropriate type of wall plug.

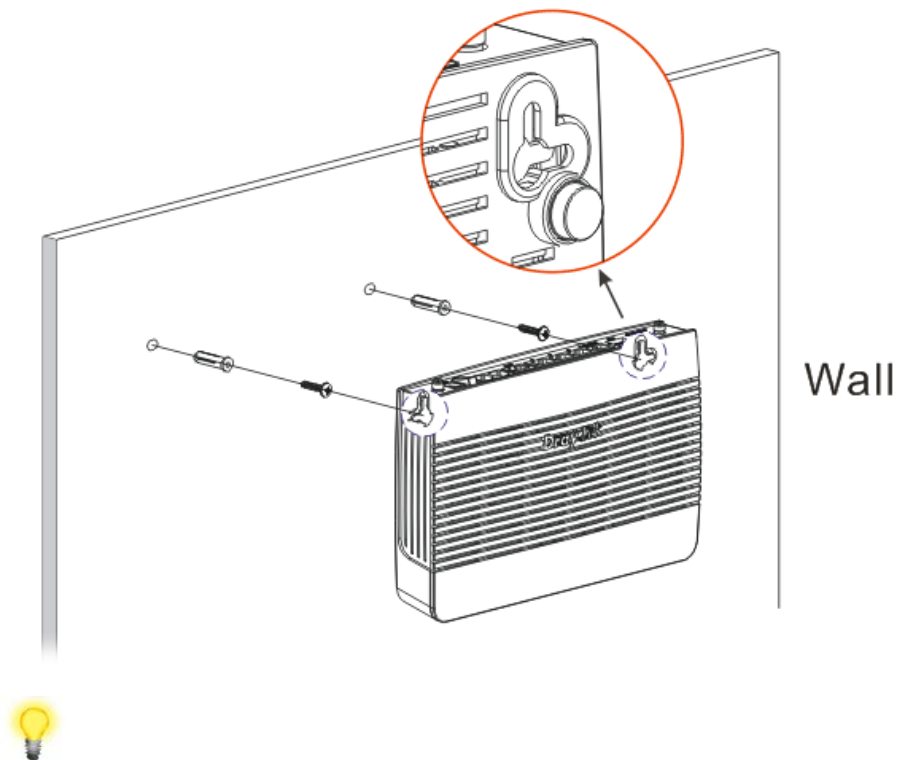

Note

The recommended drill diameter shall be 6.5mm (1/4").

4. When you finished about procedure, the router has been mounted on the wall firmly.

5. Software Configuration

To access Internet, please finish basic configuration after completing the hardware installation.

The **Quick Start Wizard** is designed for you to easily set up your router for Internet access. You can directly access the **Quick Start Wizard** via Web Configurator.

1. Make sure your PC connects to the router correctly.



Note

You may either simply set up your computer to get IP dynamically from the router or set up the IP address of the computer to be the same subnet as the **default IP address of Vigor router 192.168.1.1**. For the detailed information, please refer to the section - Trouble Shooting in the User's Guide.

2. Open a web browser on your PC and type **http://192.168.1.1**. A pop-up window will open to ask for username and password. Please type "admin/admin" as the Username/Password and click **Login**.

DrayTek **Vigor2133 Series**

Login

Username

Password

Login

Copyright © 2000- 2016 DrayTek Corp. All Rights Reserved.

- Now, the Main Screen will pop up. Click **Wizards>>Quick Start Wizard**.

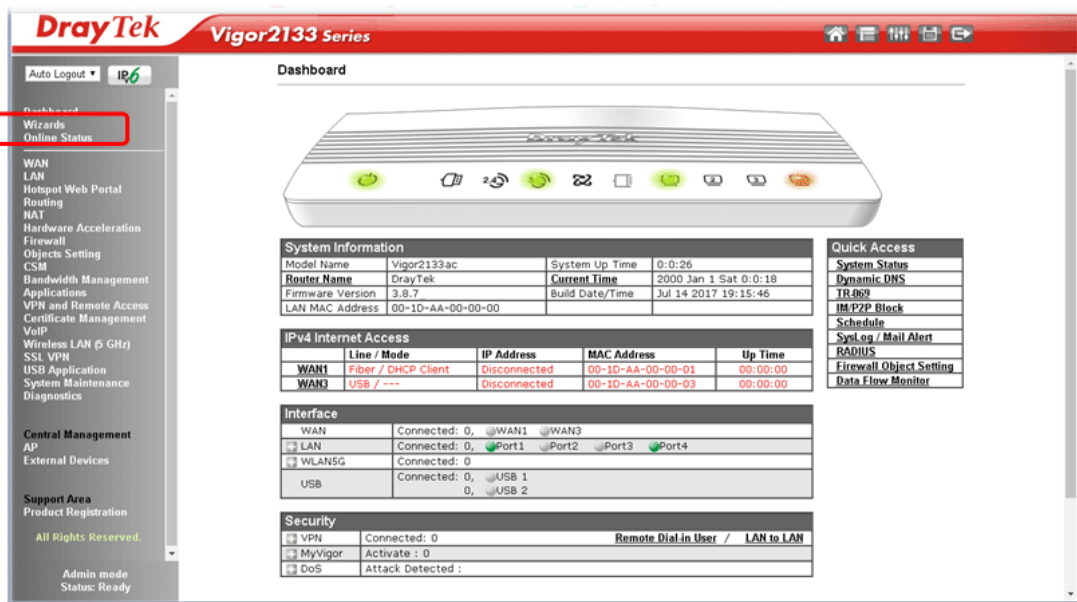

Note

The home page will change slightly in accordance with the router you have.

- Enter the login password on the field of **New Password** and retype it on the field of **Confirm Password**. Then click **Next** to continue.

Quick Start Wizard

Enter login password

Please enter an alpha-numeric string as your **Password** (Max 23 characters).

Old Password

New Password

Confirm Password

Password Strength: Weak Medium Strong

- Strong password requirements:
- Have at least one upper-case letter and one lower-case letter.
 - Including non-alphanumeric characters is a plus.

5. On the next page as shown below, please select the appropriate protocol according to the information from your ISP. For example, you should select PPPoE mode if the ISP provides you PPPoE interface. Then click Next for next step.

Quick Start Wizard

Connect to Internet

WAN 1

Select one of the following Internet Access types provided by your ISP.

- PPPoE
- PPTP
- L2TP
- Static IP
- DHCP

PPPoE: If you click PPPoE as the protocol, after clicking Next, you will get the following web page. Please manually enter the Username/Password provided by your ISP. Then click Next.

Quick Start Wizard

PPPoE Client Mode

WAN 1

Enter the user name and password provided by your ISP.

Service Name (Optional)

Username

Password

Confirm Password

PPTP/L2TP: if you click PPTP/L2TP, you will get the following page. Please type in all the information originally provided by your ISP. Then click Next for next step.

Quick Start Wizard

PPTP Client Mode

WAN 1	
Enter the username, password, WAN IP configuration and PPTP server IP provided by your ISP.	
Username	<input type="text"/>
Password	<input type="password"/>
Confirm Password	<input type="password"/>
WAN IP Configuration	
<input checked="" type="radio"/> Obtain an IP address automatically	
<input type="radio"/> Specify an IP address	
IP Address	<input type="text"/>
Subnet Mask	<input type="text"/>
Gateway	<input type="text"/>
PPTP Server	<input type="text"/>

Static IP: if you click Static IP, you will get the following page. Please type in the IP address information originally provided by your ISP. Then click Next for next step.

Quick Start Wizard

Static IP Client Mode

WAN 1	
Enter the Static IP configuration provided by your ISP.	
WAN IP	<input type="text" value="172.16.3.102"/>
Subnet Mask	<input type="text" value="255.255.255.0"/>
Gateway	<input type="text" value="172.16.3.1"/>
Primary DNS	<input type="text" value="8.8.8.8"/>
Secondary DNS	<input type="text" value="8.8.4.4"/> (optional)

DHCP: if you click DHCP, you will get the following page. Simply click Next to continue.

Quick Start Wizard

DHCP Client Mode

WAN 1

If your ISP requires you to enter a specific host name or specific MAC address, please enter it in.

Host Name (optional)
MAC (optional)

6. Now you can see the following screen. It indicates that the setup is complete. Different types of connection modes will have different summary. Click **Finish** and then restart the router. Afterward, you will enjoy surfing on the Internet.

Quick Start Wizard

Please confirm your settings:

WAN Interface:	WAN1
Physical Mode:	Ethernet
Physical Type:	Auto negotiation
Internet Access:	DHCP

Click **Back** to modify changes if necessary. Otherwise, click **Finish** to save the current settings and restart the Vigor router.

6. Customer Service

If the router cannot work correctly after trying many efforts, please contact your dealer/DrayTek for further help right away. For any questions, please feel free to send e-mail to support@draytek.com.