

Vigor167 35b Modem Quick Start Guide

Version: 1.3

Firmware Version: V5.2.5

(For future update, please visit DrayTek web site)

Date: December 9, 2024

Intellectual Property Rights (IPR) Information

Copyrights	© All rights reserved. This publication contains information that is protected by copyright. No part may be reproduced, transmitted, transcribed, stored in a retrieval system, or translated into any language without written permission from the copyright holders.
Trademarks	The following trademarks are used in this document: <ul style="list-style-type: none">● Microsoft is a registered trademark of Microsoft Corp.● Windows 8, 10, 11 and Explorer are trademarks of Microsoft Corp.● Apple and Mac OS are registered trademarks of Apple Inc.● Other products may be trademarks or registered trademarks of their respective manufacturers.

Safety Instructions and Approval

Safety Instructions	<ul style="list-style-type: none">● Read the installation guide thoroughly before you set up the modem.● The modem is a complicated electronic unit that may be repaired only by authorized and qualified personnel. Do not try to open or repair the modem yourself.● Do not place the modem in a damp or humid place, e.g. a bathroom.● Do not stack the modems.● The modem should be used in a sheltered area, within a temperature range of 0 to +45 Celsius.● Do not expose the modem to direct sunlight or other heat sources. The housing and electronic components may be damaged by direct sunlight or heat sources.● Do not deploy the cable for LAN connection outdoor to prevent electronic shock hazards.● Do not power off the router when saving configurations or firmware upgrades. It may damage the data in a flash. Please disconnect the Internet connection on the router before powering it off when a TR-069/ ACS server manages the router.● Keep the package out of reach of children.● When you want to dispose of the modem, please follow local regulations on conservation of the environment.
Warranty	We warrant to the original end user (purchaser) that the modem will be free from any defects in workmanship or materials for a period of two (2) years from the date of purchase from the dealer. Please keep your purchase receipt in a safe place as it serves as proof of date of purchase. During the warranty period, and upon proof of purchase, should the product have indications of failure due to faulty workmanship and/or materials, we will, at our discretion, repair or replace the defective products or components, without charge for either parts or labor, to whatever extent we deem necessary to restore the product to proper operating condition. Any replacement will consist of a new or re-manufactured functionally equivalent product of equal value and will be offered solely at our discretion. This warranty will not apply if the product is modified, misused, tampered with, damaged by an act of God, or subjected to abnormal working conditions. The warranty does not cover the bundled or licensed software of other vendors. Defects that do not significantly affect the usability of the product will not be covered by the warranty. We reserve the right to revise the manual and online documentation and to make changes from time to time in the contents hereof without obligation to notify any person of such revision or changes.

Model: Vigor167
Power Consumption : 4.4W (Max.)
Power Input: 12V  0.4A
Manufacturer: DrayTek Corporation
Address: No. 26, Fushing Rd, Hukou, Hsinchu Industrial Park, Hsinchu 303, Taiwan



EU Declaration of Conformity

Hereby, DrayTek Corporation declares that the equipment type Vigor167 is in compliance with EU EMC Directive 2014/30/EU, Low Voltage Directive 2014/35/EU and RoHS 2011/65/EU. The full text of the EU Declaration of Conformity is available at the following internet address:

<https://fw.draytek.com.tw/Vigor167/Document/CE/>

- Product name: 35b Modem
- Model number: Vigor167
- Manufacturer: DrayTek Corp.
- Address: No.26, Fushing Rd., Hukou, Hsinchu Industrial Park, Hsinchu 303, Taiwan



Declaration of Conformity

Hereby, DrayTek Corporation declares that the equipment type Vigor167 is in compliance with The Electromagnetic Compatibility Regulations 2016 (SI 2016 No.1091), The Electrical Equipment (Safety) Regulations 2016 (SI 2016 No.1101), and The Restriction of the Use of Certain Hazardous Substances in Electrical and Electronic Equipment Regulations 2012 (SI 2012 No. 3032). The full text of the EU Declaration of Conformity is available at the following internet address:

<https://fw.draytek.com.tw/Vigor167/Document/CE/>

- Product name: 35b Modem
- Model number: Vigor167
- Manufacturer: DrayTek Corp.
- Address: No.26, Fushing Rd., Hukou, Hsinchu Industrial Park, Hsinchu 303, Taiwan
- Importer: UK - CMS Distribution Limited, 15 Worship Street, London, EC2A 2DT
Ireland - CMS Distribution Limited, Bohola Road, Kiltimagh, Co Mayo, Ireland



Regulatory Information

This equipment has been tested and found to comply with the limits for a Class B digital device, pursuant to Part 15 of the FCC Rules. These limits are designed to provide reasonable protection against harmful interference in a residential installation. This equipment generates, uses and can radiate radio frequency energy and, if not installed and used in accordance with the instructions, may cause harmful interference to radio communications. However, there is no guarantee that interference will not occur in a particular installation. If this equipment does cause harmful interference to radio or television reception, which can be determined by turning the equipment off and on, the user is encouraged to try to correct the interference by one of the following measures:

- Reorient or relocate the receiving antenna.
- Increase the separation between the equipment and receiver.
- Connect the equipment into an outlet on a circuit different from that to which the receiver is connected.
- Consult the dealer or an experienced radio/TV technician for help.

This device complies with Part 15 of the FCC Rules. Operation is subject to the following two conditions:

- (1) This device may not cause harmful interference, and
- (2) This device may accept any interference received, including interference that may cause undesired operation.

USA Local Representative	Company name	ABP International Inc.		
	Address	13988 Diplomat Drive Suite 180 Dallas TX 75234		
	ZIP Code	75234	E-mail	henry@abptech.com
	Contact Person	Mr. Henry N Castillo	Tel.	(972)831-1600 140

For more updates, please visit www.draytek.com.

*The external power supply used for each product will be model dependent.

		1	2	3	4	5	6	7	8	9	10	11	12
A	Manufacturer	CWT	CWT	CWT	CWT	CWT	APD	APD	APD	APD	MOSO	MOSO	MOSO
B	Address	No. 222, Sec 2, Nankan Rd., Lujhu Township, Taoyuan County 338, Taiwan	No. 222, Sec 2, Nankan Rd., Lujhu Township, Taoyuan County 338, Taiwan	No. 222, Sec 2, Nankan Rd., Lujhu Township, Taoyuan County 338, Taiwan	No. 222, Sec 2, Nankan Rd., Lujhu Township, Taoyuan County 338, Taiwan	No. 222, Sec 2, Nankan Rd., Lujhu Township, Taoyuan County 338, Taiwan	No. 5, Lane 83, Lung-Sou St., Taoyuan City 330, Taiwan	No. 5, Lane 83, Lung-Sou St., Taoyuan City 330, Taiwan	No. 5, Lane 83, Lung-Sou St., Taoyuan City 330, Taiwan	No. 5, Lane 83, Lung-Sou St., Taoyuan City 330, Taiwan	Sangtai Industrial Park, Guanwai Xiaobaimang Songbai Road, Nanshan District, 518108 Shenzhen, Guangdong, China	Sangtai Industrial Park, Guanwai Xiaobaimang Songbai Road, Nanshan District, 518108 Shenzhen, Guangdong, China	Sangtai Industrial Park, Guanwai Xiaobaimang Songbai Road, Nanshan District, 518108 Shenzhen, Guangdong, China
C	Model identifier	2ABB012F UK	2ABB018F UK	2ABL024F UK	2ABL030F UK	2ABN036F UK	WA-12M12FG	WB-18D12FG	WA-24Q12FG	WA-36A12FG	MS-V2000R120-024Q0-GB	MSS-V2500WR120-030E0-GB	V30-V3000R120-0-036T0-GB
		2ABB012F EU	2ABB018F EU	2ABL024F EU	2ABL030F EU	2ABN036F EU	WA-12M12FK	WB-18D12FK	WA-24Q12FK	WA-36A12FK	MS-V2000R120-024Q0-DE	MSS-V2500WR120-030E0-DE	V30-V3000R120-0-036T0-DE
D	Input voltage	100-240V	100-240V	100-240V	100-240V	100-240V	100-240V	100-240V	100-240V	100-240V	100-240V	100-240V	100-240V
E	Input AC frequency	50/60Hz	50/60Hz	50/60Hz	50/60Hz	50/60Hz	50/60Hz	50/60Hz	50/60Hz	50/60Hz	50/60Hz	50/60Hz	50/60Hz
	Output voltage DC	12.0V	12.0V	12.0V	12.0V	12.0V	12.0V	12.0V	12.0V	12.0V	12.0V	12.0V	12.0V
F	Output current	1.0A	1.5A	2.0A	2.5A	3.0A	1.0A	1.5A	2.0A	3.0A	2.0A	2.5A	3.0A
G	Output power	12.0W	18.0W	24.0W	30.0W	36.0W	12.0W	18.0W	24.0W	36.0W	24.0W	30.0W	36.0W
H	Average active efficiency	84.9%	86.2%	87.6%	87.8%	89.8%	83.7%	85.4%	88.6%	88.2%	87.8%	89.5%	89.3%
I	Efficiency at low load 10%	73.6%	78.0%	81.3%	83.3%	83.7%	74.5%	80.5%	86.4%	85.4%	85.4%	84.7%	87.7%
J	No-load power consumption	0.07W	0.07W	0.07W	0.07W	0.07W	0.07W	0.10W	0.07W	0.10W	0.10W	0.08W	0.10W

External power supply (Power Adapter) information. For more updates, please visit www.draytek.com.



Table of Contents

1. Package Content	1
2. Panel Explanation.....	2
3. Hardware Installation	3
3.1 Network Connection	3
3.2 Wall-Mounted Installation	4
4. Software Configuration	5
5. Customer Service	9

1. Package Content

Take a look at the package content. If there is anything missed or damaged, please contact DrayTek or dealer immediately.



Modem

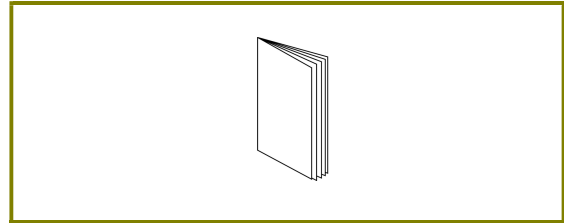

Quick Start Guide

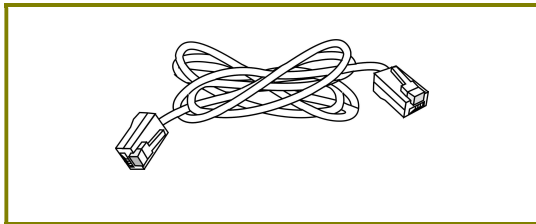

RJ-45 Cable (Ethernet)

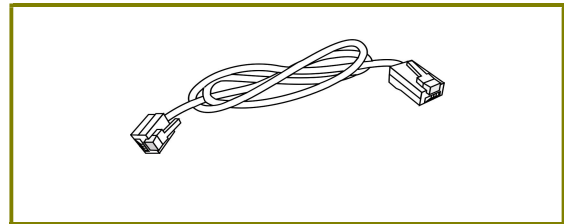

RJ-11 to RJ-11 Cable or RJ-11 to RJ-45 Cable

The type of the power adapter depends on the country that the modem will be installed. * The maximum power consumption is **4.8 Watt**.

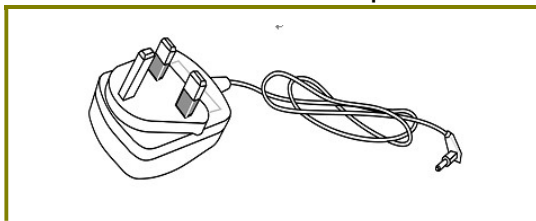

UK-type Power Adapter

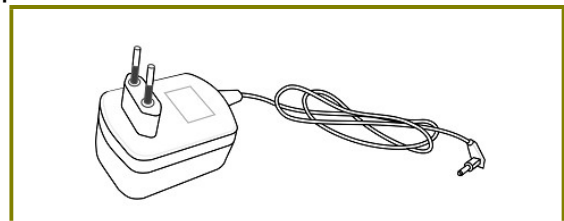

EU-type Power Adapter

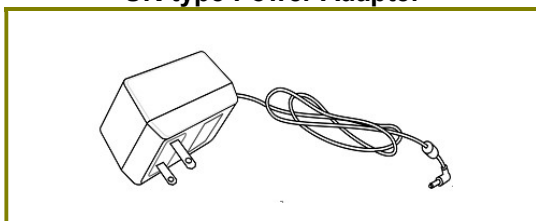

USA/Taiwan-type Power Adapter

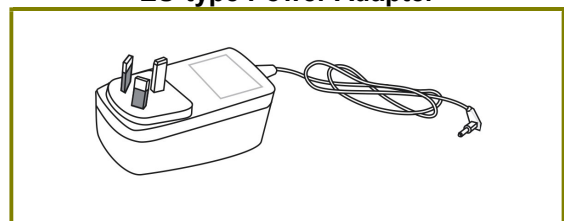

AU/NZ-type Power Adapter

2. Panel Explanation

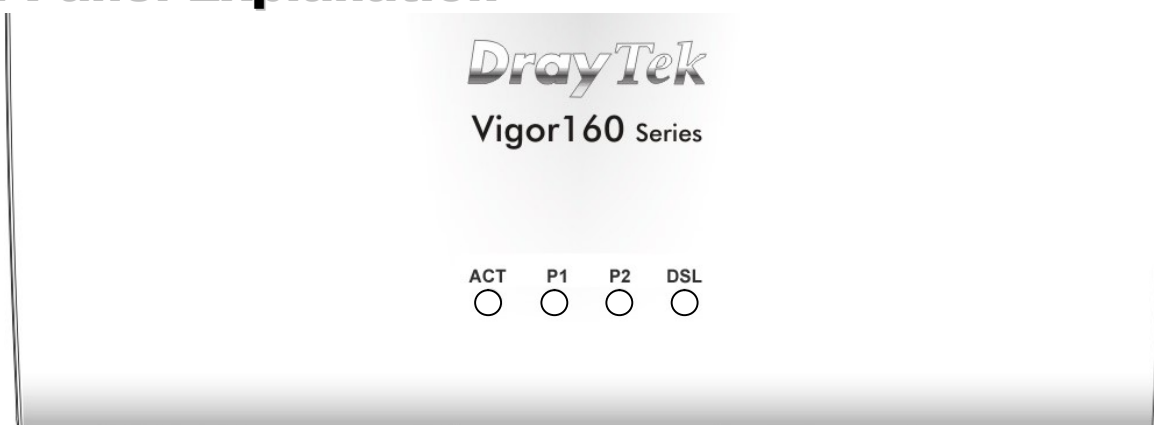

LED	Status	Explanation
ACT	Off	The system is not ready or is failed.
	Blinking	The system is ready and can work normally.
P1/P2	On	A normal connection is through its corresponding port.
	Off	LAN is disconnected.
	Blinking	Data is transmitting (sending/receiving).
DSL	On	xDSL connection synchronized.
	Blinking	xDSL connection is synchronizing.

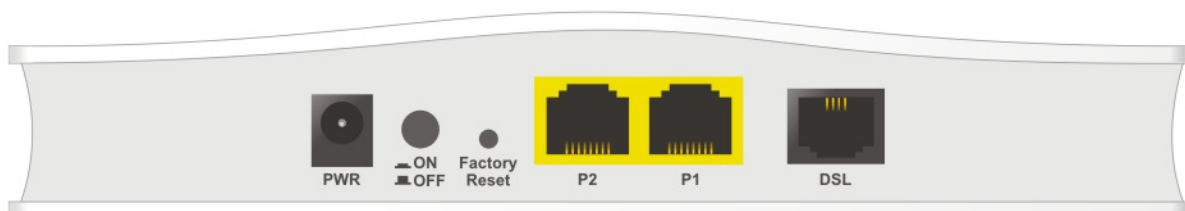

Interface	Description
PWR	Connector for a power adapter.
ON/OFF	ON/OFF: Power switch.
Factory Reset	Restore the default settings. Usage: Turn on the modem. Press the button and keep for more than 10 seconds. Then the modem will restart with the factory default configuration.
P2-P1	Connector for local networked devices.
DSL	Connector for accessing the Internet through xDSL.



Note

Remove the protective film from the router before use to ensure ventilation.

3. Hardware Installation

This section will guide you to install the modem through hardware connection and configure the modem's settings through web browser.

Before starting to configure the modem, you have to connect your devices correctly.

3.1 Network Connection

1. Connect the DSL interface to the MODEM port of external splitter with a DSL line cable.

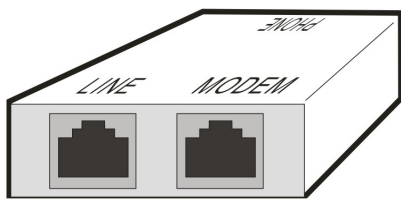

(splitter)

2. Connect the LAN port to your computer with a RJ-45 cable.
3. Connect one end of the power adapter to the Power port of this device. Connect the other end to the wall outlet of electricity.
4. Power on the modem.
5. Check the POWER, ACT, LAN, DSL and INTERNET LEDs to assure network connections.

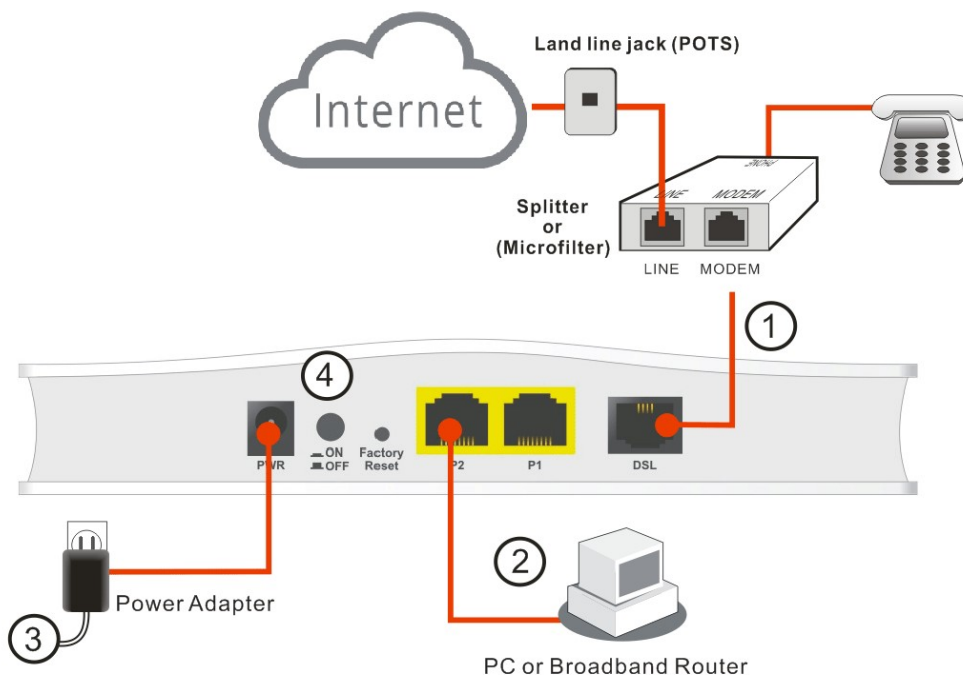

(For detailed information on LED status, please refer to section 2.)

3.2 Wall-Mounted Installation

Vigor167 has keyhole type mounting slots on the underside.

1. Drill the holes on the wall according to the recommended instruction.
2. Fit screws into the wall using the appropriate type of wall plug.

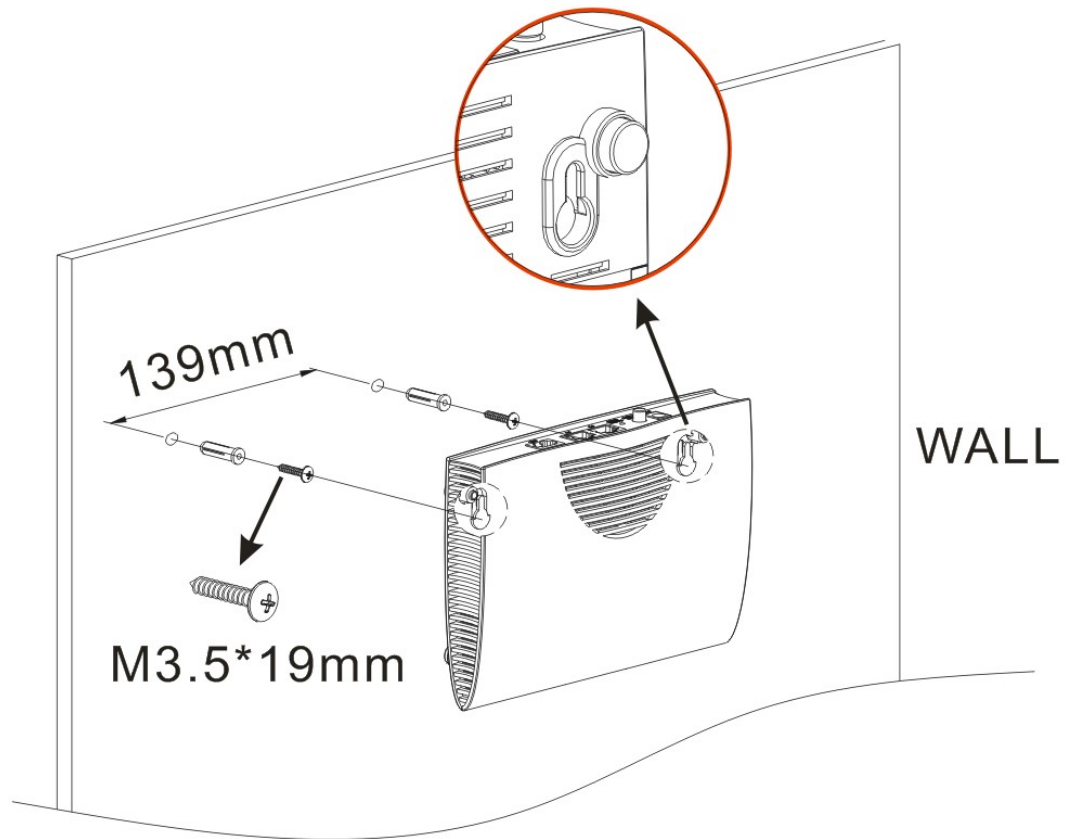

Note

The recommended drill diameter shall be 6.5mm (1/4").

3. When you finished the above procedure, the modem has been mounted on the wall firmly.

4. Software Configuration

To access the Internet, please finish the basic configuration after completing the hardware installation.

1. Make sure your PC connects to this device correctly.
2. Open a web browser on your PC and type **http://192.168.1.1**. A pop-up window will open to ask for a username and password. Please type “admin/admin” as the Username/Password and click **Login**.

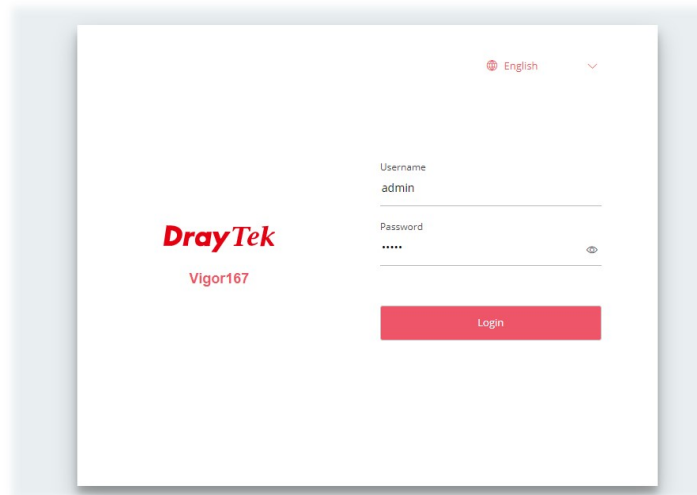

Note

Please set up the IP address of the computer to be the same subnet as the default IP address of Vigor device **192.168.1.1**.

3. Next, the page will appear to guide you change the login password.

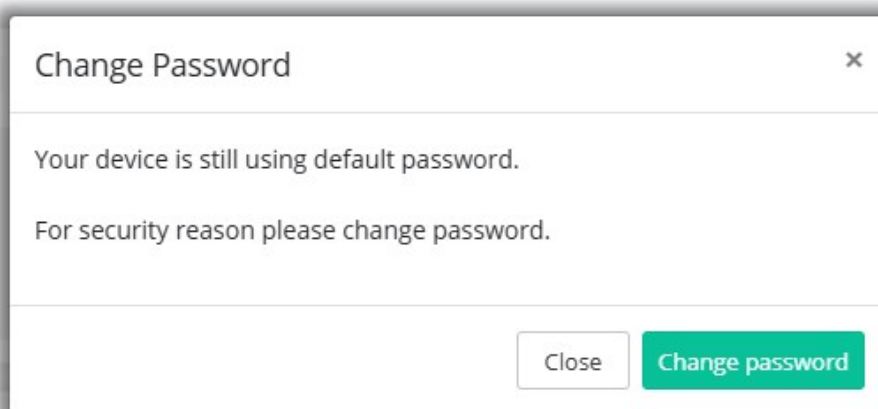

4. You **MUST** change the login password before accessing the web user interface. Please set a new password for network security.

admin / Set Password

Account admin

Current Password [password field]

New Password [password field]

Confirm New Password [password field]

Medium

Apply

5. After clicking **Apply**, the Main Screen will pop up.

DrayTek Vigor167

System Time : 2021-01-01 00:01:27

admin

Dashboard

PORT STATUS

10M/100M/ADSL 1G/VDSL

Name	TX Packets	RX Packets	TX Bytes	RX Bytes
[LAN] LAN1	6022	1855	8.3 MB	129.2 KB

SYSTEM

Device Name: DrayTek
LAN MAC: 14:49:BC:5E:C7:94
System Uptime: 0d 0h: 1m: 52s
Firmware: 5.2.5
ACS Server: [red dot]

DSL INFORMATION

Status: Idle
Mode: DSL
Profile: --
Annex: --
DSL Version: S.12.31.0_A_A60901
Line Uptime: 0d 0h 0m 0s
Downstream Line Rate: --
Upstream Line Rate: --
SNR Downstream: --
SNR Upstream: --

SYSTEM USAGE

6. Open **Operation Mode** to open the following page. Select **Modem Mode** and click **Next**.

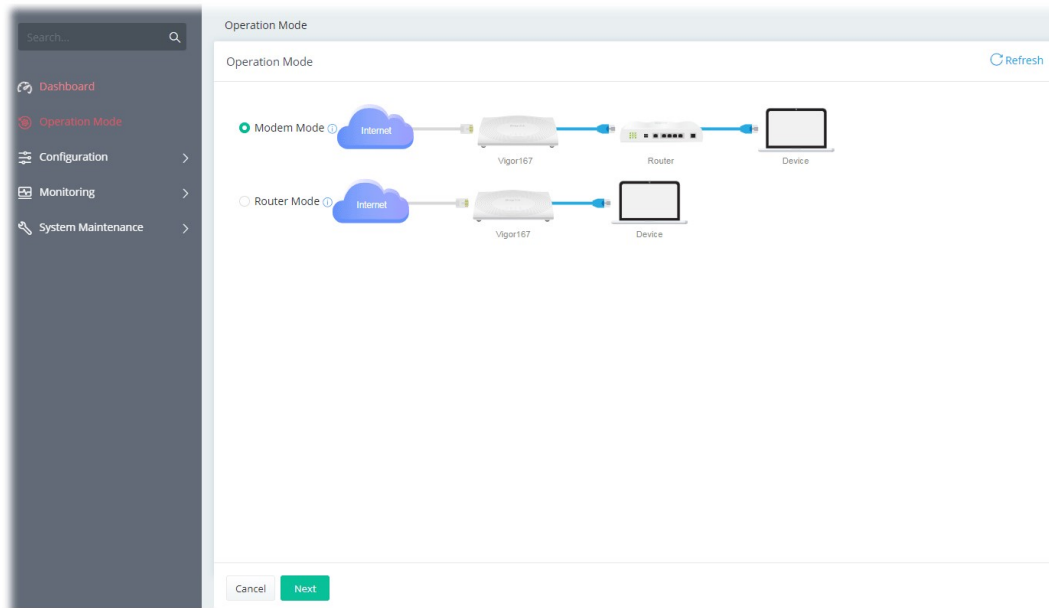

7. In this page, configure the system time settings. Then click **Next**.

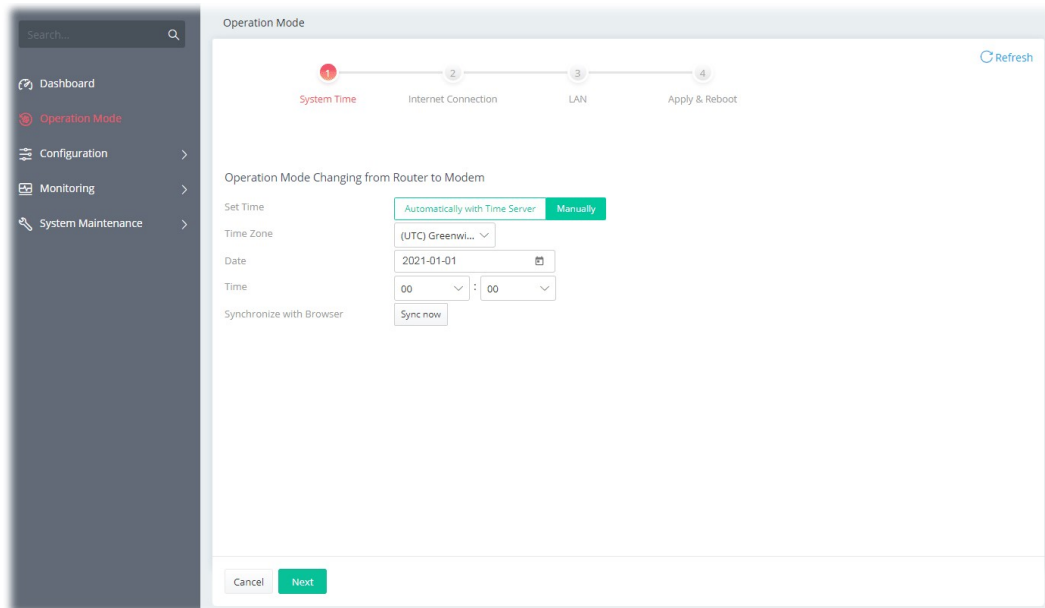

- For the Internet connection, configure the settings based on the information from your ISP. Then click **Next** to get the next page.

The screenshot shows the 'Internet Connection' configuration page. At the top, a progress bar indicates four steps: 1. System Time, 2. Internet Connection (current), 3. LAN, and 4. Apply & Reboot. Below the progress bar, the text reads 'Operation Mode Changing from Router to Modem'. The 'General' section includes 'Physical Interface' set to 'DSL' and 'DSL Mode' set to 'Auto'. The 'ADSL Setting' section includes 'Annex' set to 'Auto', 'VPI (0-255)' set to '0', 'VCI (32-65535)' set to '32', and 'Customer VLAN' set to 'Off'. The 'VDSL2 Setting' section includes 'Customer VLAN' set to 'Off'. At the bottom, there are 'Back' and 'Next' buttons.

- From the following page, change LAN settings if required. Then click **Next**.

The screenshot shows the 'LAN' configuration page. At the top, the progress bar now highlights step 3, 'LAN'. The text reads 'Operation Mode Changing from Router to Modem'. The 'Network Configuration' section includes 'IP Address' set to '192.168.1.1' and 'Subnet Mask' set to '255.255.255.0'. The 'DHCP Server Configuration' section includes 'DHCP Server' set to 'Off', 'Primary DNS' and 'Secondary DNS' fields, and a note: 'Note: DNS servers are optional and used when local services reaching remote server by domain name via LAN interface.' At the bottom, there are 'Back' and 'Next' buttons.

- Now, click **Apply & Reboot** to activate the settings.

The screenshot shows the 'Apply & Reboot' confirmation page. At the top, the progress bar highlights step 4, 'Apply & Reboot'. The text reads 'Congratulations' and 'Please reboot router to apply new operation mode settings.' At the bottom, there are 'Back' and 'Apply & Reboot' buttons.

5. Customer Service

If the modem still cannot work correctly after trying many efforts, please contact your dealer for further help right away. For any questions, please feel free to send an e-mail to support@draytek.com.

Be a Registered Owner

Web registration is preferred. You can register your Vigor modem via <https://myvigor.draytek.com>.

Firmware & Tools Updates

Due to the continuous evolution of DrayTek technology, all devices will be regularly upgraded. Please consult the DrayTek website for more information on the newest firmware, tools, and documents.

<https://www.draytek.com>